

**KVH Industries, Inc.**

# TracPhone® V3IP



**User's Guide**

# TracPhone V3-IP

## User's Guide

This user's guide provides all of the basic information you need to operate, set up, troubleshoot, and maintain the TracPhone V3-IP system. For detailed installation information, please refer to the TracPhone V3-IP Installation Guide.

If you have any comments regarding this manual, please email them to [manuals@kvh.com](mailto:manuals@kvh.com). Your input is greatly appreciated!



### Technical Support

#### Within the Continental U.S.A.:

Phone: 1 866 701-7103

Email: [mvbsupport@kvh.com](mailto:mvbsupport@kvh.com)

#### North/South America, Australia:

Phone: +1 401 851-3806

Email: [mvbsupport@kvh.com](mailto:mvbsupport@kvh.com)

#### Europe, Middle East, Asia, Africa:

Phone: +45 45 160 180

Email: [mvbsupport@kvh.com](mailto:mvbsupport@kvh.com)



KVH Part # 54-0890 Rev. F

© 2013-2016, KVH Industries, Inc., All rights reserved.



## **Trademark Information**

TracPhone, KVH, CommBox, IP-MobileCast, OneCare, and the unique light-colored dome with dark contrasting baseplate are trademarks of KVH Industries, Inc.  
mini-VSAT Broadband is a service mark of KVH Industries, Inc.  
ViaSat and the ViaSat logo are registered trademarks of ViaSat, Inc.  
All other trademarks are the property of their respective owners.

## **Disclaimer**

Every effort has been made to ensure the correctness and completeness of the material in this document. No company shall be liable for errors contained herein. The information in this document is subject to change without notice. No warranty of any kind is made with regard to this material, including, but not limited to, the implied warranties of merchantability and fitness for a particular purpose.

# Table of Contents

## 1 Introduction

About this Manual .....	3
Who Should Use this Manual .....	3
Icons Used in this Manual .....	3
Typographical Conventions .....	3
Related Documentation .....	4
Important Safety Information .....	5
RF Radiation Hazard Area.....	6
System Overview .....	7
System Components.....	8
Satellite Communications .....	9
Seamless Satellite Switching .....	11

## 2 Getting Started

Service Activation .....	15
Contacting the Satellite Airtime and Product Activation Department.....	15
Turning On the System .....	16
System Startup .....	17
Accessing the Web Interface .....	18
Understanding the Home Page .....	19
Accessing the myKVH Web Portal.....	20
Viewing the Help (User Documentation) .....	21
Clearing the Cache of Your Web Browser.....	22

<b>3</b>	<b>Interface Preferences</b>	
	Changing the Administrator Password .....	25
	Entering the Vessel Name.....	26
	Assigning the Phone Line Name .....	27
	Adjusting the LCD Brightness .....	28
<b>4</b>	<b>No-Transmit Zones</b>	
	No-Transmit Zones Overview.....	31
	Status of No-Transmit Zones .....	32
	Establishing No-Transmit Zones .....	33
	Disabling No-Transmit Zones.....	35
	Clearing No-Transmit Zones .....	36
<b>5</b>	<b>Tracking Avoidance Zones</b>	
	Tracking Avoidance Zones Overview .....	39
	Setting Up Tracking Avoidance Zones .....	40
	Disabling Tracking Avoidance Zones .....	45
	Clearing Tracking Avoidance Zones.....	46
<b>6</b>	<b>Voice Connections</b>	
	Voice Service Overview.....	49
	How the Voice Service Works.....	49
	Making a Ship-to-Shore Call.....	50
	Making a Shore-to-Ship Call.....	52
	Virtual Numbers .....	53
	VoiceMail .....	54
	Recording a VoiceMail Personal Greeting.....	54
	Listening to Your VoiceMail Messages .....	54



Faxing .....	56
UCH-250 Fax Server .....	57
Accessing Your Voice Account .....	58

## **7 Network Configuration**

Selecting a Network Configuration .....	61
Standard Configuration.....	64
Static IP Configuration .....	66
Crew Configurations .....	70
Dual Dome Configuration.....	74
Legacy Configuration.....	77
Compatible Configurations for Media Server.....	78
Wireless Settings.....	79
Configuring Computers for DHCP.....	81
Windows 10 DHCP Settings.....	81
Windows 8 DHCP Settings.....	82
Windows 7 or Windows Vista DHCP Settings .....	83
Windows XP DHCP Settings .....	84
Mac OS X DHCP Settings.....	86
LAN Settings on ICM .....	87
Cache Settings on ICM.....	88
Setting Up Data Usage Alerts.....	89
CommBox Settings on ICM .....	90
Reset to Factory Configuration .....	91

## **8 Data Connections**

Internet Access Overview .....	95
Connecting to the Internet.....	96

Tips for Minimizing Data Usage .....97

    Preventing Automatic Updates .....98

    Disabling Automatic File Backup and Synchronization .....98

    Firewall Protection .....99

    Web Browser Settings .....99

    Data-Intensive Applications.....100

    Mobile Websites .....100

    Disabling Wi-Fi Access on Mobile Devices.....100

    Email Best Practices.....101

CommBox Features.....102

    Accessing the CommBox Web Interface.....102

IP-MobileCast Features.....104

    Accessing the IP-MobileCast Web Interface.....104

**9 Troubleshooting**

Initial Steps for Any Problem .....107

Troubleshooting a Voice Problem .....109

Troubleshooting a Data Problem.....111

Error and Warning Messages.....113

Status Information .....117

    Status Information on the Web Interface.....117

    Status Information on the ICM Front Panel LCD .....123

LED Indicators.....127

System Logs .....129

    Operational Log .....129

    Event Log.....130

Equipment ID Numbers .....131

Software Versions.....132

OneCare Customer Support .....133

    Contacting KVH Technical Support.....134

## **10 Maintenance**

Preventative Maintenance .....	137
Software Updates .....	139
Using the ICM to Update Software .....	140
Using Your Computer to Update Software.....	141
Using an iPhone/iPod touch to Update Software.....	142
Using a USB Flash Drive to Update Software .....	143
Modem Configuration Updates .....	144
Manually Updating the Modem Configuration Files .....	145
Corrective Maintenance.....	149
Gyro Calibration .....	150
Hardware Restart .....	152

## **A Wiring Diagram**

Wiring Diagram.....	155
---------------------	-----

## **B LCD Menus**

LCD Menus Quick Reference Guide .....	159
---------------------------------------	-----

## **C Specifications**

System Specifications .....	163
-----------------------------	-----

## **D Glossary**

Glossary .....	167
----------------	-----

## **E Index**

Index.....	181
------------	-----





# 1. Introduction

This section provides important safety information you need to know before using the system. It also provides a basic overview of the system and satellite communications.

## Contents

About this Manual.....	3
Important Safety Information .....	5
System Overview .....	7
Satellite Communications.....	9



## About this Manual

This manual provides complete operation, configuration, and troubleshooting information for the TracPhone V3-IP system.

### Who Should Use this Manual

The **user** should refer to this manual to learn how to operate the system, configure all aspects of the system, and identify the cause of any problem.

The **installer** should refer to this manual for information on setting up the system for the user's desired preferences.

The **servicing technician** should refer to this manual to help identify the cause of a system problem.

### Icons Used in this Manual

This manual uses the following icon:

Icon	Description
	This is a danger, warning, or caution notice. Be sure to read these carefully to avoid injury!

### Typographical Conventions

This manual uses the following typographical conventions:

Text Example	Description
Press <b>MENUS</b> to view the menu.	Name of ICM buttons
At the confirmation message, click <b>Save</b> .	Element of a graphical user interface
<b>SELECT SATELLITES</b>	Text as it appears on the ICM display
See <a href="#">"Using this Manual" on page 3</a> .	Cross-reference to another chapter in the manual
Visit <a href="http://www.kvh.com/mvbservice">www.kvh.com/mvbservice</a> for details.	Cross-reference to a website

## Related Documentation

In addition to this User's Guide, the following documents are provided with your TracPhone system:

Document	Description
Installation Guide	Complete installation instructions
Quick Start Guide	Handy quick reference guide with basic operating instructions
Activation Checklist	Details on activating the system for mini-VSAT Broadband service
Installation Checklist	Form that the installer must return to validate the quality of the installation
Antenna Mounting Template	Template that the installer uses to lay out the antenna mounting holes
Warranty Statement	Warranty terms and conditions
Kitpack Contents List	List of every part supplied in the kit

## Important Safety Information

For your own safety, and for the safety of your passengers and/or crew, be sure to read the following important notices.



### WARNING

#### Risk of Electric Shock

Potentially lethal voltages are present within the ICM. To avoid electric shock, do not open the chassis enclosure.



### WARNING

#### Risk of Electric Shock

If any component of the TracPhone system becomes damaged and/or no longer functions normally, disconnect it from vessel power, secure it from unintended operation, and contact KVH Technical Support (see [“Contacting KVH Technical Support”](#) on page 134). All repairs or modifications must be performed by a trained, KVH-certified technician.



### WARNING

#### Risk of Explosion

Do not operate the ICM (or any other electrical device) in an environment where flammable gases, vapors, or dusts are present.



### WARNING

#### Risk of Electric Shock

Failure to ground the TracPhone system properly to ship's ground will cause an unsafe floating ground condition, risking potentially lethal electric shock. Refer to the Installation Guide for details on the proper grounding of the equipment.



## CAUTION

### RF Radiation Hazard

The antenna transmits up to 3 watts of radio frequency (RF) energy that is potentially harmful. Whenever the system is powered on, make sure everyone stays more than 32 feet (10 m) away from the antenna. No hazard exists directly below the antenna.

## RF Radiation Hazard Area

Since a person above deck may not know which direction the antenna is pointing, you should always observe the minimum safe distance to prevent RF radiation exposure. Within the antenna's elevation range, the minimum safe distance is 32 feet (10 m). No hazard exists directly below the antenna.

Figure 1-1 Minimum Safe Distance to Avoid Risk of RF Radiation Exposure

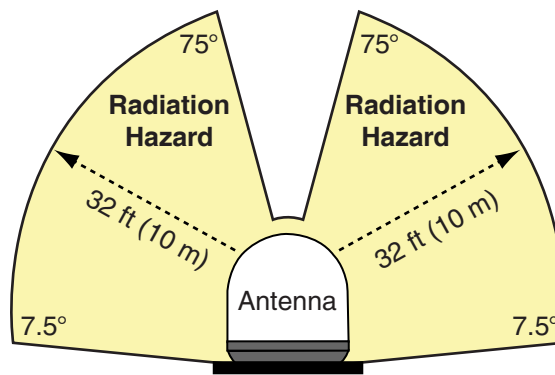

*NOTE: You can set up no-transmit zones to inhibit transmissions within areas frequented by passengers and/or crew. See ["Establishing No-Transmit Zones"](#) on page 33 for details.*

## System Overview

Your TracPhone V3-IP is a complete mini-VSAT Broadband communications system for mariners on the move. Using cutting-edge CRMA (code reuse multiple access) and spread spectrum technologies, the TracPhone V3-IP delivers a seamless and consistent Internet experience. And it all comes with an antenna that is smaller and lighter than traditional VSAT antennas.

The system consists of an antenna and Integrated CommBox Modem (ICM) that connect to a land-based hub via a Ku-band satellite. The hub, managed by a Network Operations Center (NOC), then provides the link to the Internet and the terrestrial telephone network.

*NOTE: A detailed wiring diagram is provided in "Wiring Diagram" on page 155.*

Figure 1-2 TracPhone V3-IP mini-VSAT Broadband Network Diagram

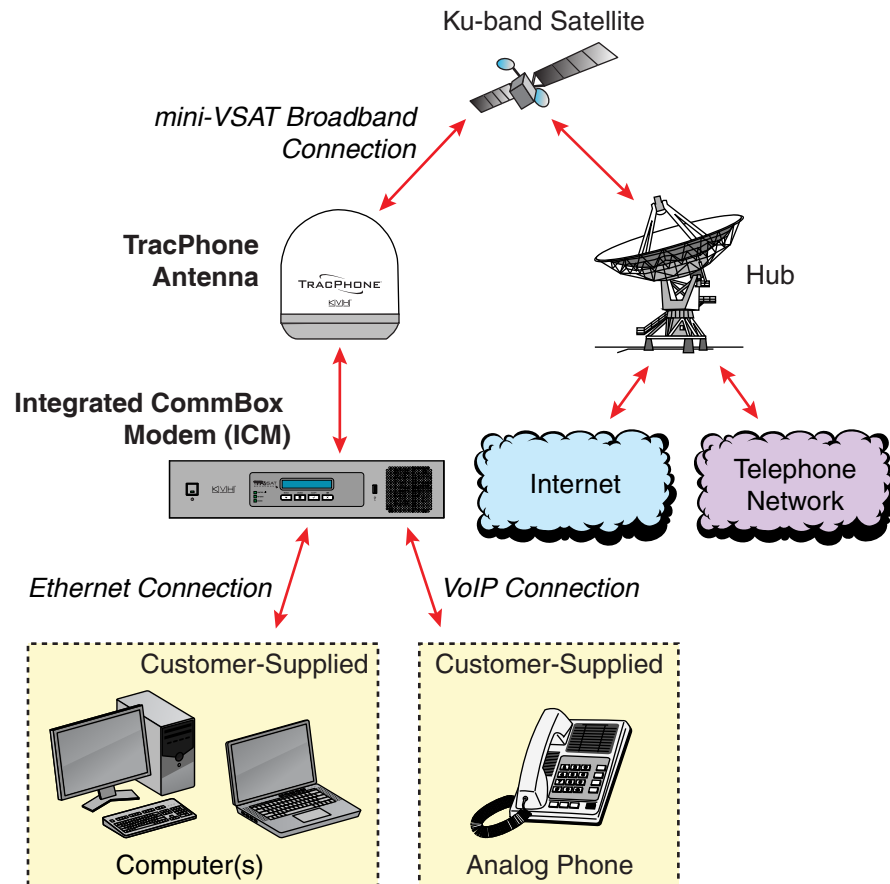

## System Components

The TracPhone V3-IP system includes the following components:

### Antenna Unit

The antenna unit provides the satellite link to the land-based hub. Using its integrated GPS, advanced reflector technology, and gyro stabilization, the antenna automatically locates and tracks the correct satellite, even while your vessel is on the move.

Figure 1-3 Antenna Unit



### Integrated CommBox Modem (ICM)

The ICM is the transceiver and “brain” of the system. Its built-in modem processes all incoming and outgoing data traffic using its proprietary spread spectrum technologies. Its built-in router and wireless access point (WAP) provide the connection to your onboard local area network (LAN). And its easy-to-use web interface and front panel LCD allow you to operate and configure all aspects of the system.

Figure 1-4 ICM

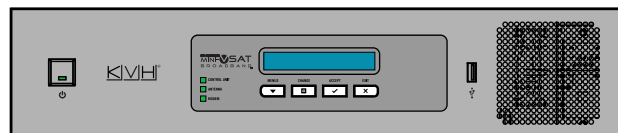

## Satellite Communications

Communications satellites are located in fixed positions above the Earth's equator and relay data to/from the earth within the regions that they serve. Therefore, to communicate via a given satellite, you must be located within that satellite's unique coverage area, also known as its "footprint."

To view the latest mini-VSAT Broadband satellite coverage map, visit KVH's website at [www.kvh.com/minivsatmap](http://www.kvh.com/minivsatmap). The map is an amalgamation of all of the individual satellites' coverage areas.

Figure 1-5 Example of a Satellite Footprint

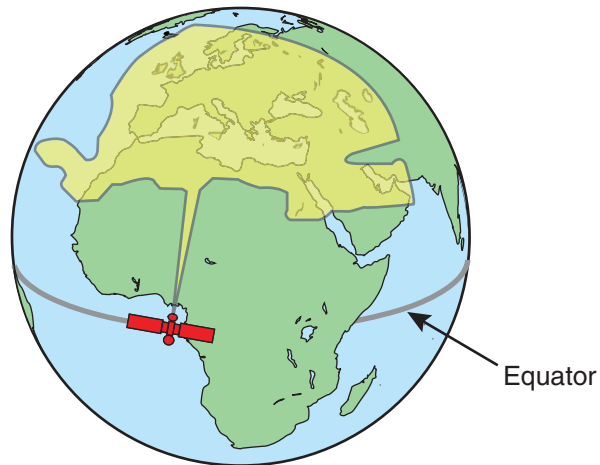



In addition, since satellites are located 22,300 miles (35,900 km) above the equator, the TracPhone antenna must have a clear view of the sky to transmit and receive signals. Anything that stands between the antenna and the satellite can block signals, resulting in lost data.

Common causes of blockage include the following:

- Trees, buildings, and bridges
- Other vessels docked alongside your vessel
- Onboard masts, antennas, or other structures
- Inclement weather conditions

Figure 1-6 Example of Satellite Blockage

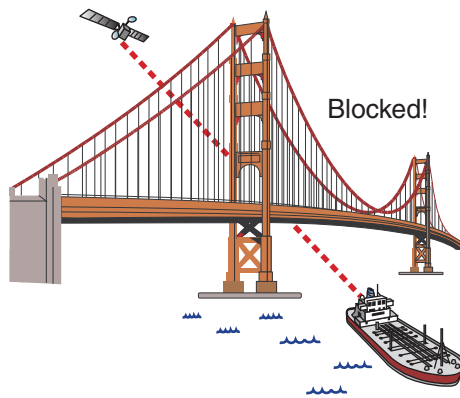

## Seamless Satellite Switching

The high-traffic regions of the global mini-VSAT Broadband coverage area are covered by more than one satellite. The ICM's built-in modem maintains a prioritized list of all satellites in the network and selects the highest priority satellite that provides coverage at the vessel's current GPS location. If the antenna is unable to track the chosen satellite for any reason (due to a blockage condition, for example), the modem selects the next available satellite on the list and the antenna automatically switches to that satellite.

In addition, whenever the vessel travels outside the boundary of the current satellite's coverage area, the modem selects the highest priority satellite in the adjoining region and the antenna automatically switches to that satellite to maintain the service connection.

Figure 1-7 Example of Automatic Satellite Switching

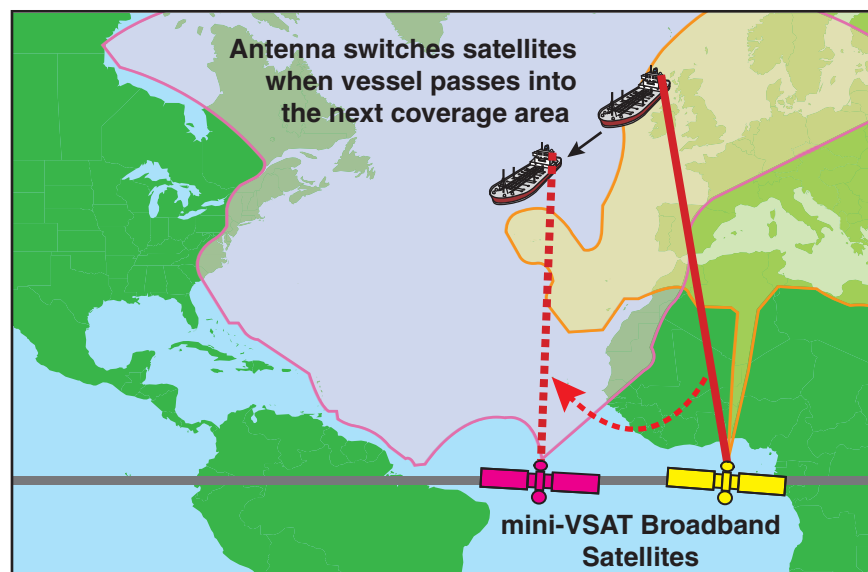

*NOTE: The coverage areas shown here are for illustration purposes only. They do not represent boundaries of actual coverage areas.*



# 2. Getting Started

This section provides you with the fundamental things you need to know to start using the system. It explains how to activate the system for mini-VSAT Broadband service, how to turn on the system for the first time, and how to interpret the system's startup screens. It also introduces the TracPhone V3-IP web interface and myKVH web portal, and details how to access the Help documentation.

## Contents

Service Activation.....	15
Turning On the System.....	16
System Startup.....	17
Accessing the Web Interface.....	18
Understanding the Home Page.....	19
Accessing the myKVH Web Portal.....	20
Viewing the Help (User Documentation).....	21



## Service Activation

Before you can start using the TracPhone system, you need to activate it for mini-VSAT Broadband service. To activate, fill out and submit the appropriate form(s) available at [www.kvh.com/mvbservice](http://www.kvh.com/mvbservice).

*NOTE: You will need to enter the antenna and ICM serial numbers on the form. You can find these numbers on the Support page of the TracPhone V3-IP web interface or in the System Info LCD menu on the ICM's front panel. See "Equipment ID Numbers" on page 131.*

Fax or email the completed form(s) to KVH:

**Fax:** +1 401 851-3823

**Email:** [satelliteservices@kvh.com](mailto:satelliteservices@kvh.com)

Once KVH processes the form(s), activates your account, and registers your product, you will receive an email with the details of your new service, including your vessel's phone number(s).

### Contacting the Satellite Airtime and Product Activation Department

If you have any questions, or would like to make a change to your account, please contact KVH's Satellite Airtime & Product Activation Department via email at [satelliteservices@kvh.com](mailto:satelliteservices@kvh.com) or by phone at:

Region	Phone Number
Europe & Middle East	+45 45 160 197
North & South America	+1 401.847.3327
Asia	+65 31584084
U.S. & Canada	866.399.8509 (toll-free)

## Turning On the System

To turn on your TracPhone system, follow these steps:



### CAUTION

The antenna transmits RF energy that is potentially harmful. Make sure everyone stays more than 32 feet (10 m) away from the antenna while it is in use. No hazard exists directly above the antenna and anywhere below its mounting plane.

1. Make sure the antenna has a clear, unobstructed view of the sky.
2. Make sure vessel AC power is applied to the ICM and your computer(s).
3. Press the power button on the front of the ICM. The button's light should illuminate green.

Figure 2-1 Power Button

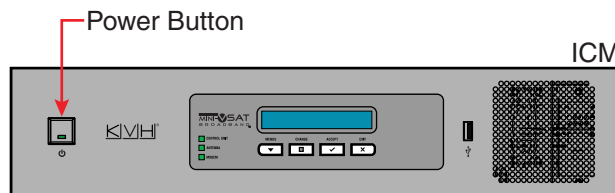

4. Wait at least five minutes for system startup. **Do not turn off the ICM during this time.**
5. Turn on your computer(s) that are connected to the network. Once the antenna finds the service satellite and the ICM's modem logs into the mini-VSAT Broadband service, all status lights on the ICM should be lit green. If any lights are not lit green, refer to ["LED Indicators"](#) on page 127.

## System Startup

The ICM shows the following screens during startup. Similar messages will also appear on the web interface. If the display shows an error message, see [“Error and Warning Messages”](#) on page 113.

ICM Screen	Description
ICM INITIALIZING...59	The system is running a self test routine
NO-TRANSMIT ZONE 1 AZ RANGE: 335-025	Displays the azimuth ranges of any user-configured no-transmit zones
ANTENNA READY WAITING FOR MODEM	The antenna is waiting for the ICM's modem to initialize
WAITING FOR GPS	The antenna is waiting for a GPS fix
GPS: ACQUIRED 41.5198N, 123.5817W	When GPS acquires a fix, momentarily displays your latitude/longitude
MODEM COMMS: OK	The ICM's modem is communicating OK
RECEIVING SATELLITE INFO FROM MODEM	The ICM's modem is providing satellite identification data to the antenna
ANTENNA STATE INITIALIZING	The antenna is initializing
SEARCHING FOR 105.0W SATELLITE	The antenna is searching for the mini-VSAT Broadband satellite
RF RADIATION HAZARD! TRANSMIT INHIBITED	If the antenna is pointing within an enabled no-transmit zone, it will not transmit
OFFLINE TRACKING 105.0W	The antenna is now tracking the satellite
ONLINE TRACKING 105.0W	The ICM's modem has accessed the mini-VSAT Broadband service; the system is ready for use!

## Accessing the Web Interface

The ICM offers a local web interface, which you can use to check system status, update software, and configure all aspects of the system. To access the web interface, simply open a web browser window on any computer on the network and enter the following web address:

**http://minivsat.kvh**

*NOTE: This web address may not work on all platforms and browsers. It also will not work in certain network configurations. If the web interface does not appear, enter the ICM's IP address instead (default is 192.168.5.1). You can find this address on the ICM front panel LCD (go to Settings > Network Settings > IP Assignments).*

As long as the ICM is turned on and functioning properly, the Home page will appear in your browser.

Figure 2-2 Web Interface Home Page

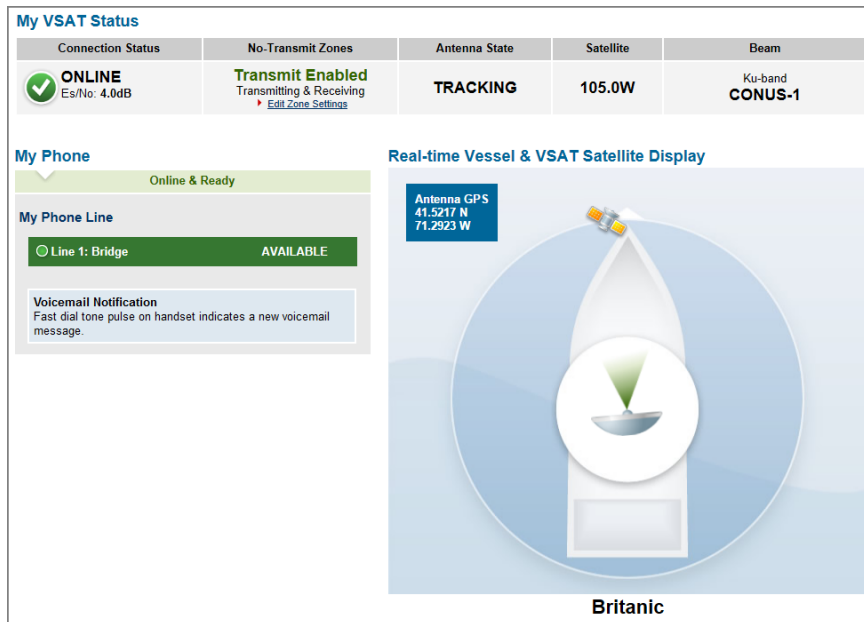

## Understanding the Home Page

The Home page of the TracPhone V3-IP web interface provides essential system status information, including the status of the antenna, the system's connection to the mini-VSAT Broadband service, and the voice service connection. It also displays the vessel's GPS position and provides a graphical representation of the antenna's pointing direction relative to the bow of the vessel.

Figure 2-3 Real-time Vessel & VSAT Satellite Display

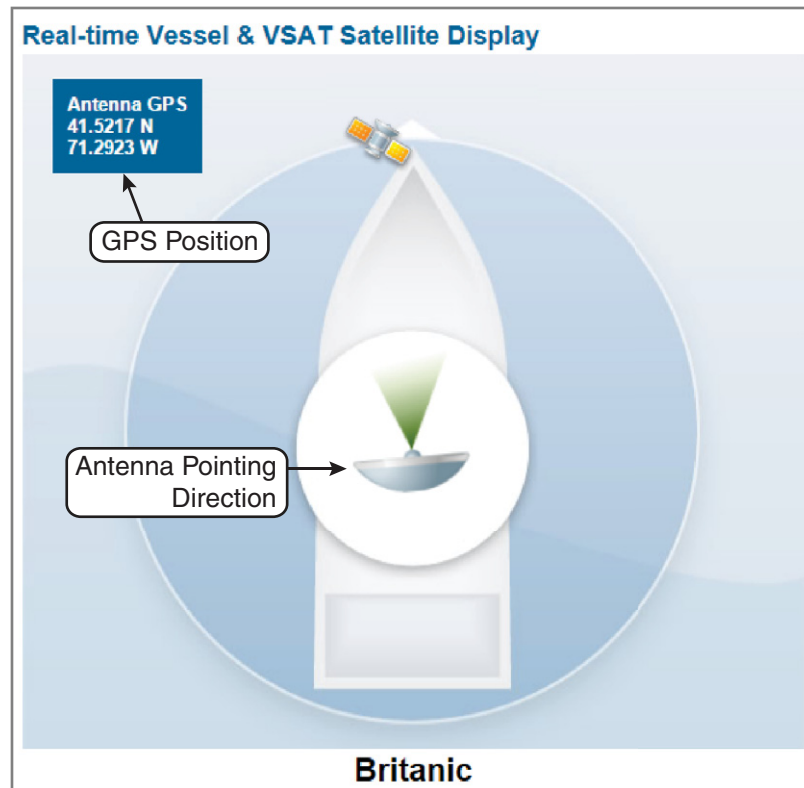



## Accessing the myKVH Web Portal

The myKVH secure web portal allows you to manage your vessel's mini-VSAT Broadband usage from anywhere over the Internet. Specifically, myKVH provides the following services:

- View vessel connection status, location, and data usage
- Set up data usage and overage alerts via email and/or SMS text message (see ["Setting Up Data Usage Alerts"](#) on page 89)
- Establish daily, weekly, or monthly data allocations for each user on the vessel
- Change the ICM's network configuration and Wi-Fi settings (see ["Selecting a Network Configuration"](#) on page 61)

*NOTE: If you manage a fleet of vessels, you can view and configure each vessel in your fleet.*

To access myKVH, open a web browser on any computer connected to the Internet and enter the following web address:

<http://www.mykvh.com>

At the login page, enter your email address and the password provided to you by KVH's Satellite Airtime and Product Activation Department.

Figure 2-4 myKVH Web Portal (Example)

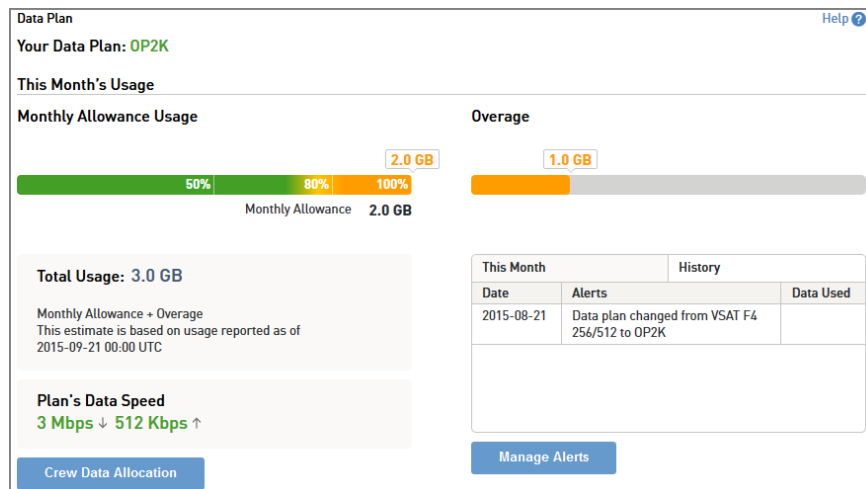

## Viewing the Help (User Documentation)

The system's Help is available on the Support page of the TracPhone V3-IP web interface. Two options are offered: Condensed and Extended. Refer to either of these resources for answers to your operation, configuration, or troubleshooting questions.

---

### Important!

You might need to clear your web browser's cache in order to view the latest version of the Help. See ["Clearing the Cache of Your Web Browser" on page 22](#) for details.

---

*NOTE: The Help is compatible with the following web browsers: Internet Explorer, Mozilla Firefox, Google Chrome, and Apple Safari. If you are using Internet Explorer version 10, you will first need to adjust the width of the Help's navigation pane to view topics due to a known software issue.*

### Condensed Help

- Resides on the ICM locally
- Text-only format

### Extended Help

- Resides on the KVH website (airtime charges may apply)
- Media-rich format, complete with images and tutorials

To access either of these resources from the ICM, follow these steps:

1. At the TracPhone V3-IP web interface, click the **Support** tab.
2. On the **Help** menu, click the desired option.

Figure 2-5 Help Options

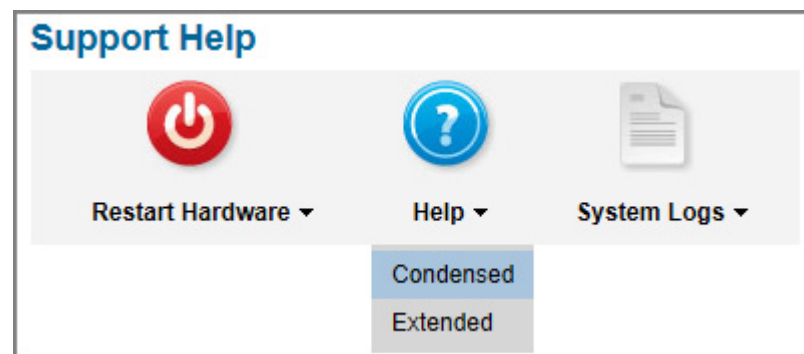

## Clearing the Cache of Your Web Browser

When you visit a web page, your browser may store a copy of it in its local cache. As a result, when you revisit the page, the browser may display the old copy it had previously stored rather than reload the latest version from the web. Since the Help actually consists of a set of web pages, you might need to clear your web browser's cache to force it to load the latest version. For example, in Internet Explorer, go to Tools > Safety > Delete Browsing History (or press Ctrl + Shift + Del), select **Temporary Internet files**, then click **Delete**.

Figure 2-6 Clearing the Cache in Internet Explorer

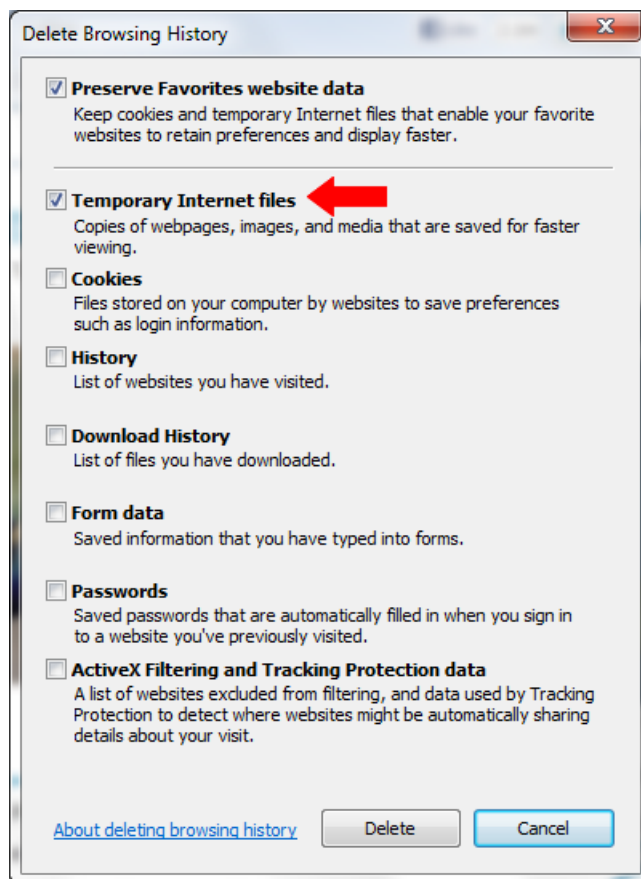



# 3. Interface Preferences

This section explains how to customize the TracPhone V3-IP web interface by entering the names of the vessel and phone line. It also explains how to change the Administrator password and adjust the brightness of the ICM's front panel LCD.

## Contents

Changing the Administrator Password .....	25
Entering the Vessel Name .....	26
Assigning the Phone Line Name.....	27
Adjusting the LCD Brightness .....	28



## Changing the Administrator Password

You must be logged in as an Administrator to make any substantial changes to the system's configuration on the TracPhone V3-IP web interface. To prevent unauthorized user access, KVH recommends that you change the Administrator password to something unique.

To change the Administrator password, follow these steps:

1. At the TracPhone V3-IP web interface, click the **Settings** tab. Then click **Account**.
2. In Security, click **Edit**.
3. Enter the current password. If the password has never been changed, enter the default password: "**password**".

*NOTE: The password must be between 4 and 20 characters in length, with at least one letter and one number, case-sensitive.*

4. Enter and then re-enter your new password.
5. Click **Save Settings**.

Figure 3-1 Changing the Administrator Password

Security	
Change the administrator's login password.	
Enter the current password:	<input type="password"/>
Enter the new password:	<input type="password"/> <span style="color: green;">✔ Strong</span> <small>(between 4 and 20 characters long, with at least one letter and one number, case sensitive)</small>
Re-enter the new password:	<input type="password"/>
<input type="button" value="Cancel"/> <input type="button" value="Save Settings"/>	

## Entering the Vessel Name

The vessel name is displayed on the Home page of the TracPhone V3-IP web interface. It also appears in all technical support communications.

To enter your vessel's name in the TracPhone V3-IP web interface, follow these steps:

1. At the TracPhone V3-IP web interface, click the **Settings** tab. Then click **Account**.
2. In Vessel Name, click **Edit**.
3. If the Login window appears, log in with the Administrator password.
4. Enter your vessel's name.
5. Click **Save Settings**.

Figure 3-2 Entering the Vessel Name

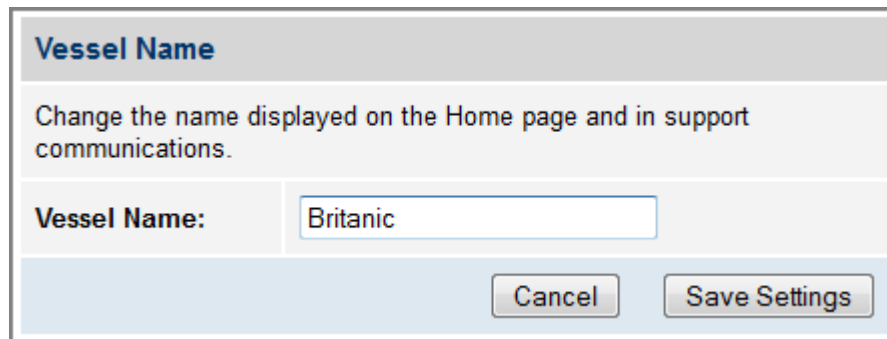

The screenshot shows a web form titled "Vessel Name". Below the title is a descriptive text: "Change the name displayed on the Home page and in support communications." There is a text input field labeled "Vessel Name:" containing the text "Britanic". At the bottom right of the form are two buttons: "Cancel" and "Save Settings".

## Assigning the Phone Line Name

The phone line name is displayed on the Home page of the TracPhone V3-IP web interface. It also appears in all technical support communications. For example, you might assign the name "Bridge."

To assign a name to the phone line, follow these steps:

1. At the TracPhone V3-IP web interface, click the **Settings** tab. Then click **Other**.
2. In Phone Line Name, click **Edit**.
3. If the Login window appears, log in with the Administrator password.
4. Enter a name for Line 1.
5. Click **Save**.

Figure 3-3 Assigning the Phone Line Name

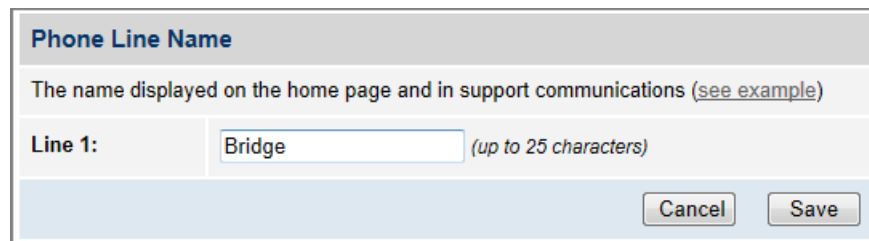

The screenshot shows a web form titled "Phone Line Name". Below the title is a descriptive text: "The name displayed on the home page and in support communications (see example)". There is a label "Line 1:" followed by a text input field containing the word "Bridge". To the right of the input field is a note "(up to 25 characters)". At the bottom right of the form are two buttons: "Cancel" and "Save".

## Adjusting the LCD Brightness

You can adjust the brightness of the ICM's front panel LCD to suit your preferences.

To adjust the brightness of the ICM's display, follow these steps:

1. At the ICM front panel, press **MENUS** until the display shows "SETTINGS."
2. Press **ACCEPT**.
3. At "SYSTEM SETTINGS," press **ACCEPT**.
4. At "LCD BRIGHTNESS," press **ACCEPT**.
5. Press **MENUS** until the display shows the desired brightness setting: HIGH, MEDIUM, or LOW.
6. Press **ACCEPT**.
7. Press **EXIT** to exit the menu.

Figure 3-4 LCD Brightness Setting

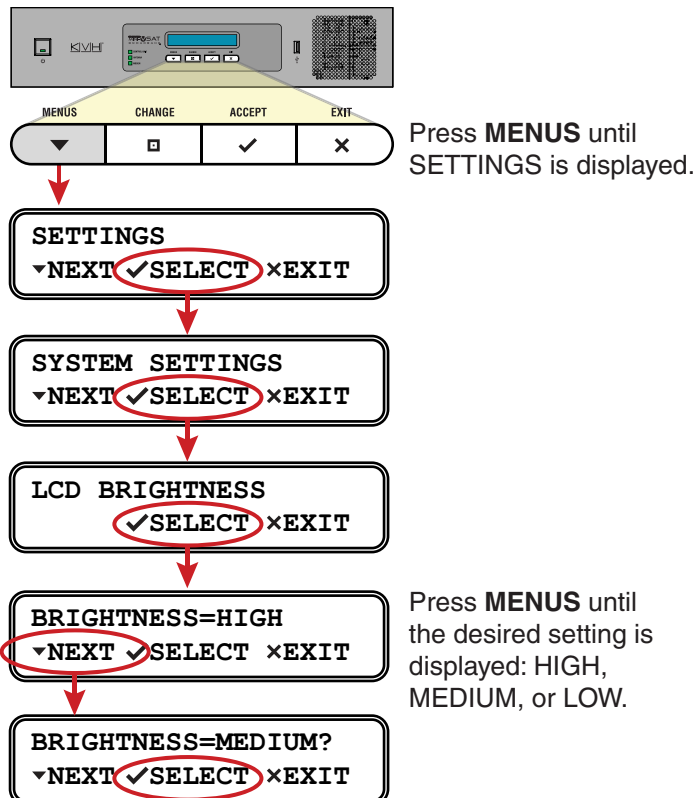





# 4. No-Transmit Zones

This section explains how to view, configure, temporarily disable, and clear no-transmit zones, which prohibit the antenna from transmitting within a certain azimuth range.

## Contents

No-Transmit Zones Overview .....	31
Status of No-Transmit Zones.....	32
Establishing No-Transmit Zones.....	33
Disabling No-Transmit Zones .....	35
Clearing No-Transmit Zones.....	36



## No-Transmit Zones Overview

To prevent exposure to the antenna's radiated RF (radio frequency) energy, you can configure up to two no-transmit zones for areas where crew and passengers frequent. Whenever the antenna points within a no-transmit zone, the system disables the transmitter. Transmission capability is restored whenever the antenna points outside the zone.

*NOTE: See "RF Radiation Hazard Area" on page 6 for details on the minimum safety distances.*

Figure 4-1 Example of a No-Transmit Zone

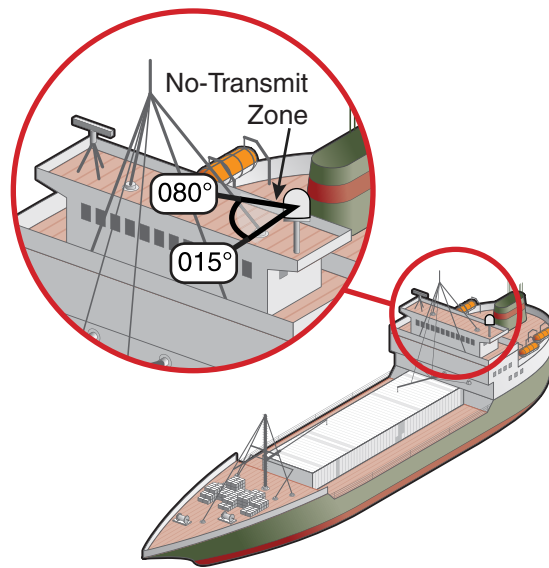

## Status of No-Transmit Zones

You can view the current status of the system's no-transmit zones on the Home page of the TracPhone V3-IP web interface. If no-transmit zones have been set up, "My VSAT Status" includes a No-Transmit Zones column. If this column is missing, no transmit zones have not yet been set up or they have been cleared from memory. See ["Establishing No-Transmit Zones" on page 33](#) for details on setting up no-transmit zones.

Figure 4-2 No-Transmit Zones Status Information on Home Page

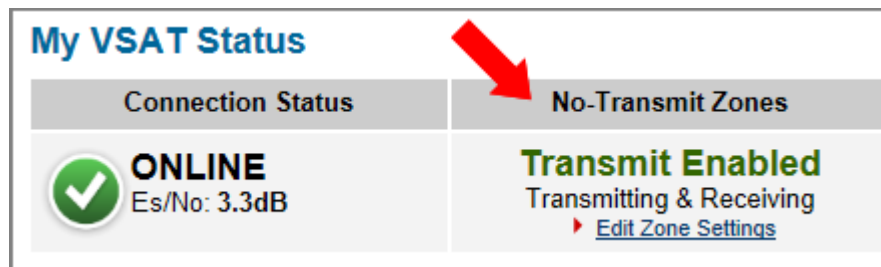

The No-Transmit Zones column will display one of the following status indications:

- **Transmit Enabled (green)** – One or two no-transmit zones have been set up and are currently enforced. However, the antenna is not pointing within a no-transmit zone.
- **Transmit Disabled (orange)** – One or two no-transmit zones have been set up and are currently enforced. The antenna is pointing within a no-transmit zone and will not transmit.
- **Transmit Enabled (red)** – One or two no-transmit zones have been set up, but they are currently being ignored (see ["Disabling No-Transmit Zones" on page 35](#)). The antenna can transmit in any direction without restriction.

*NOTE: You can also view the status of no-transmit zones on the ICM's front panel LCD (go to No-Transmit Zones).*

## Establishing No-Transmit Zones

To configure a no-transmit zone, follow these steps:

1. Identify the necessary azimuth range for the zone (see [“Identify the Azimuth Range”](#)).
2. At the TracPhone V3-IP web interface, configure a no-transmit zone for that azimuth range (see [“Configure the No-Transmit Zone\(s\) at the Web Interface”](#) on page 34).

### Identify the Azimuth Range

First, you need to determine the necessary azimuth range for the no-transmit zone(s). You will need to enter, in clockwise order, the beginning and ending azimuths that define the outer boundaries of the zone, **relative to the antenna's forward arrow**, which should be pointing toward the bow.

*NOTE: Each no-transmit zone must span at least 5°. Therefore, be sure to set beginning and ending azimuths at least 5° apart.*

Figure 4-3 Beginning and Ending Azimuths Defining a No-Transmit Zone (Example)

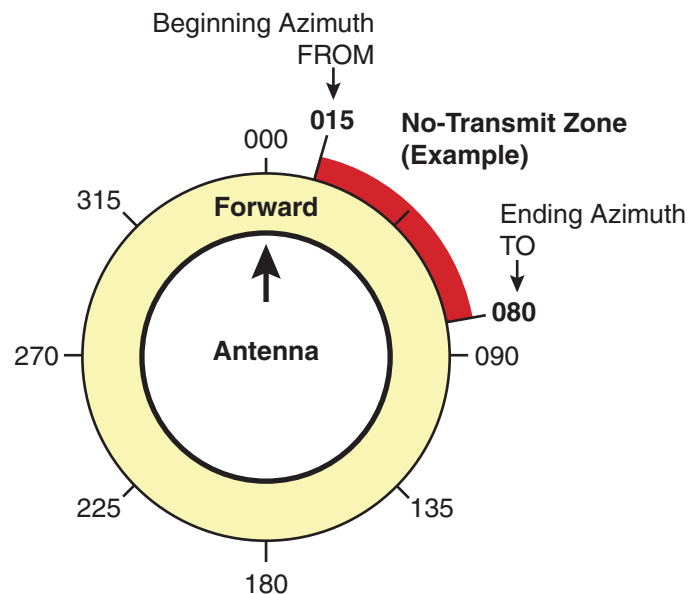

### Configure the No-Transmit Zone(s) at the Web Interface

1. At the TracPhone V3-IP web interface, click the **Settings** tab. Then click **No-Transmit Zones**.
2. Click **Edit**.
3. If the Login window appears, log in with the Administrator password.
4. In No-Transmit Zone Ranges, make sure **Enforce Zones** is selected.

---

### Important!

When “Enforce Zones” is selected, the antenna will not transmit whenever it points within one of your configured no-transmit zones. If “Ignore Zones” is selected instead, the zones are disabled, allowing the antenna to transmit in any direction without restriction.

---

5. Enter the azimuth range for Zone 1.
6. If you wish to set up a second no-transmit zone, enter the azimuth range for Zone 2.
7. Click **Save All Settings**.
8. At the confirmation message, click **Save**.

Figure 4-4 Configuring No-Transmit Zones

**No-Transmit Zone Ranges:**

**Enforce Zones**  
*The antenna will not transmit within the zone(s) specified below.*

**Ignore Zones**  
*The antenna will be able to transmit in any direction without restriction. Be sure everyone stays the minimum safe distance away from the antenna.*

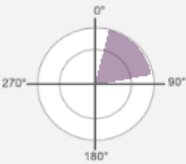
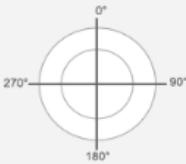
Zone 1	Zone 2
<b>Azimuth Range</b> From: <input type="text" value="15"/> ° To: <input type="text" value="80"/> ° 	<b>Azimuth Range</b> From: <input type="text" value="---"/> ° To: <input type="text" value="---"/> ° 
<i>Select Enforce Zones first. Zone must span more than 5°.</i>	<i>Select Enforce Zones first. Zone must span more than 5°.</i>

## Disabling No-Transmit Zones

You can disable your programmed no-transmit zones to temporarily remove all restrictions on transmissions. This function permits the antenna to ignore the zones; it does not delete them from the system's memory.



### CAUTION

Disabling no-transmit zones allows the antenna to transmit in any direction, even if the antenna is pointing in an area accessible to passengers and crew. Make sure everyone stays the minimum safe distance away from the antenna while it is in use (see [“RF Radiation Hazard Area”](#) on page 6).

To disable the no-transmit zones, follow these steps:

1. At the TracPhone V3-IP web interface, click the **Settings** tab. Then click **No-Transmit Zones**.
2. Click **Edit**.
3. If the Login window appears, log in with the Administrator password.
4. In No-Transmit Zone Ranges, click **Ignore Zones**.
5. Click **Save All Settings**.
6. At the confirmation message, click **Ignore Zones**.

Figure 4-5 Disabling No-Transmit Zones

**No-Transmit Zone Ranges:**

**Enforce Zones**  
*The antenna will not transmit within the zone(s) specified below.*

**Ignore Zones**  
*The antenna will be able to transmit in any direction without restriction. Be sure everyone stays the minimum safe distance away from the antenna.*

## Clearing No-Transmit Zones

You can clear all no-transmit zones from the system's memory. Unlike disabling zones, clearing zones permanently deletes them.



### CAUTION

Clearing no-transmit zones allows the antenna to transmit in any direction without restriction. Make sure everyone stays the minimum safe distance away from the antenna while it is in use (see ["RF Radiation Hazard Area"](#) on page 6).

*NOTE: This procedure explains how to clear no-transmit zones using the TracPhone V3-IP web interface. If you prefer, you may use the front panel LCD menu instead (go to Diagnostic Tools > Factory Reset).*

To clear the no-transmit zones, follow these steps:

1. At the TracPhone V3-IP web interface, click the **Settings** tab. Then click **No-Transmit Zones**.
2. Click **Edit**.
3. If the Login window appears, log in with the Administrator password.
4. In No-Transmit Zone Ranges, click **Clear All Zones**.
5. At the confirmation message, click **Clear Zones**.

Figure 4-6 Clearing No-Transmit Zones

**No-Transmit Zone Ranges:**

**Enforce Zones**  
*The antenna will not transmit within the zone(s) specified below.*

**Ignore Zones**  
*The antenna will be able to transmit in any direction without restriction. Be sure everyone stays the minimum safe distance away from the antenna.*

Zone 1	Zone 2
<b>Azimuth Range</b> From: 15 ° To: 80 ° 	<b>Azimuth Range</b> From: --- ° To: --- ° 

Select Enforce Zones first. Zone must span more than 5°.

Select Enforce Zones first. Zone must span more than 5°.

Cancel Clear All Zones Save All Settings



# 5. Tracking Avoidance Zones

This section explains how to configure, temporarily disable, and clear tracking avoidance zones, which trigger the antenna to switch to another satellite when tracking in a marginal reception area.

## Contents

Tracking Avoidance Zones Overview.....	39
Setting Up Tracking Avoidance Zones.....	40
Disabling Tracking Avoidance Zones.....	45
Clearing Tracking Avoidance Zones .....	46





## Tracking Avoidance Zones Overview

In an ideal installation, the antenna has a clear view of the sky in all directions and no other radiating equipment is nearby that can interfere with the satellite signal. However, such an ideal installation is not always achievable on a vessel, particularly on smaller yachts. Therefore, the system allows you to configure up to five tracking avoidance zones for areas where there may be partial blockage or RF interference causing marginal reception and intermittent antenna performance.

Whenever the antenna is tracking a satellite in the direction of a tracking avoidance zone, it will switch to a different satellite if one is available. An **allowance period** (1-60 minutes, selectable) precludes switching in cases when the antenna is simply passing through a zone while the vessel is turning. The system calculates how long the antenna will be pointing in the zone based on the vessel's rate of turn. If the calculated time exceeds the allowance period, the antenna will immediately switch satellites, as long as there is an alternate satellite available in your service region.

Figure 5-1 Passing Through a Tracking Avoidance Zone (Example)

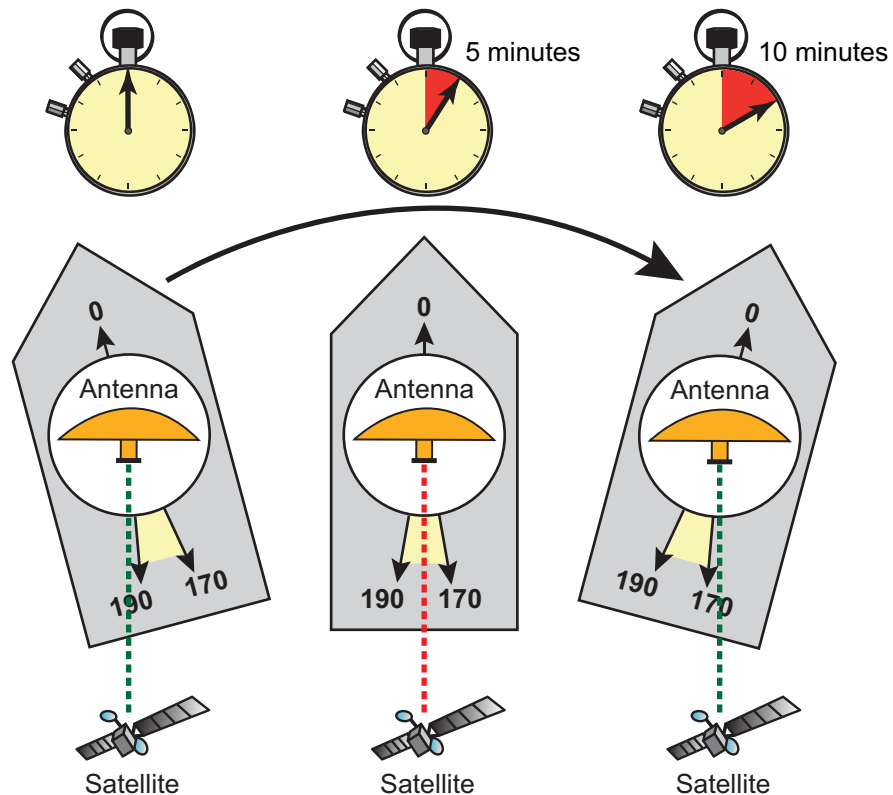

Tracking Avoidance Zone = 170° to 190° (azimuth)  
 Rate of Turn = 2° per minute

## Setting Up Tracking Avoidance Zones

To configure a tracking avoidance zone, follow these steps:

1. Identify the necessary azimuth range for the zone (see [“Identify the Azimuth Range”](#)).
2. Identify the necessary elevation range for the zone (see [“Identify the Elevation Range”](#) on page 41).
3. At the TracPhone V3-IP web interface, configure a tracking avoidance zone for that combination of azimuth and elevation ranges (see [“Configure the Tracking Avoidance Zone\(s\) at the Web Interface”](#) on page 42).

### Identify the Azimuth Range

First, you need to determine the necessary azimuth range for the tracking avoidance zone(s). You will need to enter, in clockwise order, the beginning and ending azimuths that define the outer boundaries of the zone, **relative to the antenna’s forward arrow**, which should be pointing toward the bow.

*NOTE: Each tracking avoidance zone must span at least 5°. Therefore, be sure to set beginning and ending azimuths at least 5° apart.*

Figure 5-2 Beginning and Ending Azimuths Defining a Zone (Example)

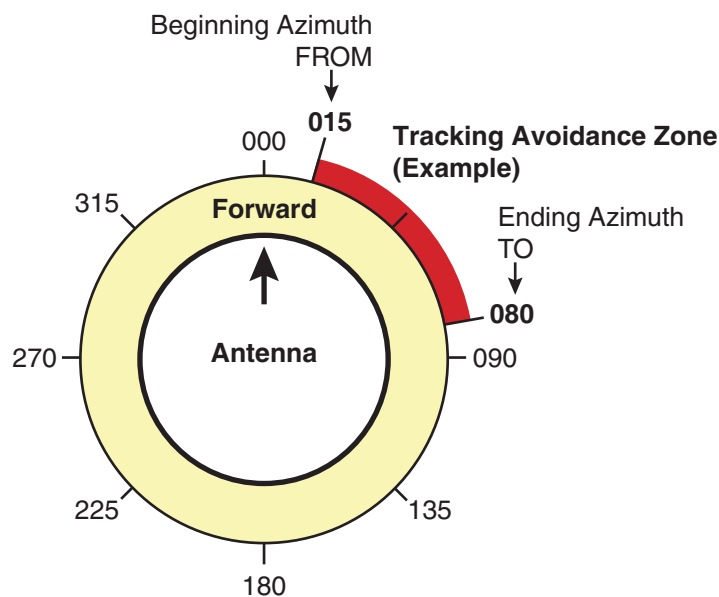

### Identify the Elevation Range

Now you need to determine the necessary elevation range for the tracking avoidance zone(s). You will need to enter, in ascending order, the beginning and ending elevations that define the outer boundaries of the zone.

*NOTE: Each tracking avoidance zone must span at least 5°. Therefore, be sure to set beginning and ending elevations at least 5° apart.*

*NOTE: Although you may enter an elevation as low as -25° and as high as 90°, the TracVision V3-IP antenna can only receive satellite signals within its 7.5° to 75° operating range.*

Figure 5-3 Beginning and Ending Elevations Defining a Zone (Example)

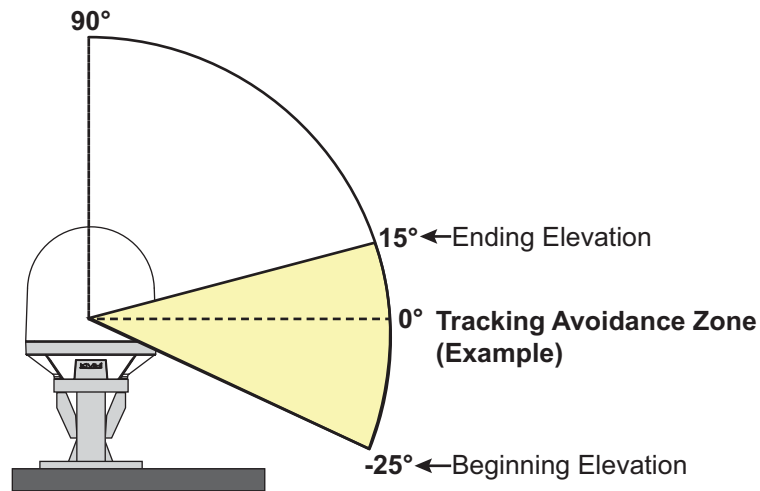

### **Configure the Tracking Avoidance Zone(s) at the Web Interface**

1. At the TracPhone V3-IP web interface, click the **Settings** tab. Then click **Tracking Avoidance Zones**.
2. Click **Edit**.
3. If the Login window appears, log in with the Administrator password.
4. Enter the azimuth and elevation ranges for Zone 1. Then select the **Enabled** check box.
5. If you wish to set up another tracking avoidance zone, select a zone from the drop-down menu and repeat step 4 for the selected zone.
6. In the Time in Zone box, enter the maximum number of minutes (between 1 and 60) during which the antenna will be allowed to track within a tracking avoidance zone (see ["Tracking Avoidance Zones Overview"](#) on page 39 for details).
7. Click **Save Settings**.
8. At the confirmation message, click **Save**.

Figure 5-4 Configuring Tracking Avoidance Zones

### Tracking Avoidance Zone Ranges:

**MIN**      **Time In Zone**  
*Maximum number of minutes (1-60) the antenna will be allowed to track within the zone(s) specified below*

**Choose a Zone:**

Zone 1

---

**Zone 1**      **Enabled**

**Azimuth Range:**  
*Must span at least 5°*

From:  °  
To:  °

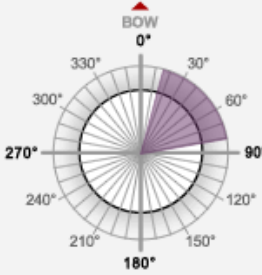

**Elevation Range:**  
*Must span at least 5°*

From:  °  
To:  °

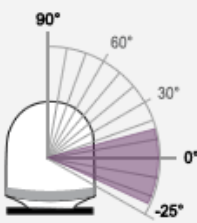

### Understanding the Cumulative View

The Tracking Avoidance Zones page displays a diagram that indicates the cumulative azimuth and elevation ranges of the tracking avoidance zones that are currently enabled. The circumference of the circle indicates azimuth, while the radius indicates elevation. In the example shown here, the following tracking avoidance zones are enabled:

- Zone 1 (purple) = Azimuth: 170° to 190°, Elevation: -25° to 20°
- Zone 2 (blue) = Azimuth: 15° to 55°, Elevation: 30° to 90°

Figure 5-5 Cumulative View of All Enabled Tracking Avoidance Zones

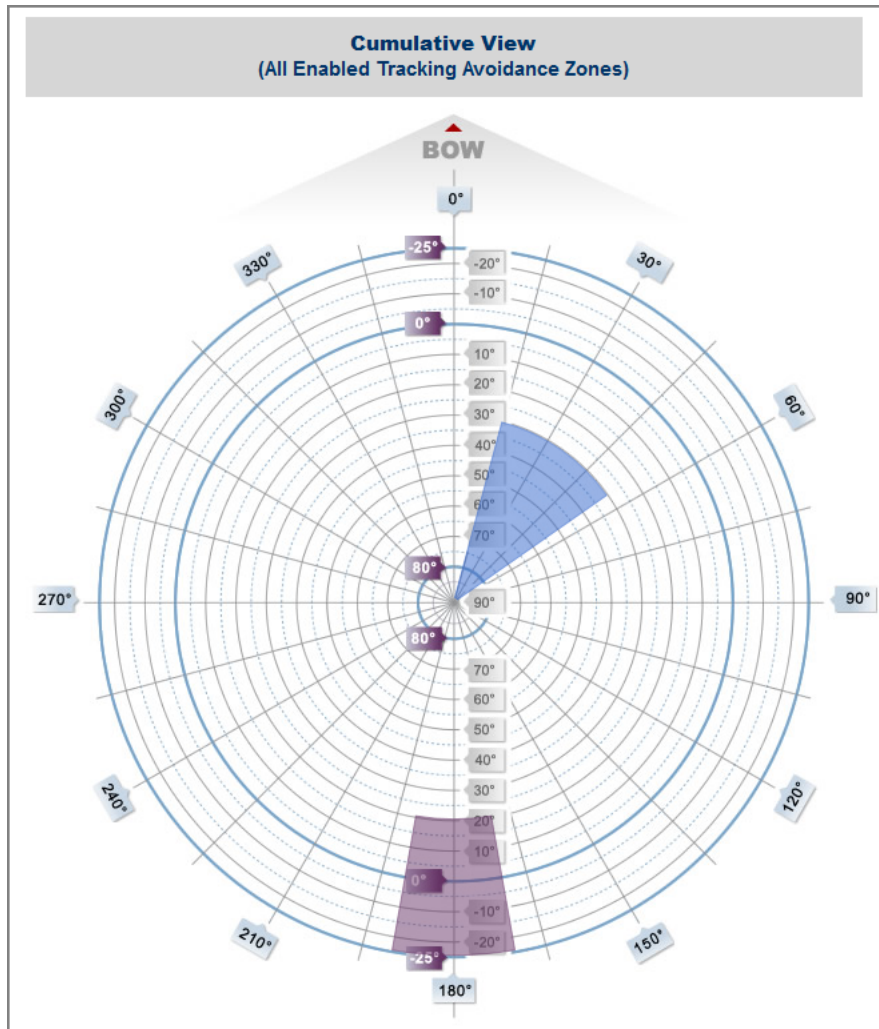

## Disabling Tracking Avoidance Zones

You can disable any of your programmed tracking avoidance zones to temporarily remove its restrictions on tracking. This function permits the antenna to ignore the zone(s); it does not delete them from the system's memory.

To disable a tracking avoidance zone, follow these steps:

1. At the TracPhone V3-IP web interface, click the **Settings** tab. Then click **Tracking Avoidance Zones**.
2. Click **Edit**.
3. If the Login window appears, log in with the Administrator password.
4. Select the zone you want to disable from the drop-down menu.
5. Clear the **Enabled** check box. The zone disappears from the Cumulative View.
6. Click **Save Settings**.
7. At the confirmation message, click **Save**.

Figure 5-6 Disabling Tracking Avoidance Zones

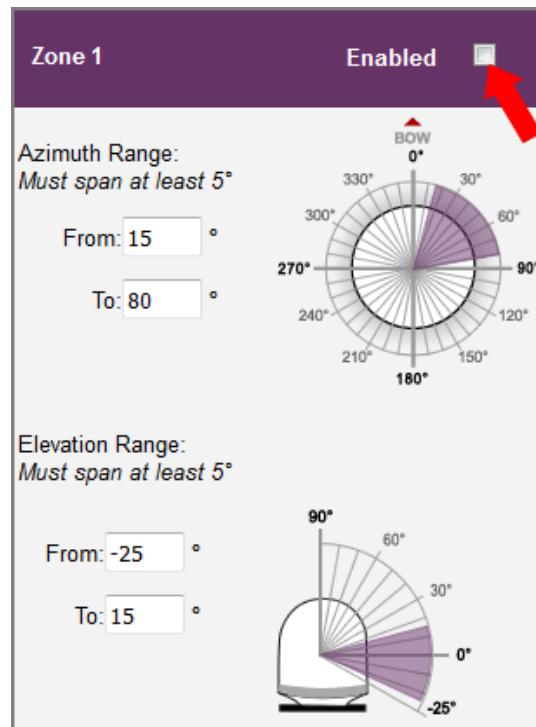

## Clearing Tracking Avoidance Zones

You can clear all tracking avoidance zones from the system's memory. Unlike disabling zones, clearing zones permanently deletes them.

To clear the tracking avoidance zones, follow these steps:

1. At the TracPhone V3-IP web interface, click the **Settings** tab. Then click **Tracking Avoidance Zones**.
2. Click **Edit**.
3. If the Login window appears, log in with the Administrator password.
4. Click **Clear Zones**.
5. At the confirmation message, click **Clear Zones**.

Figure 5-7 Clearing Tracking Avoidance Zones

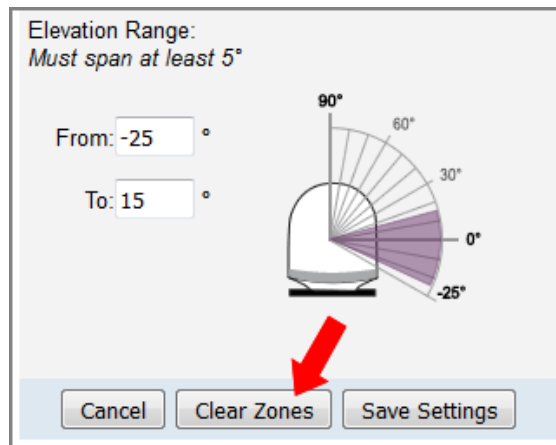





# 6. Voice Connections

This section covers everything you need to know about the enhanced voice service. It explains how to place calls, add virtual numbers, check VoiceMail, send a fax, and access your voice account online.

## Contents

Voice Service Overview .....	49
Making a Ship-to-Shore Call .....	50
Making a Shore-to-Ship Call .....	52
Virtual Numbers.....	53
VoiceMail .....	54
Faxing.....	56
Accessing Your Voice Account .....	58



## Voice Service Overview

KVH's enhanced voice service – Voice over IP (VoIP) optimized for satellite communications – allows you to make and receive phone calls via the TracPhone system and the mini-VSAT Broadband service. Voice traffic is given priority on the network over standard Internet data to ensure the highest quality voice connections at all times.

### Important!

The TracPhone V3-IP voice service will not provide Automatic Number Identification or Automatic Location Information capabilities associated with emergency services, such as 911 or E911. In addition, the voice service will not work in the event of either a network service outage or a power failure. Therefore, it is critical that you maintain your vessel's separate distress and safety communications system for emergency calls. Be sure to inform anyone who may use the TracPhone V3-IP of the limitations of emergency services. *The manufacturer, distributor, and service provider shall not be liable for, and expressly disclaim, any direct or indirect damages, claims, losses, expenses, liabilities, actions, risks, or harms arising out of or related to the services provided through this equipment, including without limitation, emergency services.*

## How the Voice Service Works

When you dial a phone number using the ship's analog phone, the TracPhone system converts its analog signal into digital VoIP data and transmits it over the mini-VSAT Broadband network to an Internet-based SIP (session initiation protocol) server. The digital VoIP data is then converted back into its original analog signal and routed via a proxy server to the appropriate public switched telephone network (PSTN). Finally, the telephone network's carrier completes the call to ring the desired shore phone line.

Figure 6-1 Voice Service Call Routing

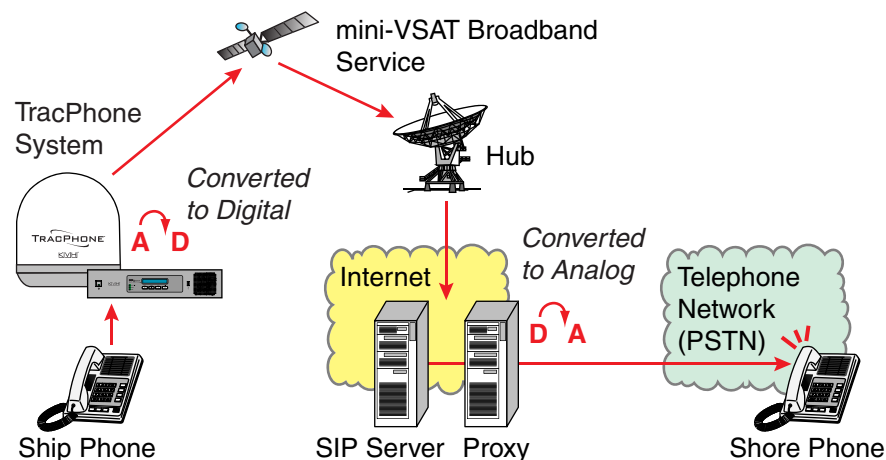

## Making a Ship-to-Shore Call

To place a call from the vessel, follow these steps:

1. Make sure the TracPhone system is online.
2. Pick up the handset on any phone connected to the ICM. You should hear a dial tone. If you don't, check the phone line status on the web interface's Home tab.
3. Dial the phone number you wish to call. The dialing sequence you use depends on the vessel's Line 1 phone number.

### Dialing a Number Outside the Country Assigned to Line 1

Dial the number as an international call:

<**International prefix**, as originating from your Line 1 country>  
+ <**country code**>  
+ <**area/city code**>  
+ <**local phone number**>

### Dialing a Number Within the Country Assigned to Line 1

Dial the number as an in-country call:

<**area/city code**>  
+ <**local phone number**>

### Dialing a Number Within the Country & Area Code Assigned to Line 1

Dial the number as a local call:

<**local phone number**>

*NOTE: When you place a call, your voice travels to a satellite in space then back to Earth. This transit will cause a brief delay (approximately 1/2 second) in your conversation.*

Figure 6-2 Ship-to-Shore Calls (Example)

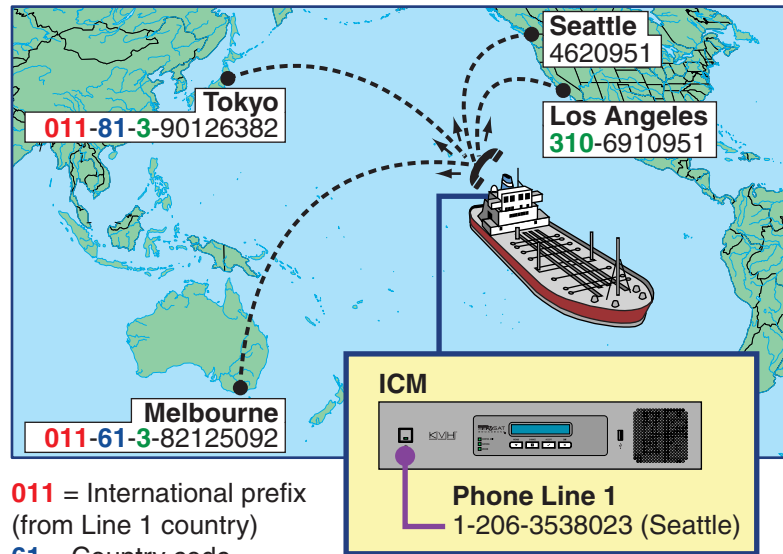

**011** = International prefix  
(from Line 1 country)  
**61** = Country code  
**3** = Area/City code  
82125092 = Local phone no.

On a metered rate plan, incoming and outgoing calls are charged one flat rate per minute. For details, refer to the rate sheet available online at [www.kvh.com/mvbcustomercenter](http://www.kvh.com/mvbcustomercenter).

## Making a Shore-to-Ship Call

People on shore call your vessel by dialing your vessel's phone number. They are billed international and long-distance charges based on the vessel's phone number, and not on the location of the vessel. Therefore, when you set up your phone number during service activation, it is advisable to select the same country code and area/city code you use at home (an additional monthly fee will apply). This will allow family, friends, and business associates in your home region to call your vessel as an in-country call.

*NOTE: If you wish to change your vessel's phone number, contact KVH's Satellite Airtime & Product Activation department. See "Contacting the Satellite Airtime and Product Activation Department" on page 15.*

In the example shown here, people in Los Angeles who call the vessel's U.S.-based phone number will not be charged international fees.

Figure 6-3 Shore-to-Ship Calls (Example)

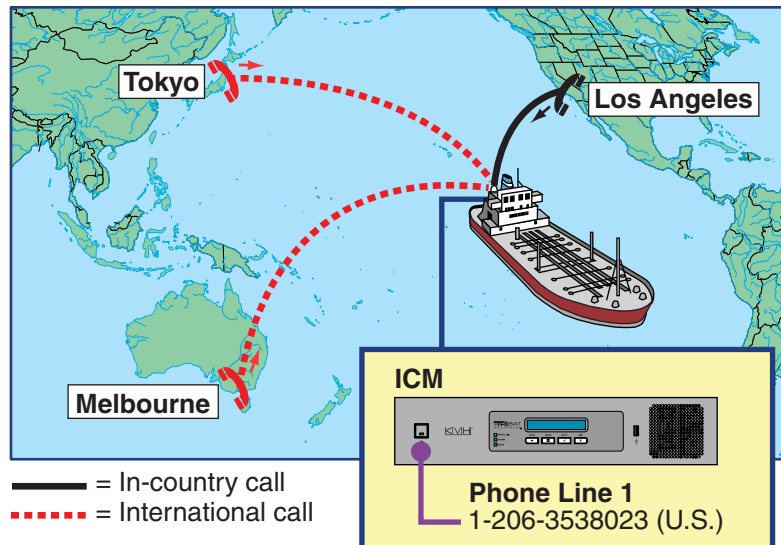

## Virtual Numbers

For an additional fee, you may assign up to five virtual phone numbers to the vessel phone line. Each of these numbers can be set up with a different country code and area/city code, allowing people on shore within those regions to avoid international or long-distance charges when they call the vessel.

To set up virtual numbers, contact KVH's Satellite Airtime & Product Activation department. See ["Contacting the Satellite Airtime and Product Activation Department"](#) on page 15.

In the example shown here, the vessel's company has offices in Tokyo and Melbourne. Therefore, they set up Japanese and Australian virtual numbers so that their employees on shore can call the vessel without running up an international phone bill.

Figure 6-4 Virtual Numbers (Example)

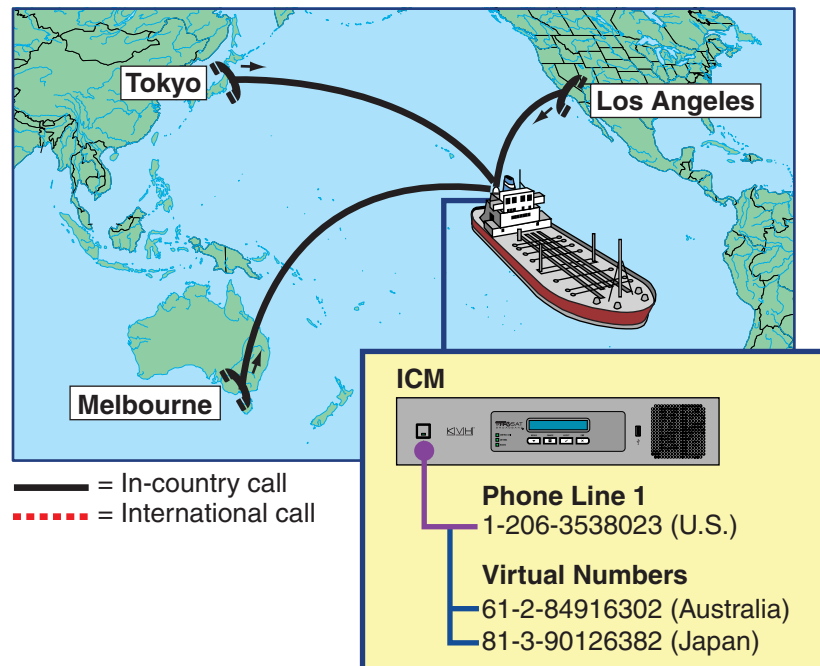

## VoiceMail

KVH's enhanced voice service offers a similar suite of features as you might find with any landline telephone service. One of these features is VoiceMail.

With VoiceMail, people who call the vessel may record a message if you are unable to answer the call or the line is busy. You can then play back and listen to your messages anytime (24/7) from anywhere, even if you are not currently onboard the vessel.

### Recording a VoiceMail Personal Greeting

To record your VoiceMail personal greeting, follow these steps:

1. Pick up the handset on any phone connected to the ICM. You should hear a dial tone.
2. Dial **123#** to connect to the VoiceMail system.
3. Press **2** to access your mailbox.
4. Press **1** to access your personal greeting.
5. Press **2** to change your greeting. You will be prompted to record your greeting.
6. Press **1** to listen to your personal greeting.
7. When you are satisfied with your greeting, press **3** to accept and activate your greeting. You will hear the message "Your personal greeting has been activated."

### Listening to Your VoiceMail Messages

If you hear a fast dial tone pulse in the phone's handset, you have new VoiceMail messages. To listen to your VoiceMail messages, follow these steps:

1. Dial **123#** to connect to the VoiceMail system.
2. Press **1** to listen to your messages.
3. Follow the spoken instructions to listen to, save, and/or delete your messages.



## Listening to Your Messages on Shore

You still have access to your VoiceMail messages when you disembark the vessel. Choose one of the following options:

- **Use a computer:** Go to your voice account web page (see ["Accessing Your Voice Account" on page 58](#)). Then click the **VoiceMail** button.
- **Use a regular landline telephone:** Dial the number for your vessel phone line (Line 1), press \*, then enter your PIN (provided during service activation).



## Faxing

You can fax documents via the enhanced voice service. Connect a fax machine to the "Voice Line 1" jack on the ICM and dial the fax number as you would a voice call (see ["Making a Ship-to-Shore Call" on page 50](#)).

*NOTE: Faxing requires 70 kbps bandwidth for sending and up to 90 kbps bandwidth for receiving.*

For extremely reliable faxing, KVH offers the UCH-250 fax server (see ["UCH-250 Fax Server" on page 57](#)). The UCH-250 avoids the industry-wide problem of dropped or incomplete faxes commonly associated with faxing over Voice over IP (VoIP) connections.

## UCH-250 Fax Server

Faxing over Internet Protocol can be unreliable at times (normally an 80% success rate). Glitches like latency, packet loss, and jitter, common with any VoIP connection, can interrupt the synchronization necessary for fax communications. KVH's optional UCH-250 Fax Server (KVH part no. 19-0520) overcomes these limitations by providing a dedicated fax line with the reliability of a fully managed, store-and-forward system. In addition to installing the fax server, you will need to activate the supplemental fax service. Contact your dealer/distributor for details.

Figure 6-5 UCH-250 Fax Server Connections

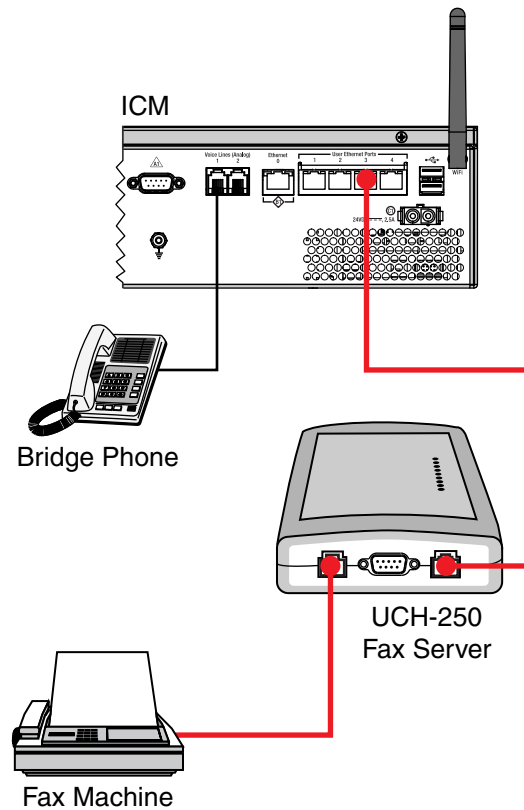

## Accessing Your Voice Account

You can manage your account online at KVH's Enhanced VoIP Service Account Center. You can view and configure all of the various calling features available to you, as well as view account information and listen to VoiceMails. To log onto the site, follow these steps:

1. Go to <http://kvh.myaccountcenter.net>.
2. At the login page, enter your Line 1 phone number and PIN, provided during service activation. Then click **Login**.

Figure 6-6 Enhanced VoIP Service Account Center

mini-VSAT Broadband  
Enhanced VoIP Service

KVH INDUSTRIES  
MINI-VSAT  
BROADBAND

Account Center ::

:: Enhanced VoIP Service Account Center Logout

**My Information**

Your Device ID: <b>00109911fd18</b> Phone Line(s): <a href="#">View all phone numbers</a> Line 1 - Phone Number: 14013674517 Your calling plan is: <b>us unlimited (no canada)</b> You have 0 new VoiceMail messages.	<b>Current Usage</b> Period: <b>14-Jul-2012 to 14-Aug-2012</b> Calling Plan Usage: Local & National(Unlimited) -- Unlimited
---	--

For information about using Enhanced VoIP Service visit our [Support](#) section.  
For Billing/Activation questions, please contact 1-866-399-8509.  
For Tech Support for the TracPhone V7, please contact us at 1-401-847-3327.

Call History Find Rates VoiceMail Manage Features

**Test your Internet connection speed:**  
The speed of your Internet connection determines the voice quality of your calls.  
Use the free online speed test at [www.voipreview.org](http://www.voipreview.org).

**Finished with Enhanced VoIP Service Account Center:**  
Please [Logout](#).

[www.kvh.com](http://www.kvh.com) Your Account Home Technical Support

You've chosen TracPhone for marine satellite communications, now choose TracVision for your onboard entertainment needs.  
:: Visit [www.tracvision.com](http://www.tracvision.com) today.

# 7. Network Configuration

This section explains the various network configuration options for connecting your vessel's computers and other network devices to the TracPhone system. It also provides an overview of the advanced network settings that are available.

## Contents

Selecting a Network Configuration.....	61
Standard Configuration.....	64
Static IP Configuration.....	66
Crew Configurations.....	70
Dual Dome Configuration.....	74
Legacy Configuration.....	77
Compatible Configurations for Media Server.....	78
Wireless Settings.....	79
Configuring Computers for DHCP.....	81
LAN Settings on ICM.....	87
Cache Settings on ICM.....	88
Setting Up Data Usage Alerts.....	89
CommBox Settings on ICM.....	90
Reset to Factory Configuration.....	91

## Selecting a Network Configuration

The ICM includes four Ethernet ports and a built-in wireless access point (WAP) that can be configured in a variety of ways to meet your vessel's needs.

Figure 7-1 Ethernet Ports and Wireless Access Point

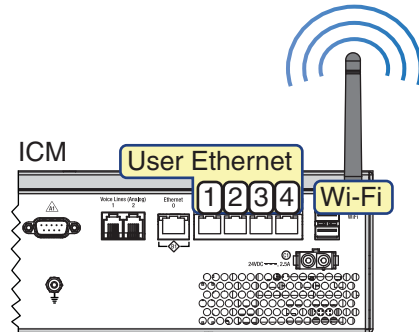

Some of the most common configurations can be set up directly from the TracPhone V3-IP web interface or the myKVH web portal:

Option	Description
Crew-1	Ports 1-3: Unrestricted access Port 4, Wi-Fi: User login required
Crew-2	Ports 1-2: Unrestricted access Ports 3-4, Wi-Fi: User login required
Crew-3	User login required
Crew-4	Ports 1-2: Unrestricted access Port 3, Wi-Fi: User login required Port 4: Static IP service
Dual Dome - Primary	For dual antenna installation only; Ports 1-3, Wi-Fi: Unrestricted access Port 4: Connect to secondary system
Dual Dome - Secondary	For dual antenna installation only; No user access; connect to primary
Legacy	Not used with TracPhone V3-IP
Standard (default)	Unrestricted access to Internet
Static IP	Ports 1-3, Wi-Fi: Unrestricted access Port 4: Static IP service

If your vessel requires a custom configuration, please contact KVH's Application Engineering Department at [appeng@kvh.com](mailto:appeng@kvh.com). If you need to connect a Media Server for IP-MobileCast service, see "Compatible Configurations for Media Server" on page 78.

---

## Important!

If you select the Static IP, Dual Dome-Secondary, or Legacy configuration, you will not be able to use "minivsat.kvh" to access the web interface. You will need to enter the IP address of the ICM (default is 192.168.0.9 in Static IP and Legacy modes, 192.168.0.10 in Dual Dome-Secondary mode). In addition, if you select the Dual Dome-Secondary or Legacy configuration, you will not be able to change any other settings on the Network Settings page.

---

To select an ICM network configuration, follow these steps:

1. At the TracPhone V3-IP web interface, click the **Settings** tab. Then click **Network Settings**.

*NOTE: You can also change the ICM's network configuration at the myKVH web portal ([www.mykvh.com](http://www.mykvh.com)). Go to the ICM > Network Configuration section of the Vessel Details page and select Configure Network.*

2. In Network Configuration, click **Edit**.
3. Select an option from the Configuration drop-down menu. Then click **Save**.

Figure 7-2 Selecting a Network Configuration

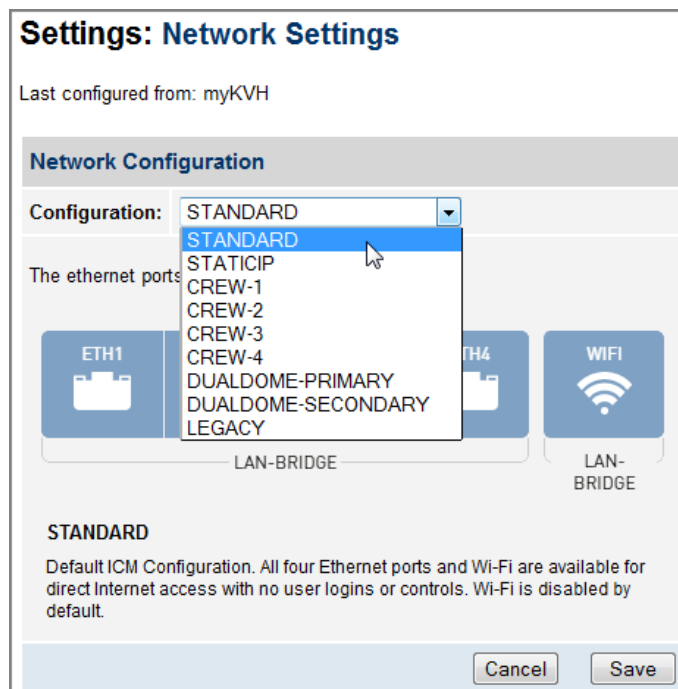

4. At the confirmation message, click **Save**.
5. Follow the additional steps for your chosen configuration:

["Standard Configuration" on page 64](#)

["Static IP Configuration" on page 66](#)

["Crew Configurations" on page 70](#)

["Dual Dome Configuration" on page 74](#)

["Legacy Configuration" on page 77](#)

*NOTE: Whenever you change the ICM's network configuration, its built-in wireless access point (WAP) reverts to Off, its default setting.*

## Standard Configuration

In a standard configuration, all four User Ethernet ports and the built-in Wi-Fi provide direct Internet access **without a user login**. This is the default configuration.

Figure 7-3 Standard Configuration

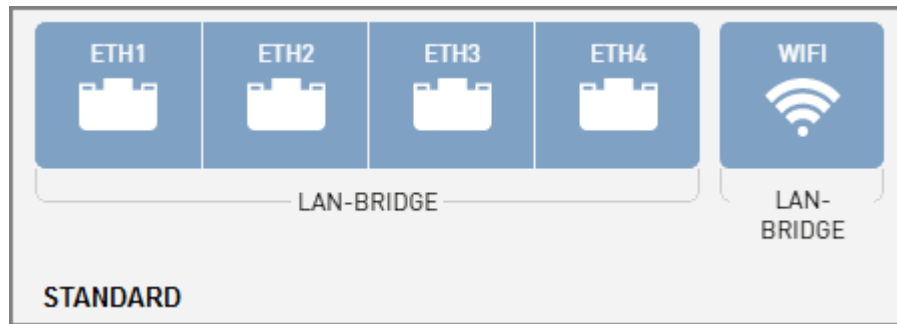

To set up the network in a standard configuration, follow these steps:

1. To enable the ICM's built-in wireless access point (WAP) for Wi-Fi access, follow the steps in ["Wireless Settings" on page 79](#).
2. Connect your computers and/or other network devices to the "User Ethernet" ports on the rear panel of the ICM. For example, you might wish to add an external WAP (or Wi-Fi router configured for bridge mode) to supplement Wi-Fi access. *Use straight-through 100 Mbps fast Ethernet UTP CAT5 cables (or better) with RJ45 connectors.*

Figure 7-4 Standard Configuration Wiring Example

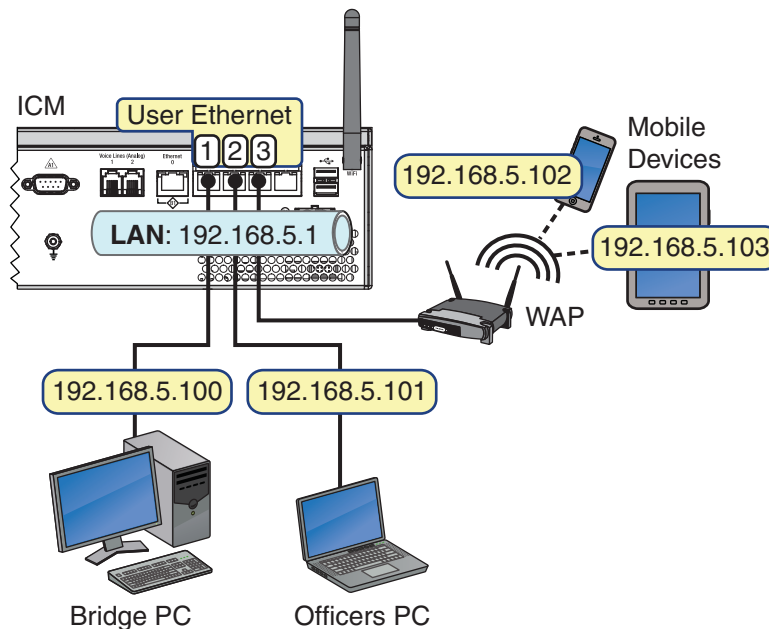



3. Make sure all computers are configured for DHCP addressing (see [“Configuring Computers for DHCP” on page 81](#)). Devices connected to the ICM (via Ethernet cables or Wi-Fi) will receive IP addresses from the ICM via DHCP. The ICM serves as a router.

*NOTE: By default, the ICM has a gateway of 192.168.5.1 and assigns IP addresses in the 192.168.5.100-200 range. If this configuration conflicts with an existing onboard network, you may change the settings at the TracPhone V3-IP web interface (go to Settings > Network Settings). See [“LAN Settings on ICM” on page 87](#) for details.*

## Static IP Configuration

In a static IP configuration, an onboard network device is assigned an IP address that can be accessed directly from the Internet. It does not receive an IP address from the ICM.

---

### Important!

You should only assign a static IP address to a secure device, such as a firewall router.

---

A static IP connection is commonly used by commercial vessels to enable remote monitoring and IT management from shore, and to allow a vessel's crew to access their company's secure VPN (virtual private network).

Figure 7-5 Common Static IP Applications

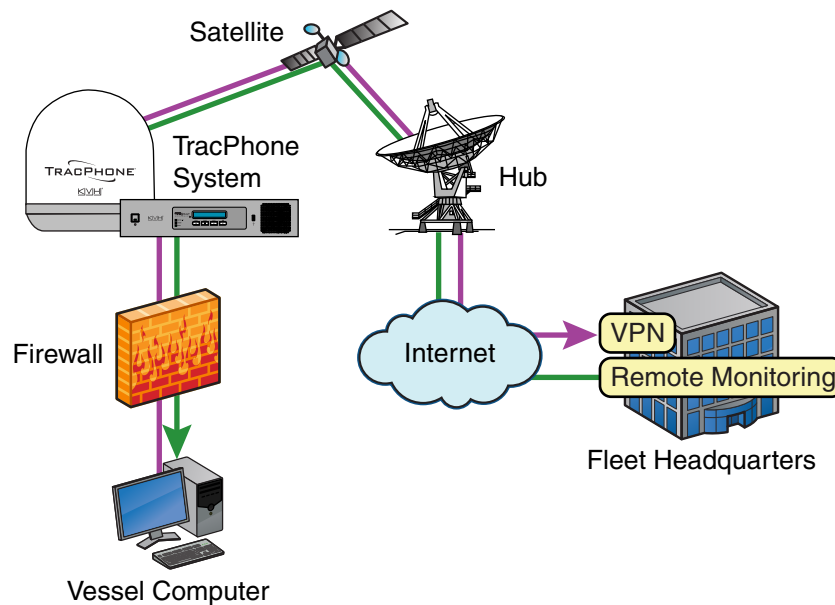

To set up the network in a static IP configuration, follow these steps:

1. Make sure the system is activated for mini-VSAT Broadband service.
2. Turn on the TracPhone system and make sure it is "Online." The system must remain online to allow KVH to set up your system over the satellite link.

- Fill out the online form at [www.kvh.com/staticip](http://www.kvh.com/staticip). Be sure to read all of the details on this form. An additional monthly fee for static IP service will apply.

### Important!

Only the "User Ethernet 4" port on the ICM can be used to connect static IP devices, as this port bypasses the ICM's local subnet to connect directly to the built-in modem.

- Connect your network device or computer to the "User Ethernet 4" port on the rear panel of the ICM. Use a straight-through CAT5 (or better) Ethernet cable with RJ45 connectors.

Figure 7-6 Static Configuration Wiring Example

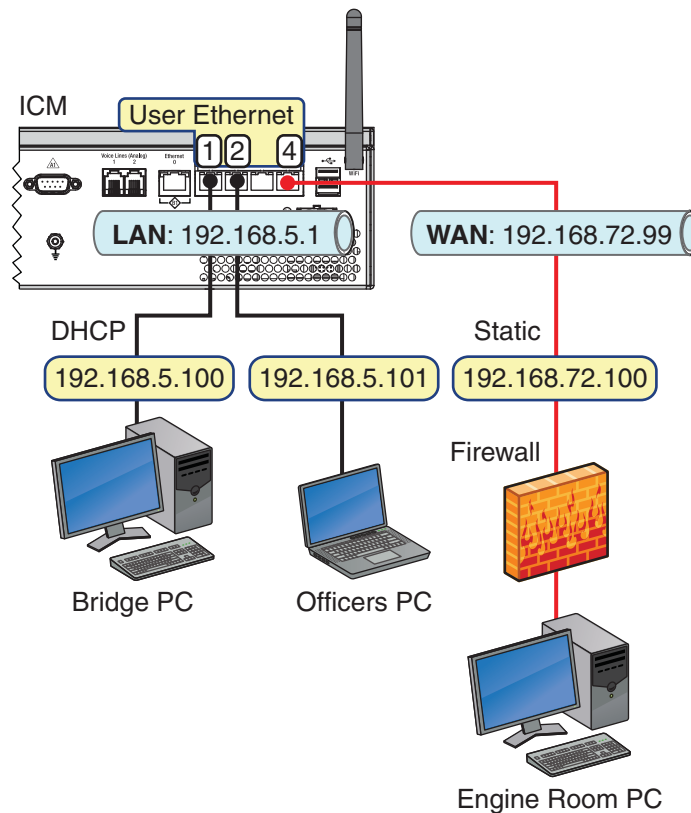

- At the TracPhone V3-IP web interface or myKVH web portal, select the **Static IP** network configuration. Refer to [“Selecting a Network Configuration” on page 61](#) for details.

Figure 7-7 Static IP Configuration



*NOTE: As an alternative, if you also need to control user access to the Internet, you can select the **Crew-4** configuration instead. See [“Crew Configurations” on page 70](#) for details.*

- When you receive an email from KVH confirming that your static IP address has been set up, configure the TCP/IP properties of your network device or computer with the static IP data provided in the email. For details on accessing your computer's TCP/IP properties, refer to [“Configuring Computers for DHCP” on page 81](#).

Figure 7-8 Static IP Data

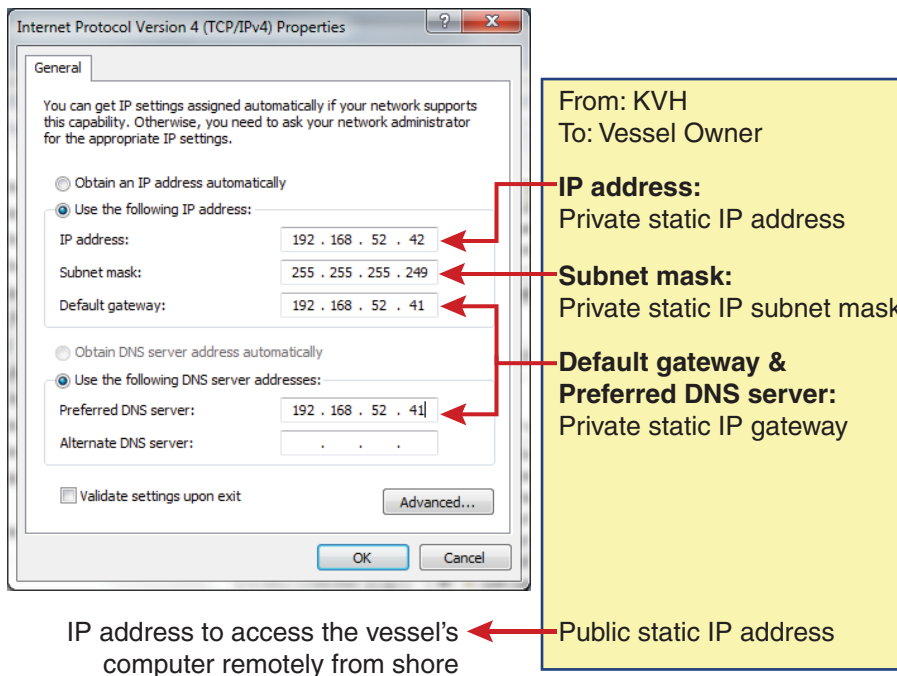

7. Connect all other (non-static IP) computers and/or network devices to "User Ethernet" ports 1-3 on the rear panel of the ICM. For example, you might wish to add an external WAP (or Wi-Fi router configured for bridge mode) to supplement Wi-Fi access. *Use straight-through 100 Mbps fast Ethernet UTP CAT5 cables (or better) with RJ45 connectors.*
8. To enable the ICM's built-in wireless access point (WAP) for Wi-Fi access, follow the steps in "[Wireless Settings](#)" on [page 79](#).
9. Make sure all non-static IP computers are configured for DHCP addressing (see "[Configuring Computers for DHCP](#)" on [page 81](#)). Devices connected to "User Ethernet" ports 1-3 and Wi-Fi will receive IP addresses from the ICM via DHCP. The ICM serves as a router.

*NOTE: By default, the ICM has a gateway of 192.168.5.1 and assigns IP addresses in the 192.168.5.100-200 range. If this configuration conflicts with an existing onboard network, you may change the settings at the TracPhone V3-IP web interface (go to Settings > Network Settings). See "[LAN Settings on ICM](#)" on [page 87](#) for details.*

## Crew Configurations

The crew configurations allow you to control user access to the system's Internet connection. Each crew configuration has certain "User Ethernet" ports (and possibly Wi-Fi) designated as "user login required." Users who connect to the system via one of these "Crew LAN" ports (or Wi-Fi) will be required to enter their user name and password to access the Internet. Once a user has consumed his/her data allotment for the current time period, access to the system is denied until the next time period begins and the user's full allotment is restored. The "Ops LAN" ports, if any, provide direct Internet access without a user login. There are four basic crew configuration options available out of the box, as explained below.

### Crew-1 Configuration

Ethernet Ports	Internet Access
1, 2, and 3	Unrestricted (Ops LAN)
4 and Wi-Fi	User login required (Crew LAN)

Figure 7-9 Crew-1 Configuration Diagram

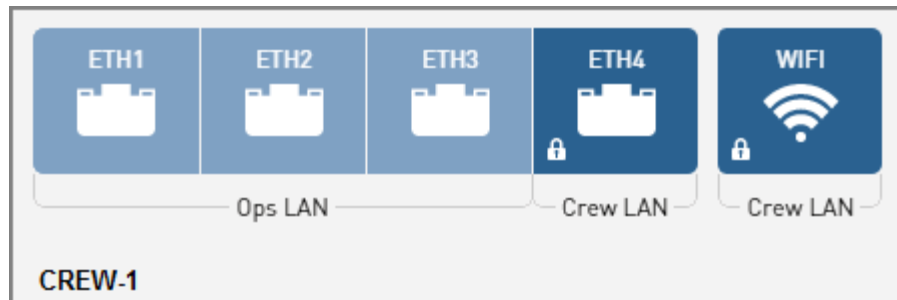

### Crew-2 Configuration

Ethernet Ports	Internet Access
1 and 2	Unrestricted (Ops LAN)
3, 4, and Wi-Fi	User login required (Crew LAN)

Figure 7-10 Crew-2 Configuration Diagram

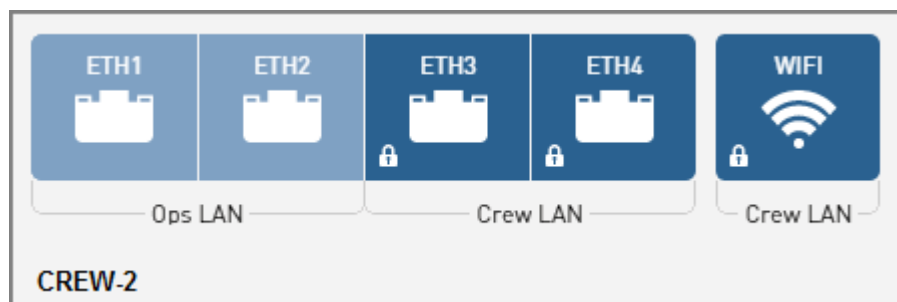

### Crew-3 Configuration

Ethernet Ports	Internet Access
1, 2, 3, 4, and Wi-Fi	User login required (Crew LAN)

Figure 7-11 Crew-3 Configuration Diagram

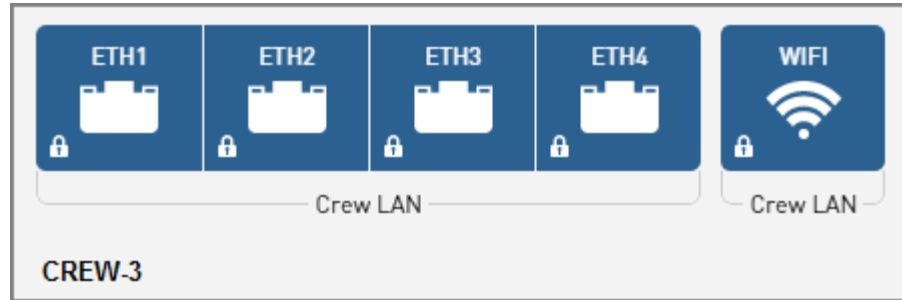

### Crew-4 Configuration

Ethernet Ports	Internet Access
1 and 2	Unrestricted (Ops LAN)
3 and Wi-Fi	User login required (Crew LAN)
4	Static IP (WAN)

NOTE: See *“Static IP Configuration”* on page 66 for details about static IP and its additional setup steps.

Figure 7-12 Crew-4 Configuration Diagram

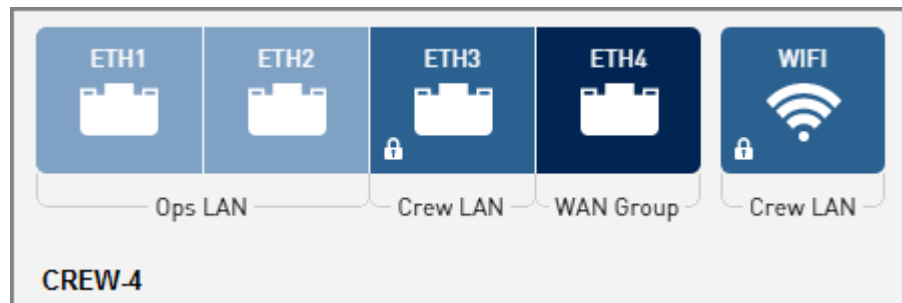

To set up the network in a crew configuration, follow these steps:

1. At the TracPhone V3-IP web interface or myKVH web portal, select the desired **Crew** network configuration. Refer to *“Selecting a Network Configuration”* on page 61 for details.
2. Connect the Crew computers and/or network devices to the “User Ethernet ports” on the ICM that are designated “Crew LAN.” Use straight-through 100 Mbps fast Ethernet UTP CAT5 cables (or better) with RJ45 connectors.

3. Connect the Operations computers and/or network devices to the "User Ethernet" ports on the ICM that are designated "Ops LAN," if any.

Figure 7-13 Crew-2 Configuration Wiring Example

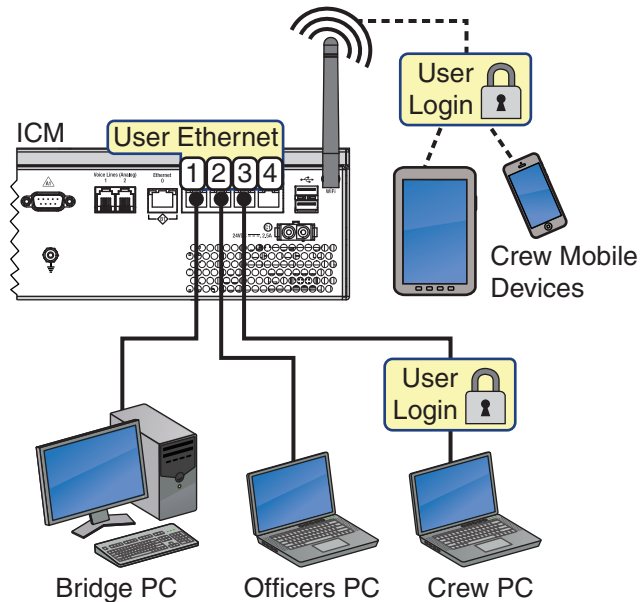

4. To enable the ICM's built-in wireless access point (WAP) for Wi-Fi access, follow the steps in ["Wireless Settings" on page 79](#).
5. Make sure all computers are configured for DHCP addressing (see ["Configuring Computers for DHCP" on page 81](#)). Devices connected to the ICM (via Ethernet cables or Wi-Fi) will receive IP addresses from the ICM via DHCP. The ICM serves as a router.
6. If you selected the Crew-4 configuration, connect your static IP device to "User Ethernet" port 4 and follow the additional setup steps explained in ["Static IP Configuration" on page 66](#).

*NOTE: By default, the ICM has a gateway of 192.168.5.1 and assigns IP addresses in the 192.168.5.100-200 range. If this configuration conflicts with an existing onboard network, you may change the settings at the TracPhone V3-IP web interface (go to Settings > Network Settings). See ["LAN Settings on ICM" on page 87](#) for details.*



- Set up all of the user names and passwords, as well as daily, weekly, or monthly data allocations for each user, at the myKVH web portal ([www.mykvh.com](http://www.mykvh.com)). Go to the Terminal > Data Plan section of the Vessel Details page and select Crew Data Allocation.

Figure 7-14 myKVH Crew Data Allocation: Users (Example)

User Name ▲	First Name	Last Name	Allocation Profile
Isvensen	Lars	Svensen	Crew
jdoe	John	Doe	Crew

Figure 7-15 myKVH Crew Data Allocation: Allocation Profiles (Example)

Name ▲	Amount	Period
Crew	175 MB	month
Operations	1500 MB	month

## Dual Dome Configuration

The dual dome configuration allows you to connect a second TracPhone V-IP Series antenna as a backup system. Whenever the primary system loses its connection to the mini-VSAT Broadband service (e.g., its view of the satellite becomes blocked), all voice and data traffic will automatically get routed to the secondary system.

---

### Important!

Contact KVH Technical Support before you configure the secondary ICM (see [“Contacting KVH Technical Support” on page 134](#)). KVH will need to modify a setting on the secondary ICM over the air to support a dual dome configuration.

---

To set up the network in a dual dome configuration, follow these steps:

1. At the web interface for the **secondary** system, or at the myKVH web portal, select the **Dual Dome - Secondary** network configuration on the secondary system. Refer to [“Selecting a Network Configuration” on page 61](#) for details.

Figure 7-16 Dual Dome - Secondary Configuration

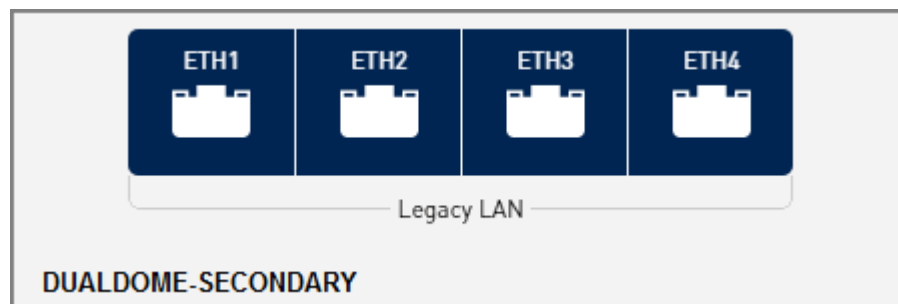

*NOTE: Once the secondary system is configured for Dual Dome-Secondary, you will need to enter 192.168.0.10 (and not minivsat.kvh) to access the secondary system's web interface.*

- At the web interface for the **primary** system, or at the myKVH web portal, select the **Dual Dome - Primary** configuration on the primary system. Refer to [“Selecting a Network Configuration”](#) on page 61 for details.

Figure 7-17 Dual Dome - Primary Configuration

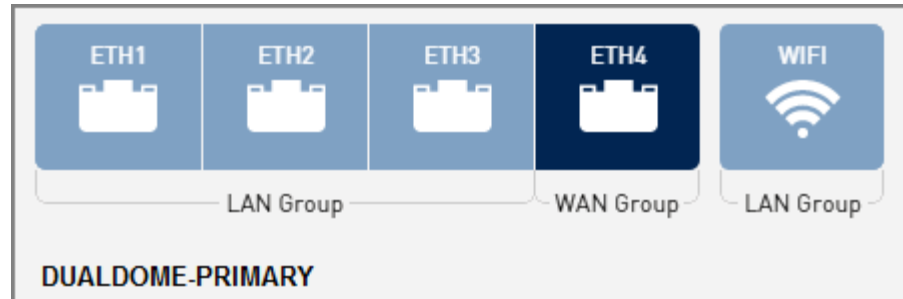

- Connect an Ethernet cable from one of the “User Ethernet” ports on the secondary system’s ICM to “User Ethernet” port 4 on the primary system’s ICM.

Figure 7-18 Dual Dome Wiring (Example)

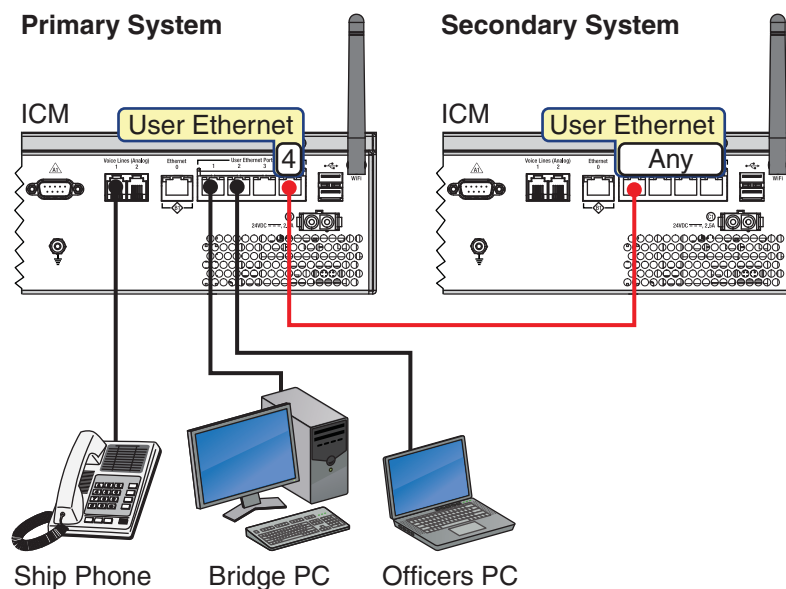

- Connect your computers and/or other network devices to “User Ethernet” ports 1-3 and Wi-Fi on the primary system’s ICM. Use *straight-through 100 Mbps fast Ethernet UTP CAT5 cables (or better) with RJ45 connectors.*

5. Make sure all computers are configured for DHCP addressing (see [“Configuring Computers for DHCP” on page 81](#)). Devices connected to the primary system’s ICM (via Ethernet cables or Wi-Fi) will receive IP addresses from the ICM via DHCP. The ICM serves as a router.

*NOTE: By default, the ICM has a gateway of 192.168.5.1 and assigns IP addresses in the 192.168.5.100-200 range. If this configuration conflicts with an existing onboard network, you may change the settings at the TracPhone V3-IP web interface (go to Settings > Network Settings). See [“LAN Settings on ICM” on page 87](#) for details.*

6. To enable the ICM’s built-in wireless access point (WAP) for Wi-Fi access, follow the steps in [“Wireless Settings” on page 79](#).

## Legacy Configuration

In a legacy configuration, many of the ICM's features are disabled to make the configuration similar to a standard TracPhone V7 or V3.

---

### Important!

Use the legacy configuration only if the ICM is replacing an older TracPhone V7 or V3 antenna system's belowdecks equipment. Do not use this mode with a TracPhone V3-IP, V7-IP, V11, or V11-IP antenna system.

---

Figure 7-19 Legacy Configuration

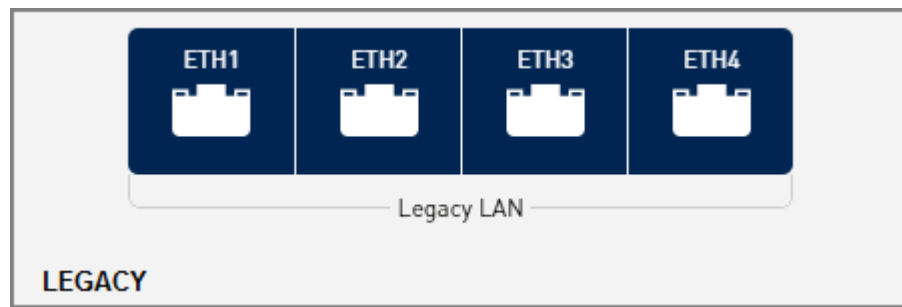

## Compatible Configurations for Media Server

If you wish to connect a Media Server to the TracPhone system to deliver IP-MobileCast service to your vessel, you need to set the ICM to one of the following network configurations:

- Static IP
- Crew-4
- Dual Dome - Primary/Dual Dome Secondary

The Media Server requires a connection to the ICM's WAN Group, in addition to a LAN connection. Refer to the Media Server Installation Guide for complete details about installing and configuring the Media Server.

*NOTE: See "IP-MobileCast Features" on page 104 for details about the Media Server and IP-MobileCast service.*

## Wireless Settings

With Wi-Fi enabled, vessel devices can connect to the ICM via its built-in wireless access point (WAP) and receive IP addresses from the ICM via DHCP.

---

### Important!

The range of the ICM's WAP will depend on the layout and structure of the vessel. For example, wireless signals degrade when passing through bulkheads and near metal masses. If the system is installed on a steel vessel, you might need a special WAP and the services of a technician with advanced networking expertise.

---

Figure 7-20 Wireless DHCP (Example)

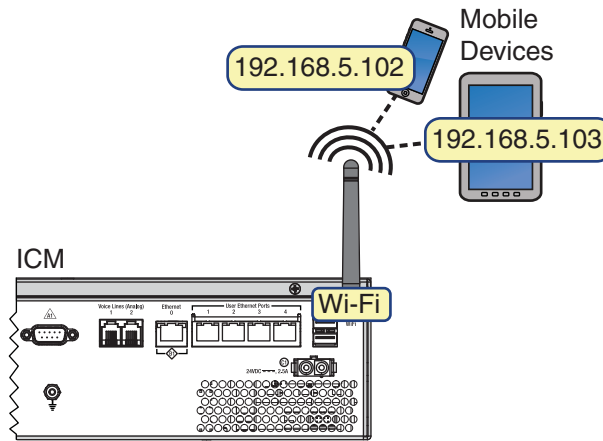

*NOTE: If the optional CommBox software is enabled, or the ICM is configured for Dual Dome-Secondary or Legacy mode, the Network Settings page of the ICM/myKVH will not contain any configurable fields.*

To enable and configure the ICM's Wi-Fi connection, follow these steps:

1. At the TracPhone V3-IP web interface, click the **Settings** tab. Then click **Network Settings**.

*NOTE: You can also change the ICM's Wi-Fi settings at the myKVH web portal ([www.mykvh.com](http://www.mykvh.com)). Go to the ICM > Network Configuration section of the Vessel Details page and select Wi-Fi Settings.*

2. In Wireless Settings, click **Edit**.
3. If the Login window appears, log in with the Administrator password.

4. Set the following wireless options:

**State:** Select On.

**SSID:** Enter a unique name for the vessel network.

**Protocol:** Select either 802.11b or 802.11g.

**Security:** Select either security type – WPA2 or WEP (128-bit).

**Password/Passphrase:** If you selected WPA2, enter a password (between 8-20 characters). If you selected WEP, enter a passphrase (must be 13 characters).

**Channel:** Keep the default, or select any channel for wireless communications.

---

## Important!

Failure to apply security settings will make your vessel's wireless network vulnerable to outside intrusion.

---

Figure 7-21 Wireless Settings

Wi-Fi Settings	
State:	<input checked="" type="radio"/> On <input type="radio"/> Off (default)
SSID:	<input type="text" value="MyVesselNetwork"/> (Up to 32 characters)
IP Address:	<input type="text" value="192 . 168 . 5 . 1"/>
Protocol:	<input type="text" value="802.11b"/>
Security:	<input type="text" value="WPA2"/>
Password:	<input type="password" value="••••••••"/> (between 8 to 20 characters)
Channel:	<input type="text" value="7"/>
<input type="button" value="Cancel"/> <input type="button" value="Save"/>	

5. Click **Save**.
6. At the confirmation message, click **Save**.
7. Make sure your computers are equipped with a wireless network interface card and configured for DHCP addressing (see [“Configuring Computers for DHCP”](#) on page 81).



## Configuring Computers for DHCP

To configure your computers for DHCP, allowing them to receive IP addresses from the ICM, follow the steps for your operating system:

- [“Windows 10 DHCP Settings”](#)
- [“Windows 8 DHCP Settings” on page 82](#)
- [“Windows 7 or Windows Vista DHCP Settings” on page 83](#)
- [“Windows XP DHCP Settings” on page 84](#)
- [“Mac OS X DHCP Settings” on page 86](#)

### Windows 10 DHCP Settings

To configure a Windows 10 computer for DHCP addressing, follow these steps:

1. Open the **Network and Sharing Center**. The easiest way to get there is to simply type the name in the search box on the taskbar. You can also navigate to it from the Start menu: Settings > Network & Internet > Ethernet > Network and Sharing Center.
2. In Network and Sharing Center, click the **Ethernet** link for the Ethernet connection you are using for mini-VSAT Broadband.
3. In the Ethernet Status dialog box, click **Properties**. *If this screen doesn't appear, just skip to Step 4.*
4. In the Ethernet Properties dialog box, on the **Networking** tab, select **Internet Protocol Version 4**, and then click **Properties**.
5. In the Internet Protocol Properties dialog box, select **Obtain an IP address automatically** and **Obtain DNS server address automatically**. Then click **OK**.

Figure 7-22 Windows 10- Internet Protocol Properties

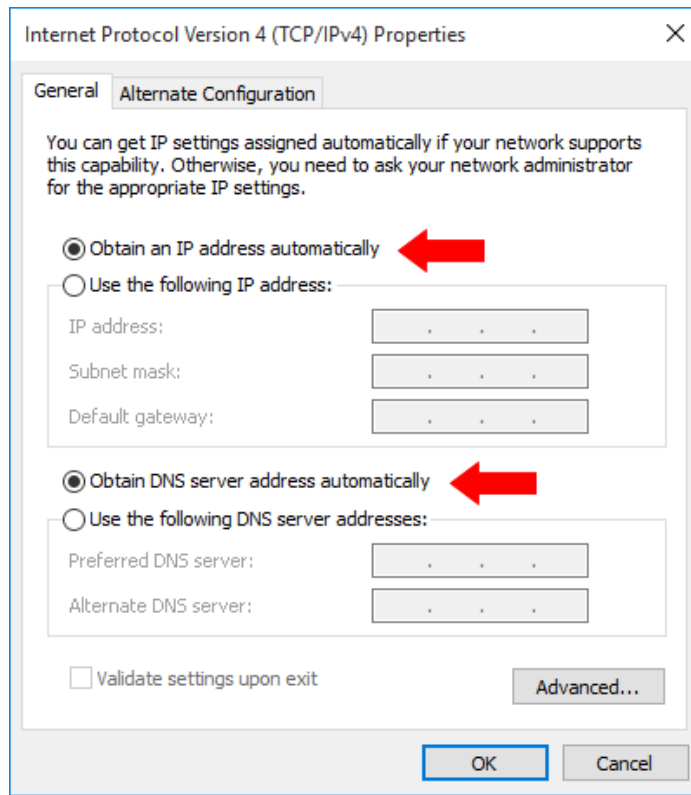

6. In the Ethernet Properties dialog box, click **Close**.

## Windows 8 DHCP Settings

To configure a Windows 8 computer for DHCP addressing, follow these steps:

1. In Control Panel, double-click **Network and Sharing Center**.  
*To open the Control Panel, go to the desktop, select Settings from the Charms bar, then select Control Panel.*
2. In Network and Sharing Center, double-click the **Ethernet** link for the Ethernet connection you are using for mini-VSAT Broadband.
3. In the Ethernet Status dialog box, click **Properties**. *If this screen doesn't appear, just skip to Step 4.*
4. In the Ethernet Properties dialog box, on the **Networking** tab, select **Internet Protocol Version 4**, and then click **Properties**.

5. In the Internet Protocol Properties dialog box, select **Obtain an IP address automatically** and **Obtain DNS server address automatically**. Then click **OK**.

Figure 7-23 Windows 8 - Internet Protocol Properties

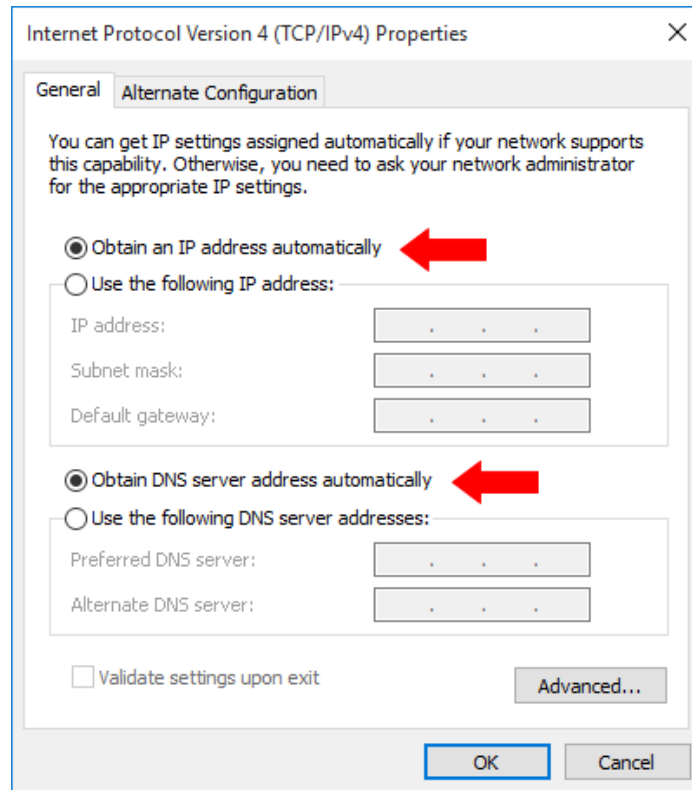

6. In the Ethernet Properties dialog box, click **Close**. Then click **Close** in the Ethernet Status dialog box.

## Windows 7 or Windows Vista DHCP Settings

To configure a Windows 7 or Windows Vista computer for DHCP addressing, follow these steps:

1. In Control Panel, double-click **Network and Sharing Center**. (You might need to click **Network and Internet** first.) *You can find the Control Panel either through the Start menu or "My Computer."*
2. In Network and Sharing Center, double-click the **Local Area Connection** (Windows 7) or **View Status** (Windows Vista) for the Ethernet connection you are using for mini-VSAT Broadband.

3. In the Local Area Connection Status dialog box, click **Properties**. *If this screen doesn't appear, just skip to Step 4.*
4. In the Local Area Connection Properties dialog box, click the **Networking** tab, select **Internet Protocol Version 4**, and then click **Properties**.
5. In the Internet Protocol Properties dialog box, select **Obtain an IP address automatically** and **Obtain DNS server address automatically**. Then click **OK**.

Figure 7-24 Windows 7/Windows Vista - Internet Protocol Properties

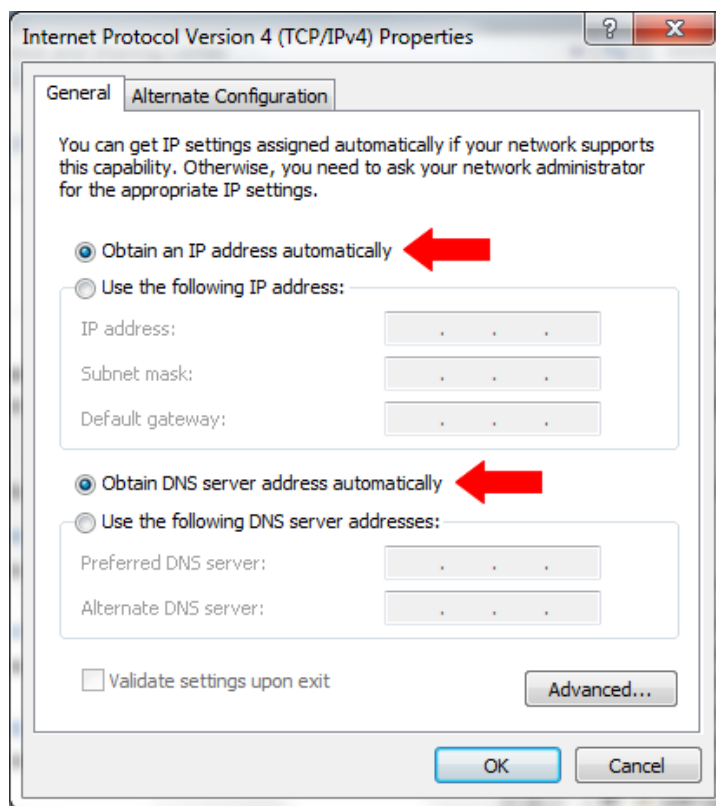

6. In the Local Area Connection Properties dialog box, click **OK**.

## Windows XP DHCP Settings

To configure a Windows XP computer for DHCP addressing, follow these steps:

1. In Control Panel, double-click **Network Connections**. *You can find the Control Panel either through the Start menu or "My Computer."*

2. In Network Connections, double-click the **Local Area Connection** for the Ethernet connection you are using for mini-VSAT Broadband.
3. In the Local Area Connection Status dialog box, click the **General** tab. Then click **Properties**. *If this screen doesn't appear, simply skip to Step 4.*
4. In the Local Area Connection Properties dialog box, click the **General** tab, select **Internet Protocol (TCP/IP)**, and then click **Properties**.
5. In the Internet Protocol (TCP/IP) Properties dialog box, click the **General** tab. Then select **Obtain an IP address automatically** and **Obtain DNS server address automatically**. Then click **OK**.

Figure 7-25 Windows XP - Internet Protocol (TCP/IP) Properties

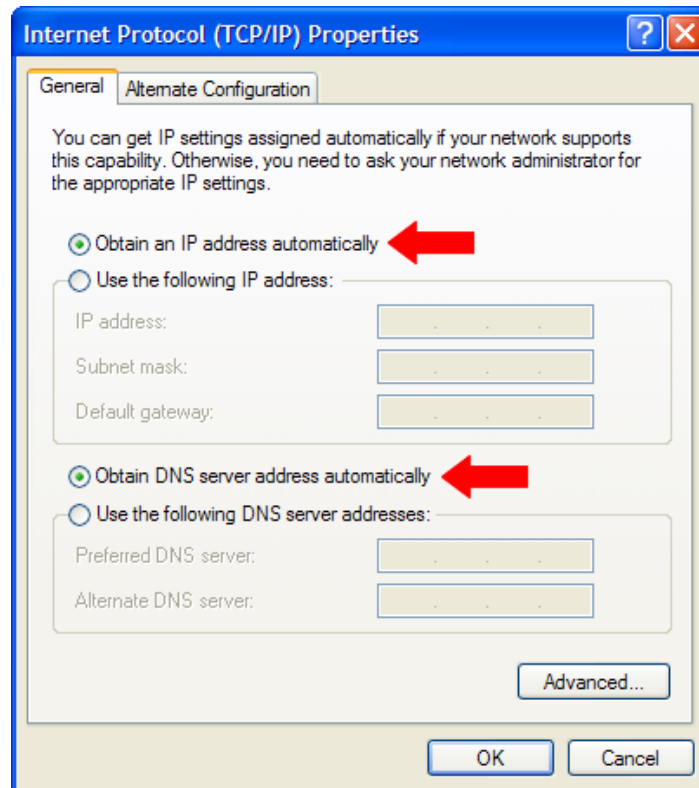

6. In the Local Area Connection Properties dialog box, click **OK**.
7. Restart your computer.

## Mac OS X DHCP Settings

To configure a Mac OS X computer for DHCP addressing, follow these steps:

1. In System Preferences, click **Network**.
2. In the Network dialog box, select **Ethernet** then set the following:
  - Location: **Automatic**
  - Configure IPv4: **Using DHCP**

Figure 7-26 Mac OS X - Network

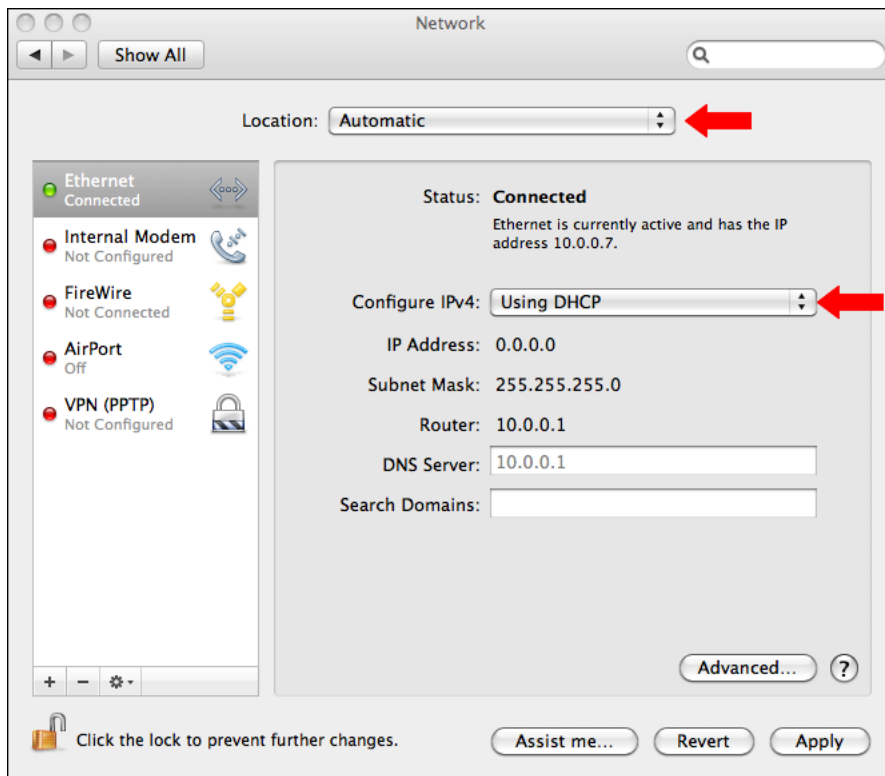

3. Click **Apply**.
4. Restart the computer.

## LAN Settings on ICM

By default, the ICM has a gateway address of 192.168.5.1 and assigns IP addresses in the 192.168.5.100-200 range (DHCP configurations only). If this configuration conflicts with another onboard network, you may change these settings.

---

### Important!

The default LAN settings work well for most installations. Do not change these settings unless absolutely necessary.

---

*NOTE: If the optional CommBox software is enabled, or the ICM is configured for Dual Dome-Secondary or Legacy mode, the Network Settings page of the ICM will not contain any configurable fields.*

To change the ICM's LAN settings, follow these steps:

1. At the TracPhone V3-IP web interface, click the **Settings** tab. Then click **Network Settings**.
2. In LAN Settings, click **Edit**.
3. If the Login window appears, log in with the Administrator password.
4. Modify the IP Address, Subnet Mask, and DHCP Mode settings as necessary.
5. Click **Save**.
6. At the confirmation message, click **Save**.

Figure 7-27 LAN Settings

LAN Settings	
IP Address:	192 . 168 . 5 . 1 <small>Note: 192.168.0.1 is reserved for system use. Be sure to assign a different IP address.</small>
Subnet Mask:	255 . 255 . 255 . 0
DHCP Mode:	<input checked="" type="radio"/> Enabled (default) <input type="radio"/> Disabled DHCP Start: 192 . 168 . 5 . 100 DHCP End: 192 . 168 . 5 . 150
<a href="#">Reset to Defaults</a> <input type="button" value="Cancel"/> <input type="button" value="Save"/>	

## Cache Settings on ICM

By default, the local web cache is enabled on the ICM. This feature allows the ICM to temporarily store the content of web pages you visit, so they will load faster on subsequent visits. The local web cache should stay enabled to ensure the best possible web browsing experience. However, it can be disabled if necessary.

---

### Important!

Do not change the cache settings unless absolutely necessary.

---

*NOTE: If the optional CommBox software is enabled, or the ICM is configured for Dual Dome-Secondary or Legacy mode, the Network Settings page of the ICM will not contain any configurable fields.*

To disable the local web cache on the ICM, follow these steps:

1. At the TracPhone V3-IP web interface, click the **Settings** tab. Then click **Network Settings**.
2. In Cache Settings, click **Edit**.
3. If the Login window appears, log in with the Administrator password.
4. Select **Disabled**.
5. Click **Save**.
6. At the confirmation message, click **Save**.

Figure 7-28 Cache Settings

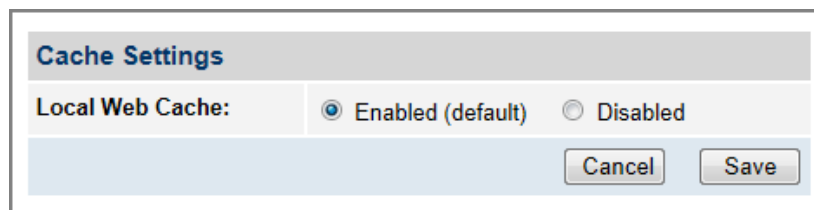

Cache Settings

Local Web Cache:  Enabled (default)  Disabled

Cancel Save



## Setting Up Data Usage Alerts

You can set up automatic email and/or SMS text message alerts to notify you (and others of your choosing) when your vessel's data usage reaches certain thresholds, and prevent surprises on your airtime bill. At your option, alerts can be sent when the vessel has consumed a certain percentage of its monthly allowance and/or when usage exceeds that monthly allowance by a certain amount of your choosing.

To set up alerts, log into the myKVH web portal ([www.mykvh.com](http://www.mykvh.com)), go to the Terminal > Data Plan section of the Vessel Details page, and select **Manage Alerts**.

Figure 7-29 Managing Alerts at myKVH (Example)

### Manage Alerts

#### Allowance Alerts

Send alerts when usage *reaches* the following thresholds of Monthly Allowance:

50%  
  80%  
  100%  
  200%  
  300%

#### Overage Alerts

Send alerts when usage *goes over* the Monthly Allowance by the following amount:

Every

#### Who To Notify

##### Email

Email Address

master\_satisfaction@kvh.com ×

##### Text / SMS

Phone number

+1 401-555-1212 ×  
 +1 401-555-0000 ×

or

*Email and SMS notifications are provided as a courtesy only to assist you in managing your data usage. In the event that you do not receive a notification, you will remain responsible for all airtime charges, even if such charges exceed your plan allowance.*

## CommBox Settings on ICM

If the optional CommBox software is enabled, the ICM's network settings are configured by KVH over the air. The Network Settings page of the ICM and myKVH will not contain any configurable fields.

*NOTE: See "CommBox Features" on page 102 for details on enabling the CommBox software.*

For complete details about the CommBox software, refer to the CommBox manual. To view the CommBox manual, follow these steps:

1. At the TracPhone V3-IP web interface, click the **CommBox** tab.

Figure 7-30 CommBox Tab



2. Click **Log in to CommBox Control**.
3. Log into the CommBox web page with your CommBox user name and password.

*NOTE: The CommBox user name and password differs from the ICM's Administrator password.*

4. At the CommBox web page, click the **Help** tab.

Figure 7-31 CommBox Help Tab

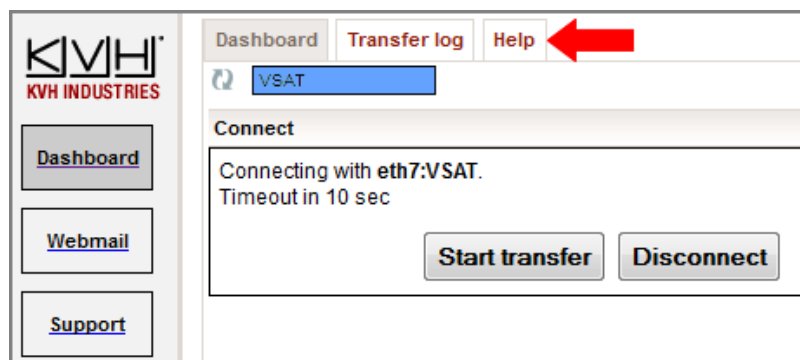

## Reset to Factory Configuration

If the system's network becomes corrupted such that you can no longer access the TracPhone V3-IP web interface, you can reset the system to its original factory settings.

---

### Important!

Perform a factory reset only if directed by KVH Technical Support. This function should only be used as a last resort when all other options fail.

---

The following settings are included in the reset:

- Reverts to Standard network configuration
- Deletes any custom CommBox configurations
- Clears any configured no-transmit zones
- Sets the ICM's LCD brightness to High

To reset the system to its factory settings, follow these steps:

1. At the ICM's front panel, press **MENUS** until the display shows "DIAGNOSTIC TOOLS."
2. Press **ACCEPT**.
3. At "KVH SUPPORT IP," press **NEXT**.
4. At "CALIBRATE GYROS," press **NEXT**.
5. At "FACTORY RESET," press **ACCEPT**.
6. At "PROCEED WITH RESET?," press **ACCEPT**.

The system reverts to its original factory settings. Do not power off the system while this reset is in progress.

Figure 7-32 Factory Reset

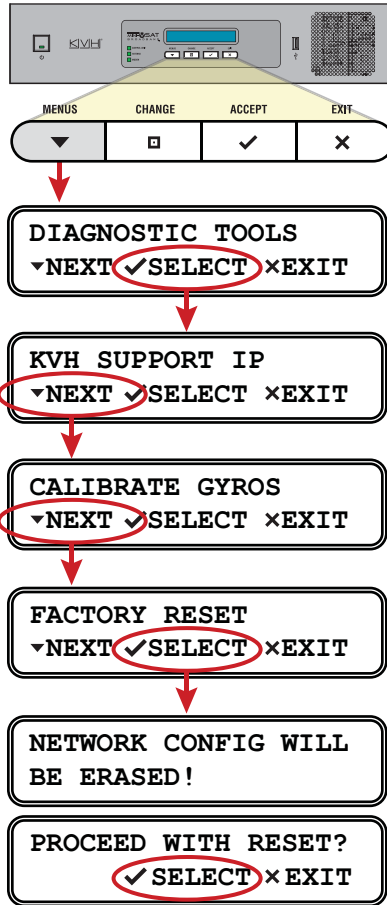

Press **MENUS** until **DIAGNOSTIC TOOLS** is displayed.



# 8. Data Connections

This section explains how to connect to the Internet via the mini-VSAT Broadband service. It also provides a number of suggestions for minimizing the amount of data that's transferred over the network, and provides an overview of the CommBox and IP-MobileCast options.

## Contents

Internet Access Overview .....	95
Tips for Minimizing Data Usage.....	97
CommBox Features .....	102
IP-MobileCast Features .....	104

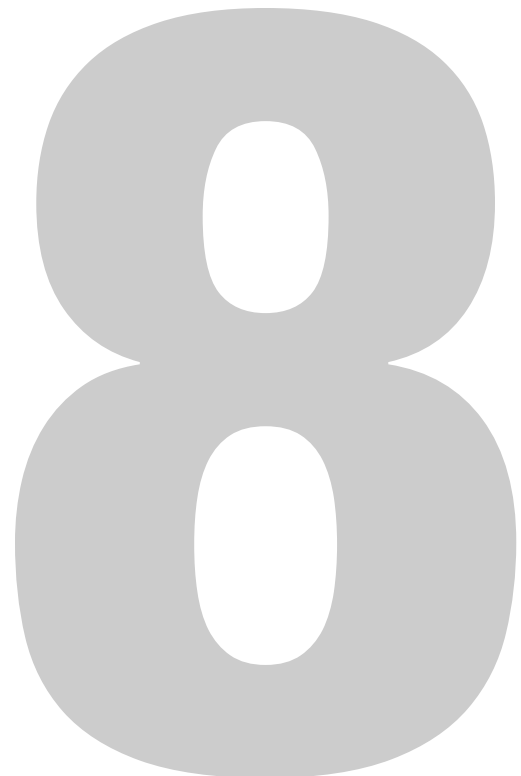



## Internet Access Overview

While the TracPhone system is online with the mini-VSAT Broadband service, you can perform all of the same Internet tasks you perform at home:

- Email
- Web browsing
- Weather and chart updates
- Instant messages
- Corporate network access (VPN)
- Data transfers

---

### **Important!**

High-bandwidth applications, such as peer-to-peer file sharing, web cameras, streaming media, and high-speed gaming, are not supported by fixed rate plans. For details, be sure to read all of the service terms and conditions in the End User Agreement, which can be found at [www.kvh.com/mvbcustomercenter](http://www.kvh.com/mvbcustomercenter).

---

## Connecting to the Internet

To connect to the Internet, follow these steps:

1. Make sure the TracPhone system is online.
2. Open a web browser window on any device connected to the vessel's network.
3. If a login screen appears, log in with your username and password. Then set the slider to the desired duration of your session and click **Start Internet Connection**. When you are done using the Internet, click **Disconnect & Log Out**.

Figure 8-1 User Login (Crew Configuration Only)

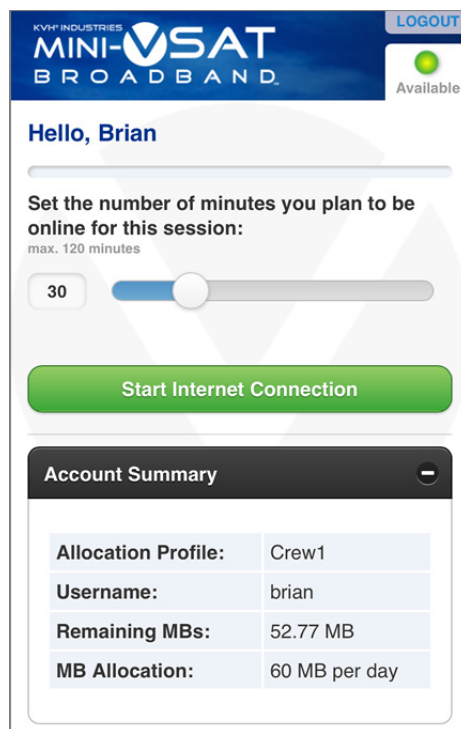

The screenshot displays the user login interface for MINI-SAT BROADBAND. At the top, there is a header with the logo and a 'LOGOUT' button. Below the header, the user is greeted with 'Hello, Brian'. A slider control allows the user to set the number of minutes they plan to be online for this session, with a maximum of 120 minutes. The current setting is 30 minutes. A green button labeled 'Start Internet Connection' is positioned below the slider. At the bottom, there is an 'Account Summary' section with a minus sign icon to collapse it. The summary table contains the following information:

Allocation Profile:	Crew1
Username:	brian
Remaining MBs:	52.77 MB
MB Allocation:	60 MB per day

*NOTE: For details on configuring users, see “Crew Configurations” on page 70.*

4. If you're unable to connect with a computer, make sure it is configured for DHCP addressing. Refer to “Configuring Computers for DHCP” on page 81.

## Tips for Minimizing Data Usage

The configurations of operating systems, web browsers, and applications generally assume the unlimited, always-on broadband connection that is a reality on land. As such, they will often try to connect to the Internet on their own to download updates and transfer files. They will also operate without any regard to the amount of traffic they generate to perform routine tasks.

While high data usage is not much of a concern with a broadband connection on shore, avoiding excessive data usage is worthwhile when using the mini-VSAT Broadband service at sea, especially if you are charged by the megabyte.

Consider the guidelines in this section to eliminate unnecessary background Internet activity and minimize the amount of data you consume. Adopting these guidelines will help ensure you use the service in the most efficient and cost-effective manner.

---

### **Important!**

You are responsible for **all** data transferred to/from your network devices, including inadvertent downloads by applications running in the background.

---

*NOTE: At the myKVH web portal, you can set up email and/or SMS text alerts to notify you when your vessel's data usage reaches certain thresholds. See ["Setting Up Data Usage Alerts"](#) on page 89 for details.*



## Preventing Automatic Updates

The default configuration of many applications allow them to download updates from the Internet automatically, without any user interaction. KVH recommends that, while the device is being used at sea, you set up these applications either to not check for updates or to notify you before downloading them. These applications include:

- Anti-virus software
- Spyware protection software
- Web browser
- Mobile apps
- Adobe Acrobat<sup>®</sup> Reader
- Apple iTunes<sup>®</sup>
- Windows Update or Mac Software Update

*NOTE: Android devices offer a “Restrict Background Data” setting, which will prevent background updates from all installed apps.*

Any malicious applications hidden on your device may also use your Internet connection without your knowledge. Therefore, prior to using your device onboard the vessel, run a full system scan with an up-to-date anti-virus and spyware detection/removal utility.

## Disabling Automatic File Backup and Synchronization

The default configuration of many cloud-based file sharing and syncing tools allow them to upload files (including photos, videos, and other media) and synchronize mobile devices without any user interaction. KVH recommends that, like preventing automatic updates, you set up these services for manual backup and synchronization only. These cloud storage services include:

- Apple iCloud<sup>®</sup>
- Google Drive<sup>™</sup>
- Microsoft SkyDrive<sup>®</sup>
- Dropbox<sup>™</sup>
- Box

## Firewall Protection

A firewall can prevent most applications from accessing the Internet without your knowledge, as well as protect your devices from outside intrusion. KVH recommends that you enable the firewall on your router or individual network devices.

## Web Browser Settings

All popular web browsers, such as Internet Explorer, Mozilla Firefox, Google Chrome, and Apple Safari, offer various tools that allow you to minimize the amount of data they consume. Consider these options:

### Limit Multimedia Downloads

Set up your browser to disable multimedia content embedded in websites from playing automatically.

### Enable Pop-Up Blocker

Many consumer websites overlay small pop-up windows over the main page to launch ads. Turn on your web browser's pop-up blocker to prevent these from running and consuming data. Your web browser might also offer tools to block websites or types of content that you specify, or allow access to only certain websites that you trust.

### Maximize Caching of Web Pages

By default, web browsers automatically refresh the content they have stored in their cache. If the browser finds a new version of a website is available, it will delete the version it has stored locally and download the new one. KVH recommends you set up your browser to download new versions of web pages only when you visit them, and also increase the size of the cache to the maximum level permitted for your browser.

### Disable Preloading of Web Pages

The mobile version of Google Chrome (the default browser on Android devices) speeds up web browsing by preloading the destination web pages of links shown on the currently viewed page. This feature consumes an enormous amount of data and should be disabled.

### Avoid Multiple Browsing Tabs

KVH recommends that you browse the web using a single open browser tab. Any tabs left open in the background may continue to consume data.

## Data-Intensive Applications

The following applications can consume a great deal of data whenever they are active or running in the background:

- Skype (*uses 40 MB per month just to maintain your status, in addition to the data used for actual calls and chats*)
- RSS feeds and widgets presenting real-time information (*e.g., news, weather, stocks ticker, sports scores, etc.*)
- Social media (*e.g., YouTube and Facebook*)
- Peer-to-peer (P2P) file sharing (*e.g., BitTorrent, Gnutella, etc.*)

If you are charged by the megabyte on a metered rate plan, use caution when running these types of applications to help prevent unpleasant surprises on your airtime bill.

---

### Important!

Some high-bandwidth applications, such as peer-to-peer file sharing, web cameras, streaming media, and high-speed gaming, are not supported by fixed rate plans. For details, be sure to read all of the service terms and conditions in the End User Agreement, which can be found at [www.kvh.com/mvbcustomercenter](http://www.kvh.com/mvbcustomercenter).

---

## Mobile Websites

Many organizations now offer alternative versions of their websites optimized for mobile devices. Although designed for smartphone users on a cellular connection, you can access these mobile websites on a desktop or laptop as well. KVH recommends you visit mobile websites instead of full sites whenever possible to minimize the amount of data used.

To view the mobile version of a website, simply replace the “www” in the address with an “m”. For example, to view the mobile version of CNN’s website, you would enter “m.cnn.com” in your web browser.

## Disabling Wi-Fi Access on Mobile Devices

If you don’t intend to use your mobile device to access the Internet over the mini-VSAT Broadband service, disable the mobile device’s automatic Wi-Fi connection to the ICM’s wireless network.



## Email Best Practices

There are several ways to reduce the amount of data your email application uses. Consider the following email best practices:

- Use an IMAP (Interactive Mail Access Protocol) server instead of traditional POP3 (Post Office Protocol 3).
- Disable automatic sending/receiving of new mail.
- Send messages in plain text rather than HTML format.
- Compress all attachments.
- Disable automatic signatures and read receipts.

## CommBox Features

The optional CommBox software extends the network capabilities of the ICM to improve crew morale, streamline operations, improve efficiency, and reduce costs. Two options are available:

- **CommBox Standard Bundle** (KVH part no. 35-0010): Provides least cost routing, onboard firewall, web caching, web image compression, ad removal, and URL and content filtering
- **CommBox Enterprise Bundle** (KVH part no. 35-0011): Provides everything included in the Standard bundle, plus automated file transfers, differential synchronization, mail relay server, web mail client, anti-spam and anti-virus filters, roaming crew accounts, and prepaid Internet and email services

*NOTE: The CommBox Enterprise Bundle requires integration with a CommBox hub.*

### Purchasing a CommBox Bundle

To learn more about CommBox's powerful suite of network management features, go to the TracPhone V3-IP web interface and click the **CommBox** tab. Then contact KVH's Application Engineering Department at [appeng@kvh.com](mailto:appeng@kvh.com) for a consultation. KVH will coordinate with you to select, install, and configure the appropriate bundle to meet your needs.

### Accessing the CommBox Web Interface

If a CommBox software bundle is enabled on the ICM, follow these steps to access the CommBox web interface:

1. At the TracPhone V3-IP web interface, click the **CommBox** tab.

Figure 8-2 CommBox Tab



2. Click **Log in to CommBox Control**.
3. Log into the CommBox web interface with your CommBox user name and password.

*NOTE: The CommBox user name and password differs from the ICM's Administrator password.*

For more details about how to use the CommBox, refer to the CommBox manual available on the **Help** tab of the CommBox web interface.

Figure 8-3 CommBox Help Tab

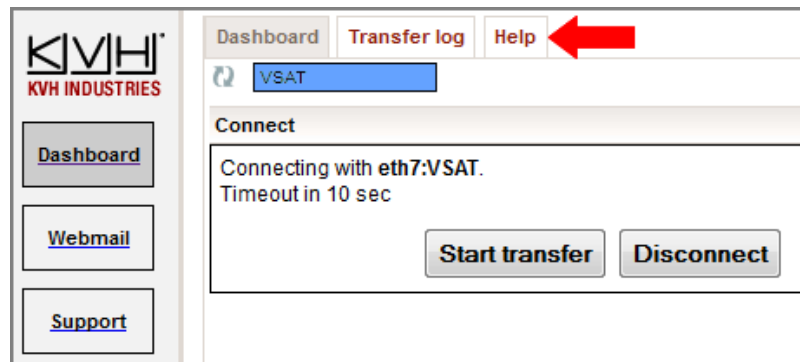

## IP-MobileCast Features

KVH's optional IP-MobileCast service delivers licensed entertainment to commercial vessels and superyachts at sea without consuming the vessel's data plan or affecting data speeds. It also offers large file delivery services for critical ship operations, including chart updates, weather data, and crew training.

When installed on the vessel, the KVH Media Server can receive licensed movies, TV shows, digital newspapers, and e-learning courses via IP-MobileCast, as it is designed to decode copyrighted content safeguarded by digital rights management (DRM). The Media Server stores all subscribed IP-MobileCast content downloaded from the mini-VSAT Broadband network and streams it locally to connected shipboard devices.

Figure 8-4 Media Server



Without a Media Server installed on the vessel, you can still receive electronic charts and weather data via the IP-MobileCast service. The ICM will store all of this content on its internal hard drive.

To learn more about IP-MobileCast, visit [www.kvh.com/ipmc](http://www.kvh.com/ipmc). You can also explore its web interface on the ICM. Connect your computer or mobile device to the vessel network that is connected to the ICM. Then start your web browser and enter <http://ipmobilecast.com>.

### Accessing the IP-MobileCast Web Interface

To access the IP-MobileCast web interface on the ICM (a Media Server is not installed), connect your computer or mobile device to the vessel network that is connected to the ICM. Then start your web browser and enter <http://ipmobilecast.com>.

If a Media Server is installed, refer to the IP-MobileCast Viewing Guide, which came with the Media Server, for access details.



# 9. Troubleshooting

This section identifies some basic problems along with their possible causes and solutions. It also explains what the error messages, status messages, and LED conditions indicate, how to view and export the system logs, and how to get support.

## Contents

Initial Steps for Any Problem .....	107
Troubleshooting a Voice Problem .....	109
Troubleshooting a Data Problem .....	111
Error and Warning Messages .....	113
Status Information .....	117
LED Indicators .....	127
System Logs .....	129
Equipment ID Numbers.....	131
Software Versions .....	132
OneCare Customer Support.....	133





## Initial Steps for Any Problem

If you are experiencing a problem with your TracPhone system, first follow these basic steps:

### Step 1a: Check System Status Information on the Web Interface

Open a web browser window on any computer on the network and enter <http://minivsat.kvh> to access the TracPhone V3-IP web interface.

*NOTE: This web address may not work on all platforms and browsers. It also will not work in certain network configurations. If the web interface does not appear, enter the ICM's IP address instead (default is 192.168.5.1). You can find this address on the ICM front panel LCD (go to Settings > Network Settings > IP Assignments).*

The Home page provides system status information. Check the following:

- **Connection Status:** "Online" indicates the system is connected to the mini-VSAT Broadband service.
- **Antenna State:** "Tracking" indicates the antenna is tracking the satellite.
- **My Phone:** "Online & Ready" indicates the ICM's built-in MTA is connected to the enhanced voice service.

If a status message differs from the normal indications listed above, refer to ["Status Information" on page 117](#). If an error message is displayed, refer to ["Error and Warning Messages" on page 113](#).

### Step 1b: Check System Status Information on the ICM Front Panel

If you are unable to connect to the web interface, you can find similar status information on the front of the ICM. Check the following:

- **ICM LCD:** "Online Tracking" indicates the system is connected to the mini-VSAT Broadband service and the antenna is tracking the satellite.
- **LEDs:** All LEDs should be lit green.

If a status message differs from the normal indication listed above, refer to ["Status Information" on page 117](#). If an error or warning message is displayed, refer to ["Error and Warning Messages" on page 113](#). If an LED is not lit green, refer to ["LED Indicators" on page 127](#).

## Step 2: Check for Blockage

If the antenna is continuously searching for the satellite, check the area around the antenna for blockage. The antenna needs an unobstructed view of the sky to receive satellite signals. Common causes of blockage include other onboard masts or structures, severe weather, and nearby buildings, bridges, trees, or other vessels.

*NOTE: You can determine which direction the antenna is pointing by viewing the Home page on the web interface or the "CURRENT AZ/EL" status message on the ICM front panel LCD (go to Status > Antenna/ACU Status > Current Az/El).*

If there is no blockage, you might be located outside of the mini-VSAT Broadband service coverage area (for a coverage map, visit [www.kvh.com/minivsatmap](http://www.kvh.com/minivsatmap)). If there is partial blockage causing intermittent antenna performance, you can set up a tracking avoidance zone to avoid tracking in that direction (see "Setting Up Tracking Avoidance Zones" on page 40).

## Step 3: Try Accessing the KVH Test Page

Try accessing the KVH test page at <http://test.minivsat.net> (*only works via mini-VSAT Broadband*). If the KVH test page appears in your browser, but you still can't access any other web page, there might be an account or hub issue – contact KVH Technical Support (see "Contacting KVH Technical Support" on page 134).

## Step 4: Check Power and Cables

Make sure power is applied to all system components. Also make sure all cables are connected tightly.

## Step 5: Restart the System

Try restarting the system at the TracPhone V3-IP web interface (see "Hardware Restart" on page 152). If you cannot access the web interface, turn off the ICM at the front panel, then turn it back on.

# Troubleshooting a Voice Problem

If you are unable to make a voice call, follow these steps:

## Step 1: Check the Basics

Complete the initial steps described in [“Initial Steps for Any Problem” on page 107](#).

## Step 2: Make Sure You Are Dialing the Number Properly

As explained in [“Making a Ship-to-Shore Call” on page 50](#), if you are dialing a number outside the country assigned to Line 1, you need to dial the appropriate international prefix and country code, in addition to the area/city code and local phone number. For example, if your Line 1 is assigned a United States phone number and you are calling a number outside of the U.S., you need to dial 011 + Country Code + Area Code + Local Phone Number.

## Step 3: Check the My Phone Status on the Web Interface

At the TracPhone V3-IP web interface, go to the Home page and check the My Phone status information. If it shows “Unable to Register Voice Service,” there is an account or activation issue - contact KVH Technical Support (see [“Contacting KVH Technical Support” on page 134](#)). The My Phone status also shows the status of the phone line.

## Step 4: Restart the MTA

The MTA built into the ICM might need to download an updated configuration file from the network. Try restarting the MTA at the TracPhone V3-IP web interface (see [“Hardware Restart” on page 152](#)).

## Step 5: Verify the MTA Obtained an IP Address

The MTA built into the ICM must receive an IP address from the ICM in order to provide a voice connection. Pick up the handset on any phone connected to the ICM and press \*\*\*1 on the keypad. If you hear “0.0.0.0” in the handset, the MTA did not receive a valid IP address. Contact KVH Technical Support for assistance (see [“Contacting KVH Technical Support” on page 134](#)).

**Step 6: Try a Different Phone**

Disconnect the phone from the ICM and connect another phone in its place (use a phone that you know is working properly). If you are then able to place a call with the new phone, the phone you were using is faulty.

**Step 7: Verify the Phone Is Connected Properly**

Make sure your phone is connected to the RJ11 "Voice Line 1" jack on the ICM. Do not use the "Voice Line 2" jack. Only "Voice Line 1" is enabled for use.

# Troubleshooting a Data Problem

If you are unable to access the Internet, follow these steps:

## Step 1: Check the Basics

Complete the initial steps described in [“Initial Steps for Any Problem” on page 107](#).

## Step 2: Check Your Computer's DHCP Configuration

Unless you have set up a static IP address, your computer's TCP/IP settings need to be configured for DHCP addressing, which allows the ICM to assign it an IP address. Refer to [“Configuring Computers for DHCP” on page 81](#) for details.

## Step 3: Try a Direct Wired Connection

Connect your computer directly to the “User Ethernet 1” port on the back of the ICM using an Ethernet cable. Then restart your computer. If you are now able to access the Internet, there is a problem with your vessel's network.

## Step 4: Ping the Network Connections

The Ping command sends a test packet to any IP address you choose and reports how long it takes to receive a response.

### To send a Ping on a Windows PC:

Open a Command Prompt window (*press Windows Logo key + R, then type cmd*). Then, at the command prompt, type **ping <IP address>**.

### To send a Ping on a Mac:

Open the Network Utility (*go to Finder > Utilities > Network Utility*). Then, in the Ping tab, type the IP address then click **Ping**.

Ping the IP address of the ICM. You can find the IP address on the front panel LCD (*go to Settings > Network Settings > IP Assignments*). The default IP address is **192.168.5.1**. All packets sent should be received. If packets are lost, your computer is not connected properly to the ICM.

Ping **4.2.2.1** to check your connection to the Internet. All packets sent should be received within 580-900 ms. If the ping fails, contact KVH Technical Support (see [“Contacting KVH Technical Support” on page 134](#)).

Figure 9-1 Pinging the Network Connections

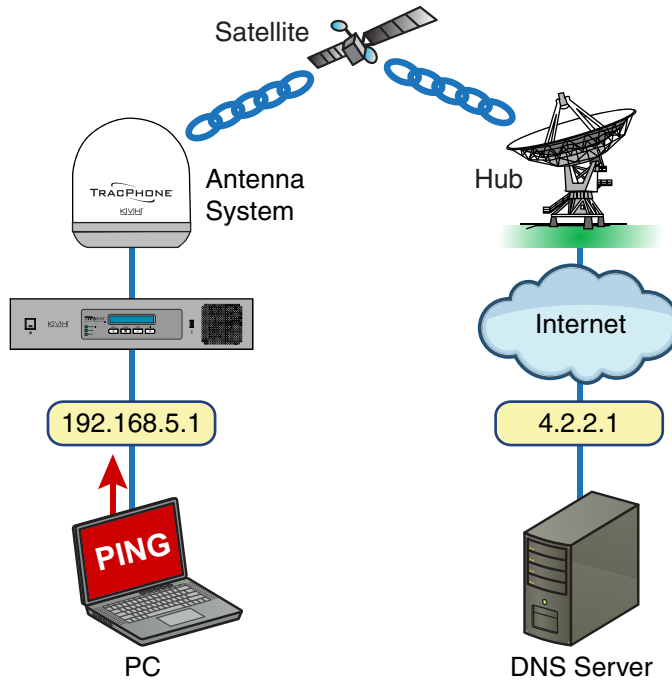

## Error and Warning Messages

This section lists the error and warning message codes that might appear on the TracPhone V3-IP web interface, front panel LCD, and/or system logs to indicate a system problem. Many of these faults should only be repaired by a KVH-certified technician; contact KVH Technical Support for assistance (see [“Contacting KVH Technical Support”](#) on page 134).

No.	Description
100	Error: There is an open circuit in the antenna power/data cable. Check the cable.
101	Error: There is a short circuit in the antenna power/data cable. Check the cable.
102	Warning: The ICM is not providing the proper DC power to the antenna. Check the wires on the back of the ICM.
103	Warning: A software update file was not found on the USB device. Try these steps: <ul style="list-style-type: none"><li>• Remove the USB device from the ICM, wait 10 seconds, then reinsert it.</li><li>• Verify that a valid TracPhone V3-IP update file (ending in “.kvh”) is present on the USB device in its root directory.</li><li>• Replace the update file on the USB device with a new file.</li><li>• Use a different USB device.</li></ul>
104	Warning: The software update file you selected is corrupt. Try a new update file.
105	Warning: The ICM is unable to read from or write to its internal memory (EEPROM). Contact KVH.
106	Error: The ICM has lost communications with the antenna. Try these steps: <ul style="list-style-type: none"><li>• Check the wiring on the back of the ICM.</li><li>• Check the antenna power/data cable.</li><li>• Try turning the system off, then back on.</li></ul>

No.	Description
107	<p>Warning: The ICM's internal temperature exceeds acceptable limits. Try these steps:</p> <ul style="list-style-type: none"> <li>• Listen for the cooling fan inside the ICM. If you don't hear the fan, contact KVH.</li> <li>• If you hear the cooling fan, turn off the system and allow it to cool down. Then vacuum the ICM's vents (see <a href="#">"Preventative Maintenance" on page 137</a>).</li> <li>• If the problem persists, you might need to relocate the unit to an area that provides better ventilation.</li> </ul>
111	<p>Warning: The ICM is unable to initialize its built-in wireless access point (WAP). Contact KVH.</p>
112	<p>Warning: There is an internal fault in the ICM. Contact KVH.</p>
117	<p>Error: There is an open circuit in the BUC power cable (ICM jumper cable between C1 and C2) or the transmit (TX) RF cable. Check the cables. If the cables are OK, the BUC might be faulty – contact KVH.</p>
118	<p>Error: There is a short circuit in the BUC power cable (ICM jumper cable between C1 and C2) or the transmit (TX) RF cable. Check the cables. If the cables are OK, the BUC might be faulty – contact KVH.</p>
120	<p>Warning: The internal temperature of the ICM's built-in modem exceeds acceptable limits. Try these steps:</p> <ul style="list-style-type: none"> <li>• Listen for the cooling fan inside the ICM. If you don't hear the fan, contact KVH.</li> <li>• If you hear the cooling fan, turn off the system and allow it to cool down. Then vacuum the ICM's vents (see <a href="#">"Preventative Maintenance" on page 137</a>).</li> <li>• If the problem persists, you might need to relocate the unit to an area that provides better ventilation.</li> </ul>
121	<p>Error: The ICM is not receiving satellite signal strength (RSSI) data from its built-in modem. Try these steps:</p> <ul style="list-style-type: none"> <li>• Turn the ICM off, then back on.</li> <li>• Check the serial data jumper cable on the back of the ICM connecting between A1 and A2.</li> </ul>
122	<p>Error: The ICM's built-in modem is not communicating. Try these steps:</p> <ul style="list-style-type: none"> <li>• Check the ICM jumper cables.</li> <li>• Try turning the ICM off, then back on.</li> <li>• If the error persists, contact KVH.</li> </ul>



No.	Description
123	Error: The ICM's built-in modem is not responding to status queries. Contact KVH.
124	Warning: The software update file you selected is not valid for the TracPhone V3-IP. Try a new update file.
127	Error: The antenna is not accepting the no-transmit zones setup from the ICM. Contact KVH.
128	Warning: The software update failed. Retry updating the software. If it fails again, check the power/data cable and the wires on the back of the ICM.
200	Warning: The antenna is not receiving adequate DC power from the ICM. Check the power/data cable and the wires on the back of the ICM.
204	Error: The antenna's main board has lost RF communications. Try updating the software (see <a href="#">"Software Updates"</a> on page 139).
206	Error: The antenna's azimuth motor or limit switch failed. Contact KVH.
208	Error: The antenna's elevation motor or limit switch failed. Contact KVH.
218	Error: The antenna's skew motor or limit switch failed. Contact KVH.
219	Error: One of the antenna's gyros is out of calibration. Try recalibrating the gyros (see <a href="#">"Gyro Calibration"</a> on page 150). If a gyro fails to calibrate, contact KVH.
220	Warning: One of the antenna's gyros failed. Contact KVH.
221	Error: The system is not receiving any GPS data. Contact KVH.
222	Warning: The antenna's internal temperature exceeds acceptable limits. Turn off the system and allow it to cool. If the problem persists, contact KVH.
234	<p>Error: The antenna is not receiving satellite signal strength (RSSI) data from the ICM. Try these steps:</p> <ul style="list-style-type: none"> <li>• Turn the ICM off, then back on.</li> <li>• Check the wires on the back of the ICM.</li> <li>• Check the power/data cable.</li> </ul>

No.	Description
235	Error: The antenna has lost RF communications. Contact KVH.
240	Error: The antenna's LNB is not receiving the proper power from the ICM's receive (RX) RF cable. Check the RX RF cable.
241	Error: The antenna's main board detects a power failure. Contact KVH.
265	Warning: The GPS is unable to acquire a fix. Check for blockage or RF interference around the antenna.
404	Warning: Antenna is unwrapping its coiled internal cable. Normal operation should resume within one minute.
410	Warning: The ICM has lost Ethernet communications with its built-in modem. Check the jumper cable connecting "B1" to "B2" on the back of the ICM.
411	Warning: The antenna cannot find an available service satellite. You are located outside the coverage area.
412	Warning: The ICM is not receiving the proper DC voltage from its power supply. Check the power cable
413	Warning: The antenna is waiting for GPS to acquire a fix.
414	Warning: The antenna is using position data from a backup GPS device and not its built-in GPS.
417	Warning: The antenna is pointing in a tracking avoidance zone. Performance might be degraded until the antenna can switch to an alternate satellite or move outside the zone.

## Status Information

You can find system status information on the TracPhone V3-IP web interface and front panel LCD. Similar information is available in both places. See the following for details:

- “[Status Information on the Web Interface](#)”
- “[Status Information on the ICM Front Panel LCD](#)” on page 123

### Status Information on the Web Interface

On the TracPhone V3-IP web interface, you can view status information on the following pages:

- Home page (see “[Home Page of the Web Interface](#)”)
- Support page (see “[Support Page of the Web Interface](#)” on page 120).

### Home Page of the Web Interface

The Home page provides basic system status information.

Figure 9-2 Home Page

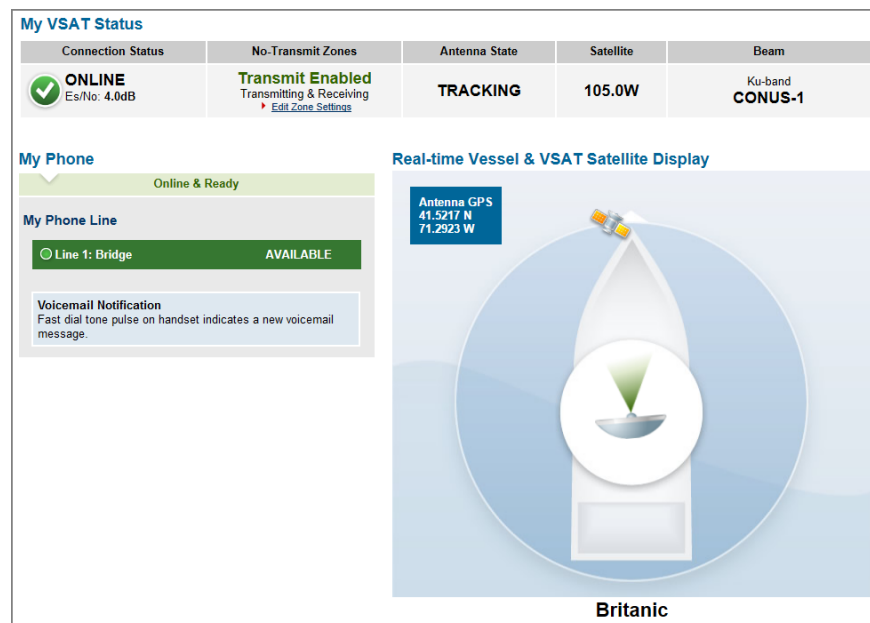

The tables below summarize the status information that is available on the Home page.

### My VSAT Status

Message	Description
Connection Status	<p>General status of the ICM's built-in modem:</p> <ul style="list-style-type: none"> <li>• Online – Modem is connected to the mini-VSAT Broadband service; the system is ready for use</li> <li>• Initializing</li> <li>• Waiting for Hub Comm – Modem is waiting for the antenna to lock onto the satellite</li> <li>• Attempting Login – Modem is attempting to log into the mini-VSAT Broadband service</li> <li>• Offline – Modem is not connected to mini-VSAT Broadband</li> <li>• Updating – Modem is downloading new software or satellite configuration files</li> </ul> <p><b>Es/No:</b> Quality of the received satellite signal; Es/No = Energy per symbol/ noise power per Hertz</p>
No-Transmit Zones <i>(if zones are set up)</i>	<p>Status of the no-transmit zones:</p> <ul style="list-style-type: none"> <li>• Transmit Enabled (green) – Antenna is not pointing within a no-transmit zone</li> <li>• Transmit Disabled (orange) – Antenna is pointing within a no-transmit zone; zones are being enforced</li> <li>• Transmit Enabled (red) – No-transmit zones are being ignored; antenna can transmit without restriction</li> </ul>
Antenna State	<p>General status of the antenna:</p> <ul style="list-style-type: none"> <li>• Tracking</li> <li>• Initializing</li> <li>• Searching</li> <li>• Cable Unwrap – Unwrapping the internal cable; the cable can wrap up to 710°</li> <li>• Waiting for Modem</li> <li>• Idle</li> <li>• Error</li> </ul>
Satellite	Satellite that the modem has currently selected for tracking
Beam	Beam of the satellite currently selected for tracking

## My Phone

Message	Description
My Phone	General status of the system's connection to the enhanced voice service: <ul style="list-style-type: none"><li>• Online &amp; Ready – the voice service is ready for use</li><li>• Offline</li><li>• Logging In...</li><li>• Unable to Connect to Voice Service – Caused by an account or activation error; also displayed during system startup</li></ul>
Line 1	General status of the phone line: <ul style="list-style-type: none"><li>• Available (green) – the phone line is ready for use</li><li>• Dialing (green)</li><li>• Off Hook (green)</li><li>• Ringing (green)</li><li>• In Use (orange) – Phone call in progress</li><li>• Unavailable (gray)</li></ul>

For details on the Real-time Vessel & VSAT Satellite Display, refer to ["Understanding the Home Page"](#) on page 19.

## Support Page of the Web Interface

The Support page provides more detailed system status information, as reported by the ICM's built-in modem.

Figure 9-3 Support Page

The screenshot displays the 'Support Help' page with the following sections:

- Support Help:** Includes 'Restart Hardware', 'Help', and 'System Logs' buttons.
- My VSAT Status:**
  - Connection Status:** ONLINE. Es/No: 3.8dB, Az: 338.3°, Skew: -0.0°, El: 31.0°.
  - No-Transmit Zones:** Transmitting & Receiving. [Edit Zone Settings](#)
  - Antenna State:** TRACKING
  - Satellite:** 105.0W
  - Beam:** Ku-band CONUS-1
  - General Statistics:**

Modem IP	10.61.24.68
KVH Support IP	10.224.0.2
Latitude	41.5214N
Longitude	71.2918W
Login State	ONLINE
Successful Logins	2
BB Messages RX	11235
Last Login	2013-02-28T13:13:57Z
Attempted Logins	0
  - RX Statistics:**

FL State	LOCKED
FLR Packets RX	351435
Dropped (CRC)	0
  - TX Statistics:**

Attenuation	17.40
Data Rate	128000 bps
IP Packets TX	22074
TX State	Enabled
Antenna State	ONLINE, TxInhibit inactive
- Event History:** Shows three alerts from Aug 14:
  - Aug 14 11:49:46 ALERT: ANTENNA TRACKING.
  - Aug 14 18:54:26 ALERT: ANTENNA SEARCHING FOR SATELLITE.
  - Aug 14 18:57:03 ALERT: ANTENNA SEARCHING FOR SATELLITE.
  - Aug 14 18:58:12 ALERT: ANTENNA TRACKING.
- System Details:**
  - Software Versions:**

Operating System	102
ICM/Antenna	8207
Modem	3614
MTA	9.15.28
CommBox	1.5.2d
  - Hardware Information:**

Antenna S/N	130100383
ICM S/N	130101379
Modem S/N	24.68
MTA MAC Address	00:10:99:12:0d:12
- Position Backup Source:**

NMEA 0183	
State	ACQUIRED
Latitude	41.5217N
Longitude	71.2920W
- KVH Technical Support:**
  - Within the Continental U.S.A.:**

Phone:	1 (866) 701-7103
E-mail:	<a href="mailto:mvbsupport@kvh.com">mvbsupport@kvh.com</a>
  - North/South America, Australia:**

Phone:	+1 401 851-3806
E-mail:	<a href="mailto:mvbsupport@kvh.com">mvbsupport@kvh.com</a>
  - Europe, Middle East, Asia, Africa:**

Phone:	+45 45 160 160
E-mail:	<a href="mailto:mvbsupport@kvh.com">mvbsupport@kvh.com</a>

The “My VSAT Status” provides the same basic status information as the Home page, with the addition of antenna pointing information: Azimuth (Az), Elevation (El), and Skew. More detailed status information is provided at the bottom of the page.

The tables below summarize the detailed status information that is available on the Support page.

**General Statistics**

Message	Description
Modem IP	The built-in modem's external satellite IP address: 10.61.xxx.xxx; its identity on the mini-VSAT Broadband network
KVH Support IP	This field does not apply to the TracPhone V3-IP
Latitude	Vessel latitude reported by the GPS
Longitude	Vessel longitude reported by the GPS
Login State	Status of the network login: <ul style="list-style-type: none"> <li>• Online – Logged into the network</li> <li>• Offline – Logged out of the network; no user traffic will pass</li> <li>• Waiting – Attempting to log in; waiting for hub reply</li> </ul>
Successful Logins	Number of times the built-in modem has logged into the network since the last restart
BB Messages RX	Number of bulletin board messages received from the hub since the last restart; should continuously increment while logged in
Last Login	Date/time of the last successful login to the network
Attempted Logins	Number of times the built-in modem has attempted to log into the network since the last restart

**RX Statistics**

Message	Description
FL State	State of the forward link; should be "Locked" while the modem is logged in
FLR Packets RX	Number of data packets received; should continuously increment while logged in
Dropped (CRC)	Dropped data packets due to errors; should not increment in large numbers

### TX Statistics

Message	Description
Attenuation	Set by the hub; the lower the number, the higher your antenna's transmission power; typically between 5-31 dB
Data Rate	Rate at which the built-in modem is capable of transmitting data; does not indicate the actual data rate supported by your service plan
IP Packets TX	Number of data packets transmitted by the modem
TX State	Should be "Enabled" while tracking the satellite, "Disabled" when pointing within a configured no-transmit zone
Antenna State	Status of the antenna: <ul style="list-style-type: none"> <li>• OFFLINE, TxInhibit active – Antenna is not communicating with the ICM's built-in modem</li> <li>• SIGNAL ACQUISITION, TxInhibit active – Antenna is searching for the satellite</li> <li>• ONLINE, TxInhibit active – Antenna is tracking the satellite, but inhibited from transmitting due to either a no-transmit zone or location in a restricted area</li> <li>• ONLINE, TxInhibit inactive – Antenna is tracking the satellite and allowed to transmit</li> </ul>

### Position Backup Source

Message	Description
State	State of the backup GPS: <ul style="list-style-type: none"> <li>• ACQUIRED – Connected, has a valid fix</li> <li>• ACQUIRING – Connected, does not have a valid fix</li> <li>• NOT CONNECTED</li> </ul>
Latitude/ Longitude	Latitude and longitude reported by the backup GPS, if connected with a valid fix

You can view additional information on the modem's web page. Click the **Click here for more details** link to access it.



## Status Information on the ICM Front Panel LCD

On the front panel of the ICM, you can view much of the same status information that's available on the web interface.

To view the status information, follow these steps:

1. Press **MENUS** on the ICM's front panel to bring up the Status menu.
2. Press **ACCEPT** to access the status menu. Then use the **MENUS** and **ACCEPT** buttons to scroll through the submenus.

Figure 9-4 Status Menu on ICM Front Panel

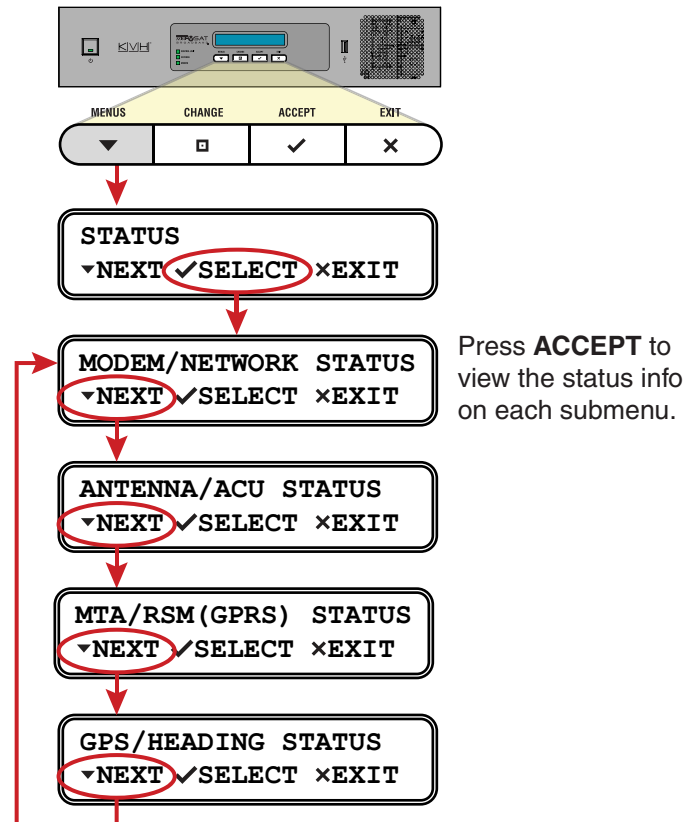

### Modem/Network Status

Message	Description
<b>MODEM SATELLITE IP</b>	External IP address of the ICM's built-in modem; identity of the modem on the mini-VSAT Broadband network (10.61.xxx.xxx)
<b>MODEM STATE</b>	General status of the modem; "Online" indicates the modem is connected to the mini-VSAT Broadband service
<b>LAN PORT STATUS</b>	Status of the Ethernet local area network (LAN); "Link Up" indicates a good connection
<b>ES/NO</b>	Quality of the received signal; Es/No = Energy per symbol/noise power per Hertz
<b>SATELLITE</b>	Satellite currently selected for mini-VSAT Broadband service
<b>BEAM</b>	Beam of the satellite currently selected for mini-VSAT Broadband service
<b>DOWNLINK FREQUENCY</b>	Frequency of the satellite downlink
<b>SKEW TO SATELLITE</b>	Skew angle of the antenna's LNB that is required to receive signals from the current satellite

### Antenna/ACU Status

Message	Description
<b>ANTENNA STATE</b>	General status of the antenna; must be "Tracking" to connect to mini-VSAT Broadband
<b>ANTENNA DC INPUT</b>	DC voltage measured at the antenna's circuit board; should be between 38 VDC and 44 VDC
<b>BUC POWER STATUS</b>	Status of the antenna's BUC (transmit) power; should be between 22 VDC and 26 VDC
<b>CURRENT AZ/EL</b>	Azimuth and elevation at which the antenna is currently pointing; azimuth is relative to the antenna's "Forward" arrow (bow)
<b>CURRENT SKEW</b>	Current skew angle of the antenna's LNB
<b>IPACU DC INPUT</b>	DC voltage measured at the ICM's power input; should be between 23 VDC and 25 VDC
<b>IPACU ENET MODEM PORT STATE</b>	Status of the ICM's Ethernet connection to its built-in modem; "Link" indicates the jumper cable is connected between B1 and B2 on the ICM's rear panel

### MTA/RSM(GPRS) Status

Message	Description
<b>MTA STATUS</b>	Status of the ICM's built-in MTA; "Registered" indicates the MTA is connected to the voice service
<b>RSM (GPRS) STATUS</b>	This message does not apply to the TracPhone V3-IP

**GPS/Heading Status**

<b>Message</b>	<b>Description</b>
<b>CURRENT GPS SOURCE</b>	Source of the GPS data used by the system
<b>SYSTEM GPS STATUS</b>	Status of the GPS currently being used by the antenna; displays vessel latitude/longitude if GPS has a valid fix
<b>NMEA TRUE HEADING</b>	This message does not apply to the TracPhone V3-IP

## LED Indicators

Status lights on the front of the ICM indicate the current status of the system and can help you identify problems quickly.

Figure 9-5 Status Lights

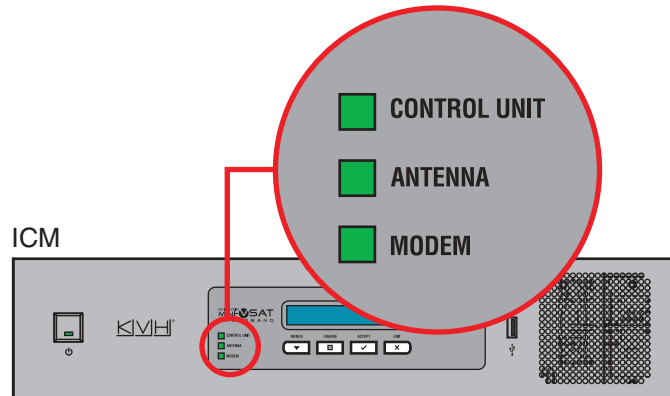

During normal operation, all status lights should be lit green. The following tables explain what the different light conditions indicate.

### CONTROL UNIT Light

The table below explains what the CONTROL UNIT light indicates.

Light is...	Indicates	Description
Off	Off	ICM is powered off or no power input
Green	OK	Good input power; ICM is operational
Green, flashing	Initializing	System is starting up
Orange	Warning	Check front panel LCD or web interface for warning message (see <a href="#">“Error and Warning Messages”</a> on page 113 for details)
Red	Error	Check front panel LCD or web interface for error message (see <a href="#">“Error and Warning Messages”</a> on page 113 for details)

### ANTENNA Light

The table below explains what the ANTENNA light indicates.

Light is...	Indicates	Description
Off	Off	No power input to the antenna
Green	Tracking	Antenna is tracking a satellite
Green, flashing	Searching	Antenna is searching for a satellite, waiting for modem communications, or processing a software update
Orange	Warning	Check front panel LCD or web interface for warning message (see <a href="#">"Error and Warning Messages"</a> on page 113 for details)
Red	Error	Check front panel LCD or web interface for error message (see <a href="#">"Error and Warning Messages"</a> on page 113 for details)

### MODEM Light

The table below explains what the MODEM light indicates.

Light is...	Indicates	Description
Off	Off	The ICM's built-in modem is powered off
Green	Online	Modem is logged into the mini-VSAT Broadband service
Green, flashing	Initializing	Modem is communicating with the antenna, but it is not yet online
Orange	Offline	Modem has logged out of the mini-VSAT Broadband service
Red	No comms	ICM lost communications with its built-in modem; check jumper cables on ICM rear panel
Red, flashing	No internal comms	Modem is not communicating with the ICM, but wiring is OK

## System Logs

The ICM offers two logs to capture historical antenna system data:

- Operational Log (see “Operational Log”)
- Event Log (see “Event Log” on page 130)

These logs are excellent diagnostic tools, so a technician or KVH Technical Support may refer to them when troubleshooting a system problem.

### Operational Log

The Operational Log, when initiated, records all messages that the antenna system generates.

To start a new log or view the current log, follow these steps:

1. At the TracPhone V3-IP web interface, click the **Support** tab.
2. On the **System Logs** menu, click **Operational Log**.

Figure 9-6 Viewing the Operational Log

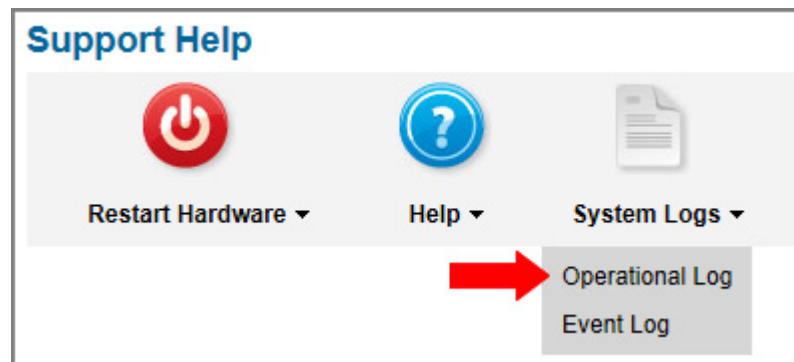

3. Click the button for your desired option:
  - **View/Save Operational Log:** This option simply opens the current Operational Log. You can save this log as a text file to send to a technician or KVH Technical Support.
  - **Start New Log:** This option deletes the current Operational Log and begins recording a new one.

- **Restart System, Start New Log:** This option deletes the current Operational Log, restarts the antenna, and begins recording a new Operational Log. This log will begin with the system's startup messages, which include the results of various self-test routines.

Figure 9-7 Operational Log Options

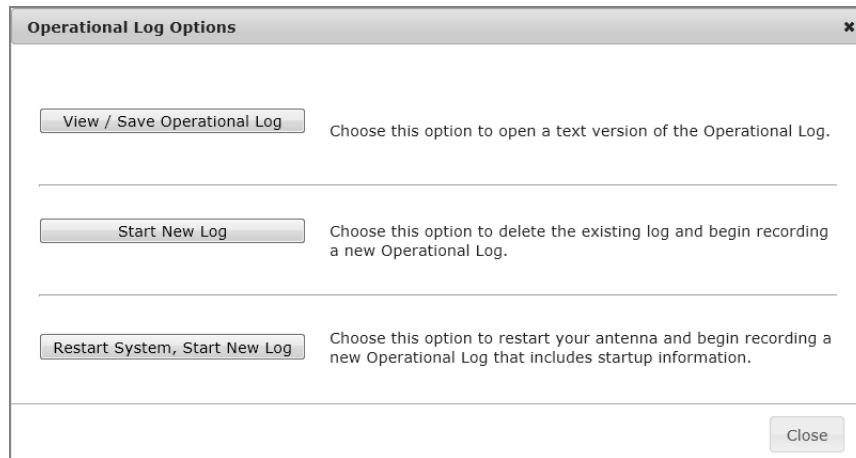

## Event Log

The Event Log keeps a historical record of the error and warning messages the antenna system generates. The most recent entries in this log are displayed on the Support page of the TracPhone V3-IP web interface.

To view the complete Event Log, follow these steps:

1. At the TracPhone V3-IP web interface, click the **Support** tab.
2. On the **System Logs** menu, click **Event Log**.

Figure 9-8 Viewing the Event Log

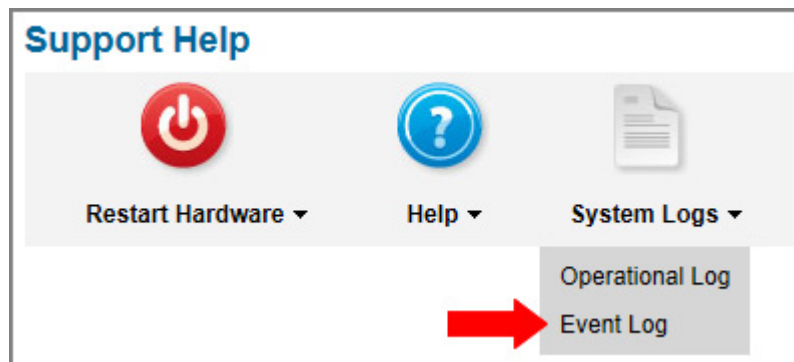



## Equipment ID Numbers

On the Support page of the TracPhone V3-IP web interface, you can find the following important equipment identification numbers:

- Antenna serial number
- ICM serial number
- Modem serial number
- MTA MAC address

*NOTE: The modem and MTA are built into the ICM.*

Figure 9-9 Viewing Equipment Identification Numbers

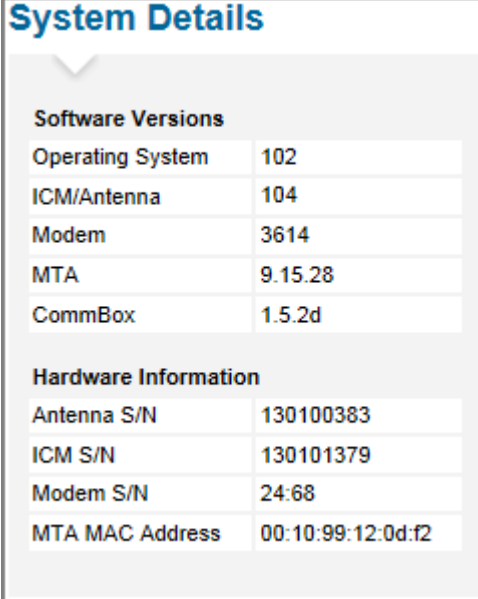

The screenshot shows a 'System Details' page with two sections: 'Software Versions' and 'Hardware Information'. Each section contains a table with two columns: the component name and its corresponding ID or version number.

Software Versions	
Operating System	102
ICM/Antenna	104
Modem	3614
MTA	9.15.28
CommBox	1.5.2d

Hardware Information	
Antenna S/N	130100383
ICM S/N	130101379
Modem S/N	24:68
MTA MAC Address	00:10:99:12:0d:f2

*NOTE: You can also view these equipment ID numbers on the front panel LCD (go to System Info > Hardware Information).*

You will need the antenna and ICM serial numbers when activating the system and whenever you contact KVH Technical Support. You will also need the modem's IP address, which is displayed on the Support page under General Statistics (see ["Support Page of the Web Interface"](#) on page 120).

## Software Versions

On the Support page of the TracPhone V3-IP web interface, you can view the currently installed versions of the following software:

- Operating system (resides on ICM)
- ICM/ Antenna – *you can update this software through the ICM (see “Software Updates” on page 139)*
- Modem
- MTA
- CommBox

Figure 9-10 Viewing the Software Versions

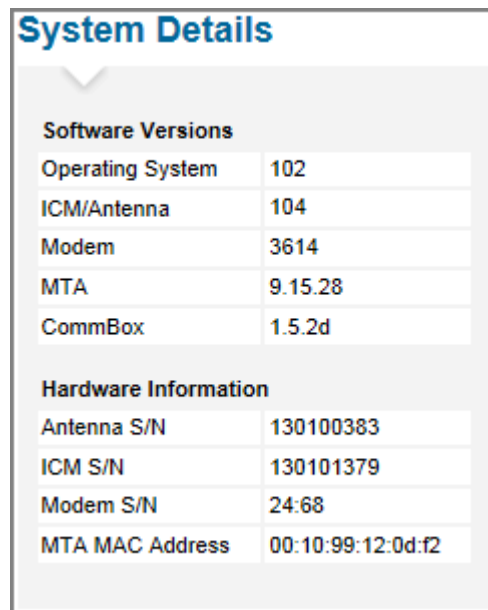

The screenshot shows a web interface titled "System Details" with a dropdown arrow. It contains two sections: "Software Versions" and "Hardware Information".

Software Versions	
Operating System	102
ICM/Antenna	104
Modem	3614
MTA	9.15.28
CommBox	1.5.2d

Hardware Information	
Antenna S/N	130100383
ICM S/N	130101379
Modem S/N	24:68
MTA MAC Address	00:10:99:12:0d:f2

*NOTE: You can also view these software versions on the ICM's front panel LCD (go to System Info > Software Versions).*

# OneCare Customer Support

KVH provides comprehensive, full life-cycle support for mini-VSAT Broadband customers as defined by the following phases:

## Application Engineering

- Sales and/or engineering assistance for solution design to address vessel or fleet operating needs

## Solution Deployment

- Installation planning, vessel preparation, service commissioning, system test, and training

## Ongoing Operating Support

- Technical assistance for service fault management and the fastest possible response should there be a problem
- Preventative maintenance for high system availability
- Extended warranties for operating cost certainty

OneCare offers coverage of KVH's complete sales portfolio, including the following:

- **KVH-manufactured products:** mini-VSAT Broadband systems
- **KVH-delivered services:** Airtime and other over-the-top services such as voice-over-IP (VoIP)
- **KVH-integrated solutions:** mini-VSAT Broadband system plus other KVH and/or other third-party equipment and services provided by KVH
- **KVH-managed land-side IT infrastructure:** Supporting software applications provided by KVH

To learn more about the OneCare services that are available to you, contact KVH Technical Support or visit [www.kvh.com/onecare](http://www.kvh.com/onecare). At KVH, we want customers to use and enjoy their service while KVH manages all the required technical and operational details.

## **Contacting KVH Technical Support**

If you experience an operating problem or require technical assistance, please contact KVH Technical Support (24x7/365):

**Within the Continental U.S.A.:**

Phone: 1 866 701-7103

Email: [mvbsupport@kvh.com](mailto:mvbsupport@kvh.com)

**North/South America, Australia:**

Phone: +1 401 851-3806

Email: [mvbsupport@kvh.com](mailto:mvbsupport@kvh.com)

**Europe, Middle East, Asia, Africa:**

Phone: +45 45 160 180

Email: [mvbsupport@kvh.com](mailto:mvbsupport@kvh.com)

Please have your system serial numbers and software versions handy before you call (see [“Equipment ID Numbers”](#) on page 131 and [“Software Versions”](#) on page 132).

# 10. Maintenance

This section explains how to perform preventative maintenance to keep the system in tip-top shape. It also explains how to update the software and the modem's satellite configuration files, calibrate the gyros, and restart system components.

## Contents

Preventative Maintenance .....	137
Software Updates .....	139
Modem Configuration Updates .....	144
Corrective Maintenance.....	149
Gyro Calibration .....	150
Hardware Restart .....	152



## Preventative Maintenance

Your TracPhone system is likely subjected to heavy use and exposed to harsh marine environmental conditions. Therefore, like any sophisticated electronic equipment installed on the vessel, it needs to be cleaned, inspected, and updated on a regular basis to maintain its peak performance and reliable service.

### Routine Care

KVH recommends that you perform the following tasks periodically to help keep the system running smoothly.

- Vacuum the vents on the ICM. Air needs to flow through these vents to cool the electronic components and prevent overheating.

Figure 10-1 Vents on ICM

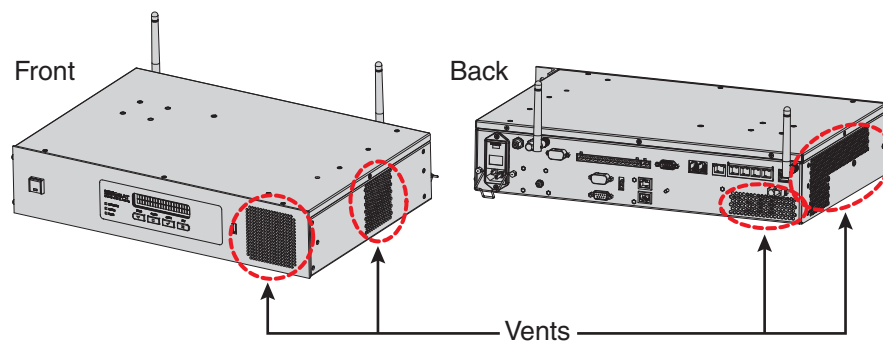

- Clean the outside of the antenna with fresh water to remove grime. Dirt buildup can affect communications. You may use mild detergent, but avoid abrasive cleansers and high-pressure water.
- Inspect cable connections at the ICM for any wear and tear. Repair any damaged cables.
- Ensure the latest software version is installed. Refer to [“Software Updates”](#) on page 139 for details.

### Annual Preventative Maintenance Check

In addition to the routine care that you do yourself, KVH recommends that you have your antenna system checked by a KVH-certified technician on an annual basis. During this service call, the technician will conduct a thorough inspection of the entire system. Some of the items on the preventative maintenance checklist include:

- Measure the input voltage and verify the system is properly grounded
- Verify that the antenna is securely and safely mounted and meets all installation best practices
- Check cables, both inside and outside the dome, for loose connections, frayed wires, corroded connectors, kinks, or other damage
- Inspect the internal antenna mechanism inside the dome, looking for any signs of wear and tear or potential points of failure
- Check all motors, belts, and limit switches and verify antenna has full range of motion
- Update the system software to the currently released version, ensuring the system has all of the latest features and enhancements
- Test the system for proper operation and capture antenna diagnostics information

To schedule a preventative maintenance check, contact KVH Technical Support (see [“Contacting KVH Technical Support”](#) on page 134).

*NOTE: If you are subscribed to a KVH OneCare Technical Assistance Package, KVH will contact you every year when it is nearing the time for your next annual preventative maintenance check. At your option, you can then schedule the check at a convenient time for your vessel.*

## Software Updates

KVH periodically releases new versions of software to enhance the performance and capabilities of the system. You can update your system to this latest software at any time by downloading the file from KVH's Update server and uploading it to the ICM. When you update the software, the new version simply overwrites the previously installed version.

A single software package includes updates to all system components in the antenna and ICM, with the exception of the modem. Modem updates are downloaded automatically via the satellite connection. When a modem update is in progress, the TracPhone V3-IP web interface shows "Updating" under Connection Status, and the ICM front panel display shows "Do not power down - Updating" for 30 minutes.

There are several methods to choose from to update the software:

- ["Using the ICM to Update Software" on page 140](#)
- ["Using Your Computer to Update Software" on page 141](#)
- ["Using an iPhone/iPod touch to Update Software" on page 142](#)
- ["Using a USB Flash Drive to Update Software" on page 143](#)



## Using the ICM to Update Software

*NOTE: This method requires Internet access; airtime charges may apply.*

To update the software using the ICM and your mini-VSAT Broadband connection, follow these steps:

1. At the TracPhone V3-IP web interface, click the **Updates** tab.
2. Under Software Update Status, click **Check Now**.
3. If the ICM is able to connect to KVH's Updates server, it notifies you whether a new version is available for download. If there is, click **Download and Install** to download the update file and install it in your system.

Figure 10-2 Updating Software Using the ICM

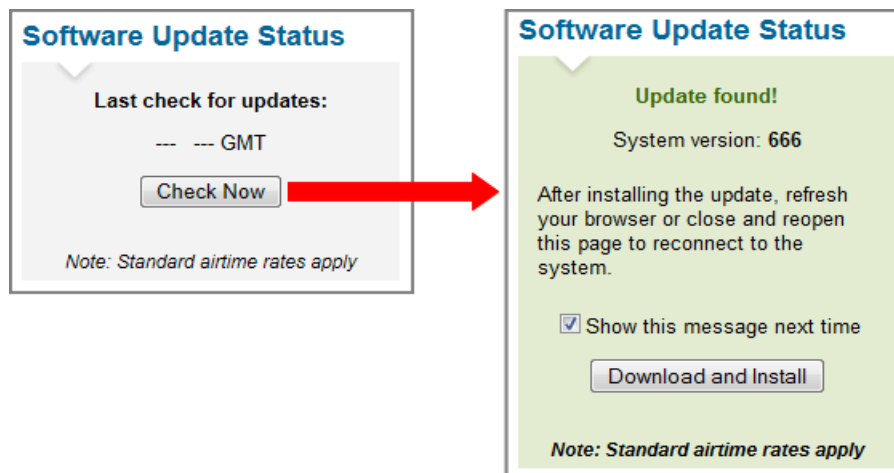

## Using Your Computer to Update Software

To update the software using your local computer, follow these steps:

1. First, you need to save the latest software update file to your computer. KVH-certified technicians can download this file from the KVH Partner Portal. Customers can get this file from KVH Technical Support (see [“Contacting KVH Technical Support” on page 134](#)).
2. Connect your computer to the ICM's network.
3. At the TracPhone V3-IP web interface, click the **Updates** tab.
4. If a Choose File button appears under Update Using this Computer, click **Choose File** then log in with the Administrator password.
5. Under Update Using this Computer, click **Browse**.
6. Navigate to and select the update file (it has a .kvh extension) saved on your computer.
7. Click **Check File**.
8. At the confirmation message, click **Update**.

Figure 10-3 Updating Software Using Your Computer

**Update Using this Computer**

To update the system's software using a file located on this computer, click **Browse** to locate the file. Then click **Check File**.

Software Update File:

V73-088.kvh  [Remove File](#)

## Using an iPhone/iPod touch to Update Software

To update the software using an iPhone/iPod touch, follow these steps:

1. If you haven't already done so, download the mini-VSAT app from the Apple iTunes® App Store.
2. Use the iPhone/iPod touch app to download the latest software version to your iPhone/iPod touch at any time.
3. Make sure the TracPhone system is turned on and initialized (the ICM front panel LCD shows "Searching" or "Tracking").
4. Connect your iPhone/iPod touch to the TracPhone system via its wireless connection, then use the app to install the software.

Figure 10-4 Updating Software Using the iPhone/iPod touch App



## Using a USB Flash Drive to Update Software

To update the software using a USB flash drive, follow these steps:

1. First, you need to save the latest software update file to the root directory of your USB flash drive. KVH-certified technicians can download this file from the KVH Partner Portal. Customers can get this file from KVH Technical Support (see [“Contacting KVH Technical Support”](#) on page 134).
2. Make sure the TracPhone system is turned on and initialized (the ICM front panel LCD shows “Searching” or “Tracking”).
3. Connect your USB flash drive to the USB port on the front of the ICM.
4. The ICM display shows the currently installed software version (“CUR”) and the software version found on the USB flash drive (“NEW”). Make sure the “NEW” version is a higher number than the “CUR” version.
5. At “PROCEED WITH UPDATE?,” press **ACCEPT**.

Figure 10-5 Software Update Process on ICM Front Panel

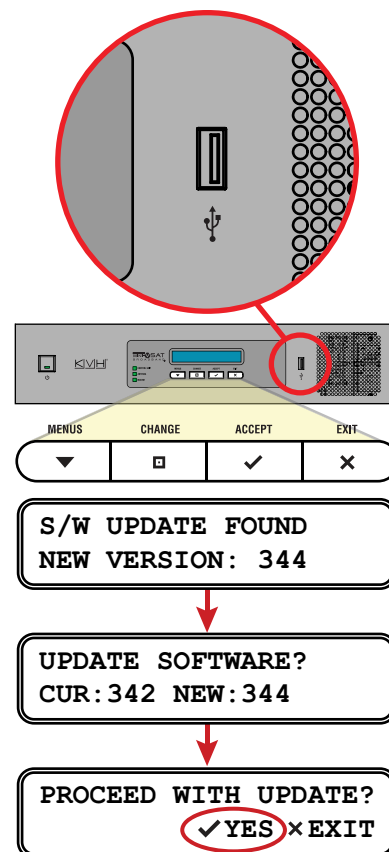

## Modem Configuration Updates

The SSCF and SED configuration files stored in the ICM's built-in modem contain all of the satellite parameters the TracPhone system needs to find and track the mini-VSAT Broadband satellites. These configuration files need to be updated whenever changes are made to the satellite network. In most cases, the modem will download the latest files automatically via the satellite link. When a download is in progress, the TracPhone V3-IP web interface shows "Updating" under Connection Status, and the ICM front panel display shows "Do not power down - Updating" for 30 minutes.

However, if your system does not operate within the mini-VSAT Broadband coverage area during the download period (several weeks), your modem might miss the update. In such cases, the modem needs to be updated manually (see ["Manually Updating the Modem Configuration Files"](#) on page 145).

Figure 10-6 Modem Update Options

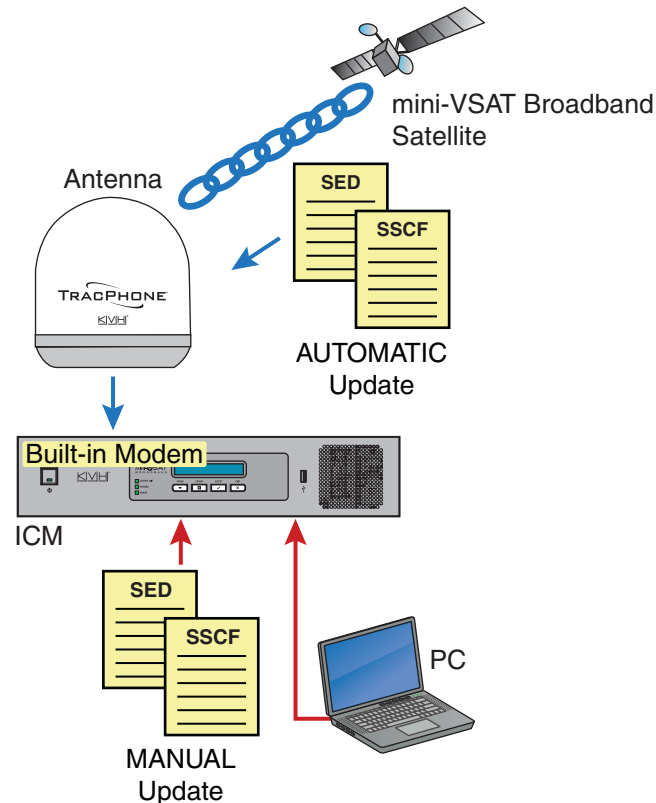

## Manually Updating the Modem Configuration Files

If your ICM's modem misses an update, you can manually update its configuration files.

### Important!

Update the modem configuration files only if directed by KVH Technical Support. Many modems have unique coverage needs that require custom configuration files.

To manually update the modem's configuration files, follow these steps:

1. First, you need to save the latest SED and SSCF modem configuration files to your computer. KVH-certified technicians can download these files from the KVH Partner Portal. Customers can get these files from KVH Technical Support (see "[Contacting KVH Technical Support](#)" on page 134).
2. Connect your computer to the ICM's network.
3. At the TracPhone V3-IP web interface, click the **Support** tab. Then click **Click here for more details** to access the modem's web page.

Figure 10-7 Link to Modem Web Page

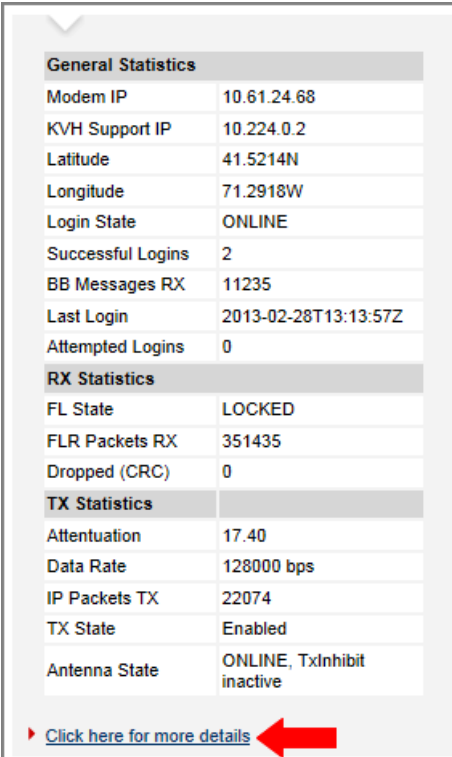

The screenshot displays a web interface with three sections of statistics: General Statistics, RX Statistics, and TX Statistics. At the bottom, there is a blue link labeled "Click here for more details" with a red arrow pointing to it.

General Statistics	
Modem IP	10.61.24.68
KVH Support IP	10.224.0.2
Latitude	41.5214N
Longitude	71.2918W
Login State	ONLINE
Successful Logins	2
BB Messages RX	11235
Last Login	2013-02-28T13:13:57Z
Attempted Logins	0
RX Statistics	
FL State	LOCKED
FLR Packets RX	351435
Dropped (CRC)	0
TX Statistics	
Attenuation	17.40
Data Rate	128000 bps
IP Packets TX	22074
TX State	Enabled
Antenna State	ONLINE, TxInhibit inactive

▶ [Click here for more details](#)

4. At the modem's web page, click the **Configuration** tab.

Figure 10-8 Modem Web Page Configuration Tab

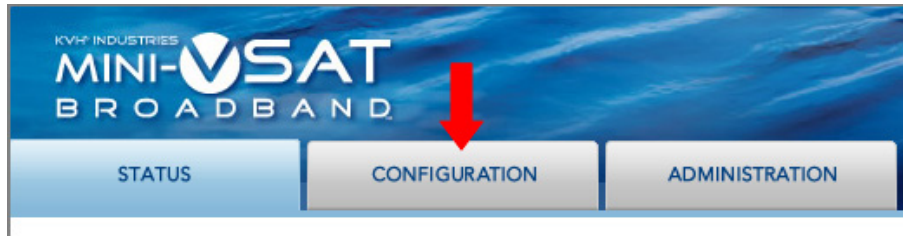

5. At the User Login page, enter the following user name and password:

User: **admin**

Password: **arclight**

6. In the sidebar, click **Satellite** (if necessary).
7. At the Satellite Configuration page, click **Browse** next to "SED file".

Figure 10-9 Uploading New Files

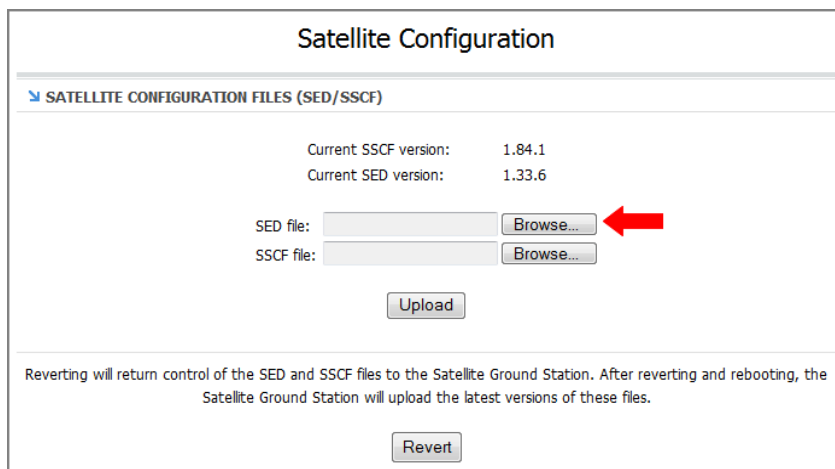

8. Browse to and select the new SED (sed.csv.agt) file on your computer.
9. Click **Browse** next to "SSCF file".
10. Browse to and select the new SSCF (sscf.csv.agt) file on your computer.

11. Click **Upload**. Make sure the new versions appear under the old versions.

12. Click **Save files**.

Figure 10-10 Saving the New Files to the Modem

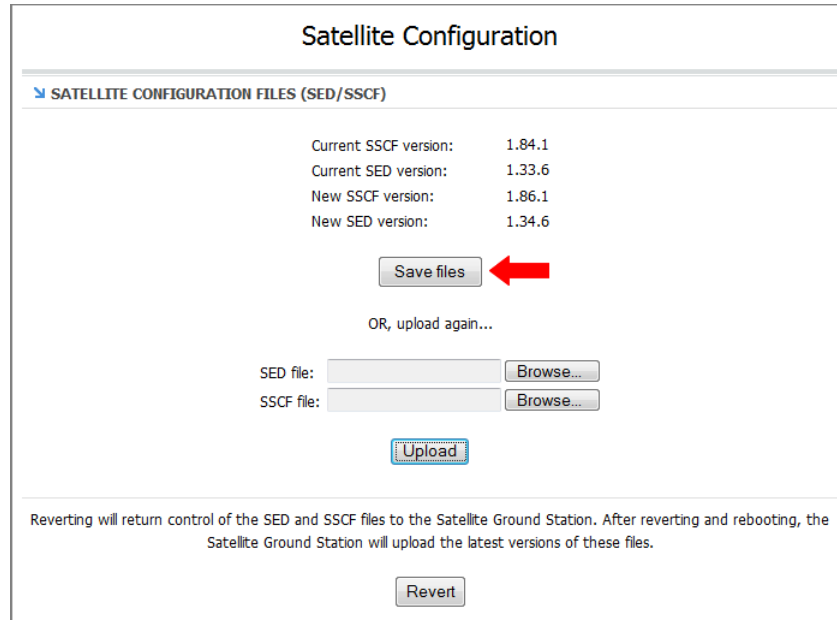

The screenshot displays the 'Satellite Configuration' interface. At the top, it says 'Satellite Configuration'. Below that is a section titled 'SATELLITE CONFIGURATION FILES (SED/SSCF)'. It lists the following information:

Current SSCF version:	1.84.1
Current SED version:	1.33.6
New SSCF version:	1.86.1
New SED version:	1.34.6

Below the table is a 'Save files' button, which is highlighted with a red arrow. Underneath the button is the text 'OR, upload again...'. There are two input fields: 'SED file:' and 'SSCF file:', each followed by a 'Browse...' button. Below these is an 'Upload' button. At the bottom of the interface, there is a paragraph of text: 'Reverting will return control of the SED and SSCF files to the Satellite Ground Station. After reverting and rebooting, the Satellite Ground Station will upload the latest versions of these files.' and a 'Revert' button.

13. When the "Files saved" message appears, click **Revert**.

---

### Important!

Be sure to revert control of SSCF and SED files to the Satellite Ground Station, allowing the modem to receive future automatic updates via the satellite link.

---



Figure 10-11 Restoring Automatic Updates

Satellite Configuration

SAATELLITE CONFIGURATION FILES (SED/SSCF)

Current SSCF version:	1.84.1
Current SED version:	1.33.6
New SSCF version:	1.86.1
New SED version:	1.34.6

Files saved.

Reboot

SED file:  Browse...

SSCF file:  Browse...

Upload

Reverting will return control of the SED and SSCF files to the Satellite Ground Station. After reverting and rebooting, the Satellite Ground Station will upload the latest versions of these files.

Revert ←

14. When the “Revert complete” message appears, click **Reboot** to restart the modem. It will now use the new configuration files.

Figure 10-12 Rebooting the Modem

Satellite Configuration

SAATELLITE CONFIGURATION FILES (SED/SSCF)

Current SSCF version:	1.84.1
Current SED version:	1.33.6
New SSCF version:	1.86.1
New SED version:	1.34.6

Files saved.

Reboot

SED file:  Browse...

SSCF file:  Browse...

Upload

Reverting will return control of the SED and SSCF files to the Satellite Ground Station. After reverting and rebooting, the Satellite Ground Station will upload the latest versions of these files.

Revert complete.

Reboot ←



## Corrective Maintenance

If a system component fails, it will need to be replaced by a KVH-certified technician. The system is a sophisticated electronic device; only specially trained KVH-certified technicians have the tools and expertise necessary to diagnose and repair a system fault.

---

### **Important!**

Field replaceable units should only be replaced by a trained, KVH-certified technician. To find a technician near you, visit [www.kvh.com/wheretogetservice](http://www.kvh.com/wheretogetservice) or contact KVH Technical Support (see “Contacting KVH Technical Support” on page 134). Instructions are provided with the replacement part.

---

## Gyro Calibration

The TracPhone antenna's gyros continuously measure the rate of vessel motion in three axes and send this data to the antenna's motor control circuitry to keep the antenna pointed at the satellite. At the factory, each gyro is precisely calibrated to work with the antenna's main board. Therefore, if you ever have a gyro or main board replaced, you will need to recalibrate.

---

### Important!

Calibrate the gyros only if directed by KVH Technical Support, and only while the vessel is stationary in calm seas. A poor gyro calibration can reduce the performance of the antenna.

---

To calibrate the gyros, follow these steps:

1. At the ICM's front panel, press **MENU** until the display shows "DIAGNOSTIC TOOLS."
2. Press **ACCEPT**.
3. At "KVH SUPPORT IP," press **NEXT**.
4. At "CALIBRATE GYROS," press **ACCEPT**.
5. At "PROCEED WITH CAL?," press **ACCEPT**.
6. Verify that the azimuth (AZ), elevation (EL), and skew gyros all pass. If a gyro fails, recalibrate. If it continues to fail, contact KVH Technical Support (see "[Contacting KVH Technical Support](#)" on page 134).
7. Once the gyros are calibrated, the antenna restarts.

Figure 10-13 Calibrating the Gyros



Press **MENUS** until  
DIAGNOSTIC TOOLS  
is displayed.

## Hardware Restart

If you experience a problem with the system, you may need to restart the hardware. You can restart the following system components from the TracPhone V3-IP web interface:

- **Restart Antenna** – Restarts the TracPhone V3-IP antenna. Choose this option whenever the antenna is unable to find the satellite.
- **Restart MTA** – Restarts the MTA (multimedia terminal adapter), which is built into the ICM. Choose this option whenever voice calls are not working properly while the system is online.
- **Restart All** – Restarts the entire system, with the exception of the built-in modem. Choose this option if the problem cannot be isolated to an antenna or MTA issue.

*NOTE: You cannot restart the built-in modem from the web interface. If you suspect the modem is locked up, try turning off the ICM at the front panel, then turning it back on.*

To restart a system component, follow these steps:

1. At the TracPhone V3-IP web interface, click the **Support** tab.
2. On the **Restart Hardware** menu, click the desired option.

Figure 10-14 Restart Hardware Menu

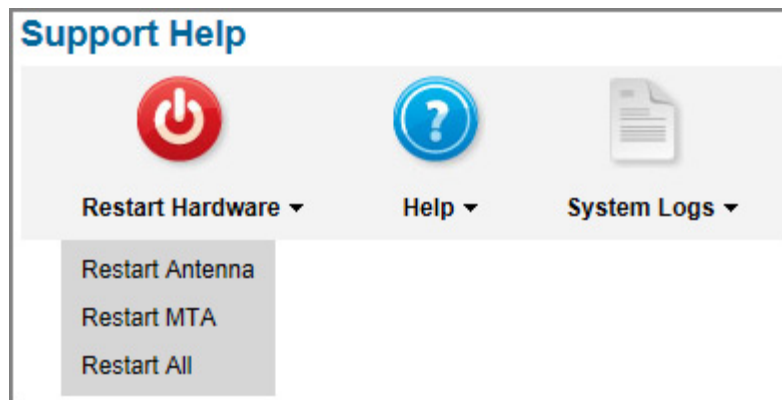

3. At the confirmation message, click **Restart Antenna**, **Restart MTA**, or **Restart ALL**.



# Appendix

## A. Wiring Diagram

This section provides a system wiring diagram. For detailed installation instructions, refer to the Installation Guide.

### Contents

Wiring Diagram.....	155
---------------------	-----



# Wiring Diagram

The wiring diagram below shows the basic system connections. For detailed installation instructions, refer to the Installation Guide.

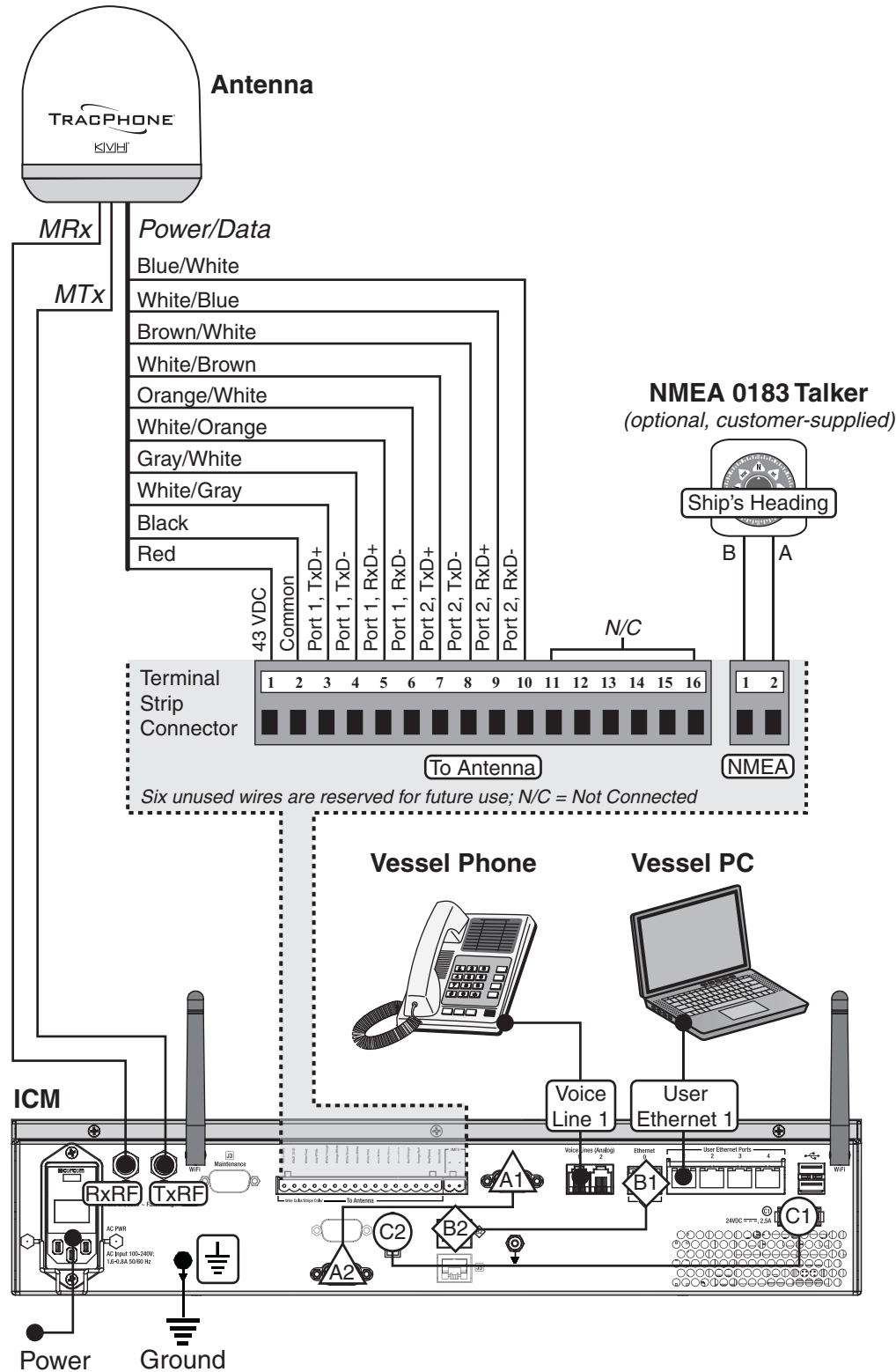



# Appendix

## B. LCD Menus

This section provides a quick reference guide to the LCD menus on the ICM's front panel.

### Contents

LCD Menu Quick Reference Guide ..... 159





# LCD Menu Quick Reference Guide

The chart below shows the menu structure of the ICM front panel LCD interface.

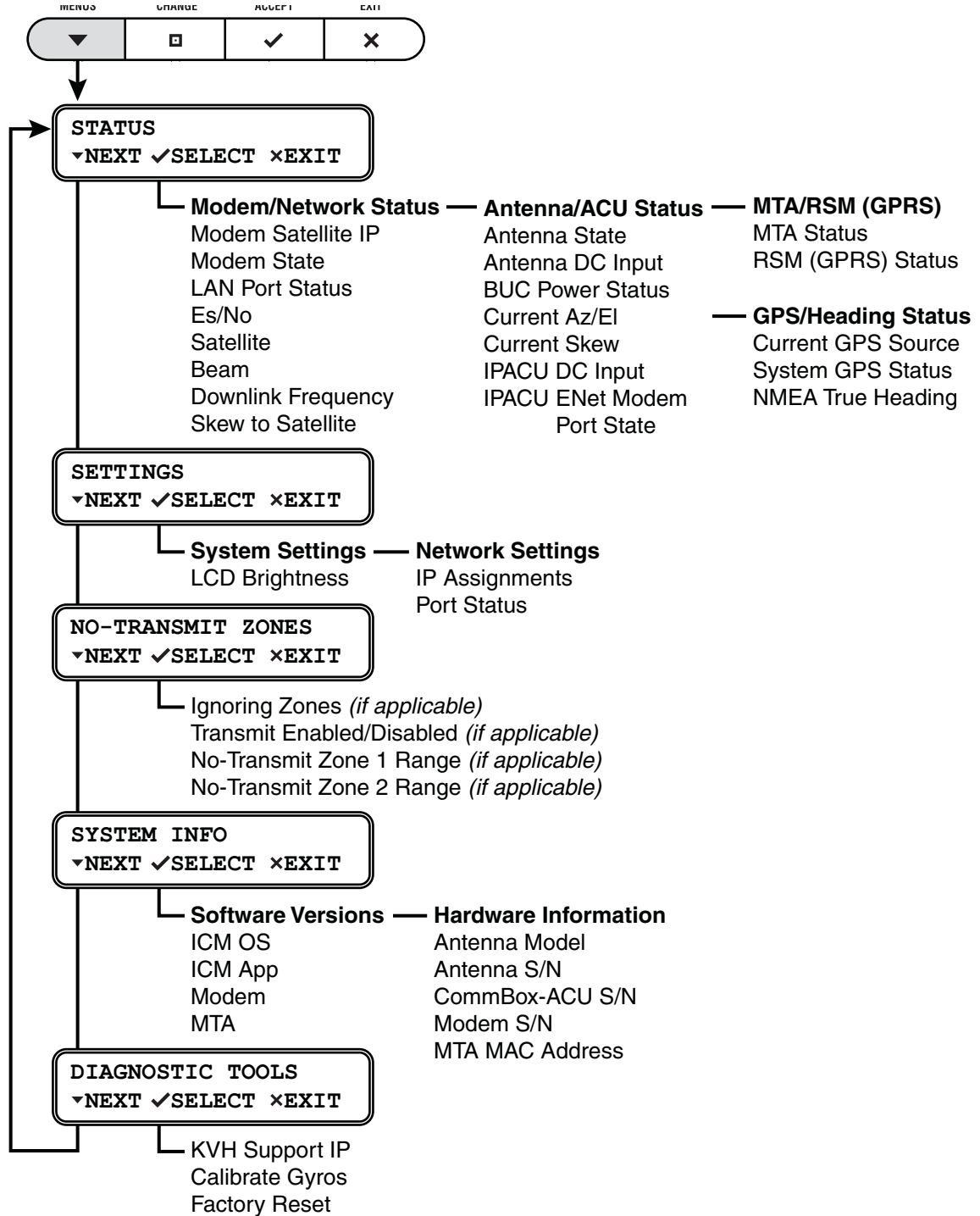



# Appendix

## C. Specifications

This section provides the technical specifications of the TracPhone system's components.

### Contents

System Specifications .....	163
-----------------------------	-----

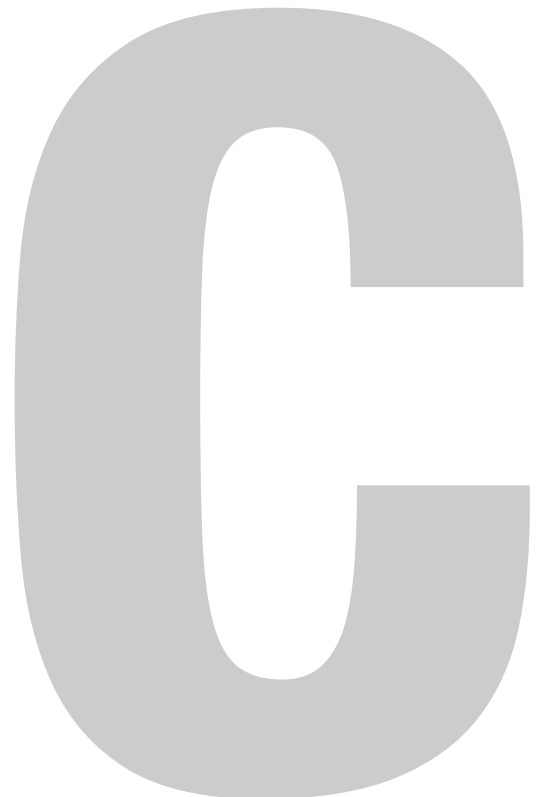

## System Specifications

### Antenna Specifications

Attribute	Rating
Meets Inmarsat operational, survival, and shock specifications	
RX receive/TX transmit frequency band	11.7-12.75 GHz/14.0-14.5 GHz
Antenna gain	31.0 dBi (RX-band, min)
Transmit power (BUC)	3 W max
Elevation range	7.5° to 75°
Azimuth range	720° rotation
Satellite coverage	See <a href="http://www.kvh.com/minivsatmap">www.kvh.com/minivsatmap</a>
Temperature	Operational: -13° F to +131° F (-25° C to +55° C) Survival: -31° F to +158° F (-35° C to +70° C)
Humidity	IEC 60945; 104° F (40° C), 95% humidity (non-condensing)
Rain	Precipitation rate of 100L/min, with wind speeds up to 100 knots
Vibration	IEC 60945
Outside dimensions	15.5" (39.4 cm) OD x 17.6" (44.7 cm) H
Weight	25 lbs (11.3 kg)

\* Specifications are subject to change without notice.

**ICM Specifications**

Attribute	Rating
NMEA input (optional)	NMEA 0183, 4800 baud, accurate within 2°, compatible sentences: <i>Heading</i> : \$--HDG, \$--HDM, \$--HDT, \$--OSD, \$--THS, \$--VHW, <i>GPS</i> : \$--RMC
Temperature	Operational: 5° F to 131° F (-15° C to 55° C) Survival: 5° F to 158° F (-15° C to +70° C)
Humidity	IEC 60945; 104° F (40° C), 95% humidity (non-condensing)
Interfaces	User Ethernet: RJ45, IEEE 802.3, 10BASE-T/100BASE-TX, 100 Mbps Wireless access point: 802.11b, 802.11g, 802.11n USB (Front Panel): USB 2.0 (for software updates only) USB (Rear Panel): Not Used Voice line: RJ11 (2-wire) analog
Dimensions	16.75" (42.55 cm) W x 11.17" (28.37 cm) D without strain-relief bracket, 16.31" (41.43 cm) D with strain-relief bracket x 3.49" (8.85 cm) H (2U)
Weight	11.25 lbs (5.1 kg)

\* Specifications are subject to change without notice.



# Appendix

## D. Glossary

This section provides a glossary of technical terms used throughout the documentation.

### Contents

Glossary.....	167
---------------	-----



## Glossary

### **10BaseT**

Ethernet standard using twisted pair cabling (such as CAT5). Supports a maximum data rate of 10 Mbps.

### **100BaseT**

Fast Ethernet standard using twisted pair cabling (such as CAT5). Supports a maximum data rate of 100 Mbps.

### **802.11**

Wireless network communications standard commonly used in LANs.

### **ACU**

Antenna Control Unit.

### **AGC**

Automatic Gain Control. Function that automatically boosts the gain of a received signal, as required, to maintain a constant output level. Indicates RF level.

### **Analog Phone**

Standard telephone, also referred to as POTS (Plain Old Telephone Service). Voice signals are converted into electrical pulses by modulating a carrier signal.

### **AZ**

Azimuth angle. Horizontal direction in which the antenna points.

### **bps**

Bits per second.

### **BUC**

Block Up-Converter. Device that converts the intermediate frequency signal from the modem to a Ku-band frequency and amplifies it for transmission.

### **Bulletin Board**

Communications from the hub to all terminals within its network.

## **Cache**

A web browser's local storage of visited web pages and other Internet files, allowing that information to be accessed more quickly on subsequent visits.

## **CAT5**

Category of twisted pair cable with a maximum data rate of 1,000 Mbps.

## **Channel**

Frequency (between 2.4-2.5 GHz) used for Wi-Fi communications. To communicate via a wireless connection, both router and host must be set to the same channel. There are 11 channels to choose from, allowing users to prevent interference between multiple wireless networks.

## **Chassis**

The outside enclosure of an electronic device.

## **Client**

A computer application that accesses resources held by a server.

## **Cloud**

"The cloud" refers to the accessibility of software applications and data storage services through a web browser.

## **CRMA**

Code Reuse Multiple Access (CRMA) protocol is a variant of CDMA, which is widely used in cellular communications. Using this protocol, multiple vessels share bandwidth for ship-to-shore transmissions to the satellite. Unlike TDMA, vessels don't need to wait their turn to transmit. They can immediately transmit in bursts at the same time as other vessels and at the fastest data rate available, significantly reducing delays.

## **Crossover Cable**

Cable in which the pins are reversed from one end to the other. Used for connecting two computers back-to-back without using an Ethernet hub.

## **Data Rate**

Speed at which a communications path can transfer information, normally measured in bits per second (bps).

## **dB**

Decibel. Ratio of one power level to another.

## **DHCP**

Dynamic Host Configuration Protocol. IP protocol that allows a server to automatically assign IP addressing information to a computer or device on the network.

## **DNS**

Domain Name Service. IP service that translates domain names (such as "www.kvh.com") into IP addresses (such as "63.105.58.10").

## **Downlink**

Communication path from the satellite to the antenna.

## **DVB**

Digital Video Broadcasting project. Global standard of digital broadcasts.

## **Es/No**

Ratio of Energy-per-symbol to Noise power spectral density, indicating the general quality of a received signal.

## **EIRP**

Effective Isotropic Radiated Power, measured in dBW.

## **EL**

Elevation angle. Vertical direction in which the antenna points.

## **Encryption**

As it applies to Wi-Fi, encoding of a wireless signal to protect it from unauthorized reception.



## **Ethernet**

Network communications standard adopted by most LANs. Communicates via twisted pair cable at one of three maximum data rates: (1) Standard - 10 Mbps, (2) Fast - 100 Mbps, and (3) Gigabit - 1 Gbps (1,000 Mbps).

## **Firewall**

Security mechanism that protects a network from unauthorized access.

## **Floating Ground**

Dangerous condition in which the chassis ground of an electrical device differs from ship's ground. This difference can measure well over 100 volts, risking damage to the equipment and electric shock, potentially resulting in death. A floating ground can be prevented by ensuring proper grounding of the device to ship's ground.

## **Footprint**

Coverage area of a satellite.

## **Forward Link**

Communication path from the satellite hub to the user terminal. Another term for "Downlink."

## **Frequency**

Number of cycles per second of a radio wave, measured in Hertz (Hz).

## **GPS**

Global Positioning System. Network of satellites that allow anyone with a GPS device to accurately fix their position on Earth.

## **Gyro**

A device that precisely senses and measures motion in a single axis, such as elevation or azimuth.

## **Host**

Any computer connected to a network.

**HTTP**

HyperText Transfer Protocol. The primary protocol for the World Wide Web.

**Hub**

Earth station that links the satellite network to the terrestrial network.

**ICM**

Integrated CommBox Modem.

**IF**

Intermediate Frequency. As it applies to TracPhone V3-IP, L-band output of an LNB, or input to a BUC.

**IMAP**

Internet Message Access Protocol. Email protocol by which a client retrieves user-selected messages that are stored on a remote mail server. Messages are saved on the server until the user deletes them.

**Internet**

Global network connecting a vast number of networks and computers.

**IP Address**

Unique network identifier assigned to a single computer or device on a network. Consists of four eight-bit numbers, each between 0 and 255 (for example, "195.172.7.2").

**Kbps**

Kilobits (1,000 bits) per second.

**Ku-band**

Range of frequencies from 10.7 GHz to 18 GHz.

**LAN**

Local Area Network. A relatively small group of computers and devices linked together within close proximity to each other and usually on the same IP network.

## **L-band**

Range of frequencies from 950 MHz to 2150 MHz.

## **LNB**

Low Noise Block down-converter. Device that converts and amplifies a Ku-band satellite signal into an intermediate frequency (IF) L-band signal.

## **MAC Address**

Media Access Control Address. Unique six-byte hardware identifier assigned to every network interface card (NIC). Used in most LAN configurations to ensure the correct addressing of data to specific hosts.

## **Mbps**

Megabits (1,000,000 bits) per second.

## **Modem**

Modulator-demodulator. Translates digital signals into analog signals and vice-versa.

## **MTA**

Multimedia Terminal Adapter. Device that converts analog telephone signals into digital Voice over IP (VoIP) signals.

## **Network**

A group of computers and devices (such as printers) linked together.

## **Network Operations Center (NOC)**

Station that maintains and manages a telecommunications network.

## **NIC**

Network Interface Card. Expansion or built-in circuit card that provides a computer with network communication capabilities.

## **NMEA 0183 Talker**

Marine electronic device, such as a gyrocompass, that transmits data messages that comply with the NMEA 0183 standard. Data is transmitted serially at 4800 baud over a pair of wires (A and B).

## **Packet**

Part of a data message transmitted over a network. Also contains the address of the destination for routing purposes. (Data messages are divided into packets, sent over a network, then reassembled in the correct order at the destination.)

## **PCI**

Peripheral Component Interconnect. Bus standard that supports high-speed connections between computers and peripheral devices.

## **PCMCIA**

Personal Computer Memory Card International Association. Organization that establishes standards for PC cards, credit card-sized memory or input/output devices, primarily used in laptops.

## **Ping**

Software utility used to check a network connection. Sends a test packet to the designated address and reports how long it takes to receive a response.

## **Polarization**

Orientation of a satellite signal. Circular polarization, which has a "corkscrew" propagation path, consists of left-hand (LHCP) and right-hand (RHCP) signals. Linear polarization consists of vertical and horizontal signals offset by 90 degrees.

## **POP3**

Post Office Protocol. Email protocol by which a client retrieves all available messages from a remote mail server and saves them locally. Messages are normally deleted from the server upon download.

## **Protocol**

Standard that establishes strict rules for how data is communicated over a network.

## **Proxy**

A server that controls client access to another server.

## **PSTN**

Public Switched Telephone Network. Worldwide telephone network carrying analog voice signals.

## **Return Link**

Communication path from the antenna to the satellite. Another term for "Uplink."

## **RF**

Radio Frequency.

## **RJ45**

Registered Jack 45. Eight-wire network cable connector for LANs. Similar to a telephone jack.

## **Router**

Device that connects multiple IP networks. For each data packet it receives that is destined for another IP network, determines the best path to reach its destination.

## **RSSI**

Receive Signal Strength Indicator. Indicates the strength of the received satellite signal.

## **RX**

Receive.

## **SIP**

Session Initiation Protocol. Protocol for routing VoIP calls.

## **Skew**

Adjustment angle to orient an LNB with a linearly polarized satellite signal.

## **Spread Spectrum**

A type of communication method by which the information signal energy is spread over a frequency band much wider than the minimum bandwidth required for transmitting the information. The resulting low power level across the full bandwidth does not interfere with neighboring satellites, so the width of the transmitted beam is not as critical as it is with traditional VSAT antennas.

## **SSID**

Service Set Identifier. Unique identifier shared by all computers and devices on a single wireless network.

## **Straight-through Cable**

Cable in which the pins at one end match the pins at the other end.

## **Subnet**

Subdivision of a network based on IP address. For example, with a subnet mask of "255.255.255.0," all computers and devices assigned an IP address starting with "195.172.8" belong to one subnet (there are 255 possible). An IP address starting with "195.172.9" designates a different subnet.

## **Subnet Mask**

Divides the latter portion of an IP address into subnet and host designations. For example, in a regular class B network, the first two numbers in an IP address define the network ID while the last two numbers define the host ID (the individual computer or device on that network). A subnet mask changes the format of these last two numbers by designating the third number as the subnet ID and designating the last number as the host ID (the computer or device within that subnet).

## **SW**

Software.

## **Switch**

Device that connects two segments of a LAN. Routes data from one segment to another based on the MAC address of the destination.

## **TCP/IP**

Transmission Control Protocol/Internet Protocol. Two communications protocols for the Internet. IP handles the delivery of data packets over the Internet; TCP ensures that all data packets are successfully delivered and assembled in the proper order.

## **Transponder**

Component of a satellite that receives radio transmissions from Earth, amplifies them, and retransmits them back to Earth on a different frequency.

## **Twisted Pair**

Cable type consisting of multiple pairs of cable in which two wires are spiraled together to reduce electromagnetic noise. Can be either shielded (STP) or unshielded (UTP). Used extensively in LANs and telephone networks.

## **TX**

Transmit.

## **URL**

Uniform Resource Locator. Address of a web page or file on the World Wide Web. Consists of three parts: (1) protocol (such as "http"), (2) IP address or domain name (such as "www.kvh.com"), and (3) name of the web page or file to be retrieved from that address (such as "index.html").

## **USB**

Universal Serial Bus. Bus standard for connecting peripheral devices to a computer. Supports a data rate of 12 Mbps.

## **UTP**

Unshielded Twisted Pair. Cable consisting of four twisted pairs (8 wires), usually terminated by RJ45 connectors. Commonly used in LANs.

## **VoIP**

Voice over Internet Protocol. Allows telephone conversations to be routed via the Internet.

## **VSAT**

Very Small Aperture (< 3 m) Terminal. Communications system in which multiple users connect via satellite to a single land-based hub, which handles the routing of all network traffic.

## **WAN**

Wide Area Network. A group of computers, devices, and possibly LANs, linked together over a large geographic area.

## **WAP**

Wireless Access Point. Device that links computers wirelessly to a LAN. To communicate with the WAP, each computer needs a properly configured wireless network card.

## **WEP**

Wired Equivalent Privacy. Security mechanism for wireless networks. Encrypts data to protect it from unauthorized interception.

## **Wi-Fi**

Wireless Fidelity. Refers to an 802.11 wireless network.

## **WINS Resolution**

Windows Internet Naming Service Resolution. Organizes the names of all Windows computers in a network with their respective IP addresses. Similar function to DNS.

## **Wireless Network Card**

PCI or PCMCIA card that provides a computer with wireless access to a LAN via a WAP.

## **WPA2**

Wi-Fi Protected Access. Security mechanism for wireless networks. Encrypts data to protect it from unauthorized interception. More secure than WEP.





# Appendix

## E. Index

This section is an index to allow you to find information quickly.

### Contents

Index.....	181
------------	-----

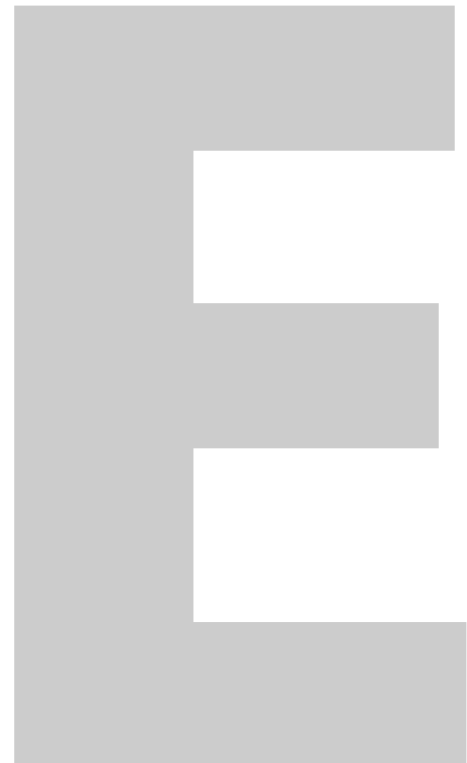

# Index

## A

- activation 15, 131
- administrator password 25
- alerts
  - data usage 89
- antenna
  - description 8
  - forward arrow 33, 40
  - pointing direction 19, 120
  - restart 152
  - serial number 131
  - software version 132
  - specifications 163
  - status 118, 122, 125
- anti-virus software 98
- applications, data-intensive 95, 100
- attenuation 122
- automatic backup and sync, disabling 98
- automatic updates, preventing 98
- azimuth 120, 125, 163
- azimuth range, no-transmit zones 33
- azimuth range, tracking avoidance zones 40

## B

- beam, satellite 118, 124
- BitTorrent 100
- blockage, satellite 10, 108
- brightness 28
- bulletin board messages 121

## C

- cache settings 88
- cache, web browser 22, 99
- calibration 150
- calls
  - ship-to-shore 50
  - shore-to-ship 52
- channel, wireless 80

- cleaning 137
- clear cache 22
- cloud services, disabling 98
- CommBox software
  - description 102
  - Help 90
  - network settings 79, 87, 88, 90
  - purchasing 102
  - version 132
  - web interface 102
- Condensed Help 21
- corrective maintenance 149
- coverage map 9
- crew configurations 70
- CRMA 7
- cumulative view, no-transmit zones 44

## D

- data allocations 73
- data rate 122
- data usage alerts 89
- data usage, reducing 97
- delay, voice call 50
- DHCP
  - Mac OS X 86
  - Windows 10 81
  - Windows 7 83
  - Windows 8 82
  - Windows Vista 83
  - Windows XP 84
- dial tone, fast 54
- dialing sequence 50
- DRM 104
- dual dome configuration 74

## E

- electric shock 5
- elevation 120, 125, 163
- elevation range, no-transmit zones 41
- e-mail, best practices 101
- emergency call 49
- End User Agreement 95, 100

equipment ID numbers 15, 131  
error messages 113  
Es/No 124  
Ethernet ports 61  
event log 130  
Extended Help 21

## **F**

fax 56  
fax server 57  
field replaceable units 149  
firewall 99  
floating ground 5  
footprint, satellite 9  
frequency 124, 163  
front panel menus 159  
FRUs 149

## **G**

gain, antenna 163  
Gnutella 100  
GPS  
    backup 122  
    position 17, 19  
    source 126  
    status 126  
gyro calibration 150  
gyro stabilization 8

## **H**

hazard, radiation 6, 16  
heading 126  
Help 21  
Help, CommBox 90  
Home page 19, 117

**I**

- ICM
  - description 8
  - LEDs 127
  - serial number 131
  - software version 132
  - specifications 164
  - status 125
- IMAP 101
- incoming calls 52
- in-country call 50
- international call 50
- Internet access 95
- IP address
  - ICM 62, 87
  - KVH support 121
  - modem 121, 124
  - MTA 109
- IP packet counters 122
- iPhone/iPod touch app 142
- IP-MobileCast 78, 104

**L**

- LAN settings 87
- latitude 121
- LCD brightness 28
- LCD menus 159
- LEDs 127
- legacy configuration 77
- lights, front panel 127
- log
  - event 130
  - operational 129
- login
  - CommBox software 102
  - crew 96
  - modem web page 146
  - voice account 58
- login counters 121
- longitude 121

## M

- maintenance
  - corrective 149
  - preventative 137
- map, coverage 9
- Media Server 78, 104
- menus, LCD 159
- mini-VSAT Broadband 7, 15
- mobile websites 100
- modem
  - configuration update 144
  - description 8
  - initialization 17
  - IP address 121, 124
  - login 146
  - restart 152
  - satellite selection 11
  - serial number 131
  - software update 139
  - software version 132
  - status 121, 124
  - web page 122
- MTA
  - IP address 109
  - MAC address 131
  - restart 109, 152
  - software version 132
  - status 119
- multimedia, disable 99
- myKVH 20, 73, 89

## N

- network
  - reset to factory 91
  - settings 87
  - status 124
  - Wi-Fi 79
- network configurations
  - crew 70
  - dual dome 74
  - legacy 77
  - selection 61
  - standard 64
  - static IP 66
- Network Operations Center 7

- NMEA 0183 126
- no-transmit zones
  - clear 36
  - cumulative view 44
  - description 31
  - disable 35
  - range 17, 33, 41
  - setup 33
  - status 32, 118

## **O**

- OneCare 133, 138
- online 17
- operational log 129
- outgoing calls 50

## **P**

- passphrase, WEP 80
- password
  - administrator 25
  - WPA2 80
- peer-to-peer file sharing 100
- phone line name 27
- ping 111
- pointing direction, antenna 19, 120
- POP3 101
- pop-up blocker 99
- power
  - antenna 125
  - BUC 125
  - ICM 125
  - transmission (BUC) 163
- power on system 16
- preloading web pages, disabling 99
- preventative maintenance 137
- priority, voice traffic 49
- Product Activation department 15
- PSTN 49

## R

- radiation hazard 6, 16
- Real-time Vessel & VSAT Satellite Display 19
- remote diagnostics 134
- remote monitoring 66
- reset, factory settings 91
- restart hardware 152
- RSS feeds 100

## S

- safety 5
- satellite 7, 118, 124
- Satellite Airtime department 15
- satellite switching 11
- secure VPN 66
- security, wireless 80
- SED 144
- serial numbers 15, 131, 134
- SIP 49
- skew 120, 124, 125
- Skype 100
- social media 100
- software update
  - description 139
  - via iPhone/iPod touch 142
  - via local computer 141
  - via satellite 140
  - via USB flash drive 143
- software versions 132
- specifications 163
- spread spectrum 7, 8
- spyware 98
- SSCF 144
- SSID 80
- standard configuration 64
- startup sequence 17
- static IP 66
- status information 117
- switch satellites 11



**T**

- technical support 134
- test web page 108
- tracking avoidance zones
  - allowance period 39
  - clear 46
  - description 39
  - disable 45
  - range 40
  - setup 40
- troubleshooting
  - basic 107
  - data problem 111
  - voice problem 109
- turn on system 16

**U**

- UCH-250 57
- USB flash drive 143
- user login 96

**V**

- vessel name 26
- virtual numbers 53
- voice service
  - account access 58
  - delays 50
  - description 49
  - fax 56
  - priority 49
  - ship-to-shore calls 50
  - shore-to-ship calls 52
  - status 119
  - virtual numbers 53
  - voicemail 54
- voicemail 54
- VoIP 49
- VPN, secure 66



## **W**

- WAP 8, 61
- warnings 5
- web browser settings 99
- web interface access 18
- widgets 100
- Wi-Fi 61, 79
- Wi-Fi access, mobile devices 100
- wiring 155



[www.kvh.com](http://www.kvh.com)



---

**KVH Industries A/S**  
*EMEA Headquarters*  
Kokkedal, Denmark  
Tel: +45 45 160 180 Fax: +45 45 160 181  
E-mail: [info@emea.kvh.com](mailto:info@emea.kvh.com)

**KVH Industries, Inc.**  
*World Headquarters*  
Middletown, RI U.S.A.  
Tel: +1 401 847 3327 Fax: +1 401 849 0045  
E-mail: [info@kvh.com](mailto:info@kvh.com)

**KVH Industries Pte Ltd.**  
*Asia-Pacific Headquarters*  
Singapore  
Tel: +65 6513 0290 Fax: +65 6472 3469  
E-mail: [info@apac.kvh.com](mailto:info@apac.kvh.com)