



Hughes 9450 Series

User Guide

Document No. 3004128-0001
Revision J
5 October 2018

Copyright © 2011 - 2018 Hughes Network Systems, LLC

All rights reserved. This publication and its contents are proprietary to Hughes Network Systems, LLC. No part of this publication may be reproduced in any form or by any means without the written permission of Hughes Network Systems, LLC, 11717 Exploration Lane, Germantown, Maryland 20876.

Hughes Network Systems, LLC has made every effort to ensure the correctness and completeness of the material in this document. Hughes Network Systems, LLC shall not be liable for errors contained herein. The information in this document is subject to change without notice. Hughes Network Systems, LLC makes no warranty of any kind with regard to this material, including, but not limited to, the implied warranties of merchantability and fitness for a particular purpose.

Trademarks

Hughes and Hughes Network Systems are trademarks of Hughes Network Systems, LLC. All other trademarks are the property of their respective owners.

Contents

Understanding safety alert messages	v
Messages concerning personal injury	v
Messages concerning property damage	v
Safety symbols	vi
Introduction.....	1
Overview	1
9450 Variants	2
About this User Guide	2
Package Contents	3
Minimum System Requirements for Laptop/PC.....	3
Getting Started	4
Installing your terminal.....	4
Terminal LED functionality.....	4
Using the Hughes 9450.....	6
Auto start configuration	6
Power up and the connection to the Internet.....	7
Connecting the terminal to the computer	8
Connecting by Ethernet.....	8
Power over Ethernet (POE).....	8
Connecting by WLAN	8
WLAN Security	9
Connecting by ISDN.....	9
Connecting by RJ11	10
Coverage Map.....	11
Operation in the MEAS cutout area.....	12
Operation in the Russian Federation.....	13
Using the Web UI.....	14
Accessing the Web UI	14
Home page	16
Connections.....	19
Manage Connections.....	19
Automatic Contexts.....	20
Manage APNs	25
SMS	27
Send/Receive.....	27
Saved Drafts.....	28

Sent Messages	28
SMS Settings	29
Settings page	31
General Setup	31
IP Address/DHCP Settings	33
Nat Mode	35
NAPT Mode	35
Relay Mode	35
Port Forwarding Page	36
Wireless LAN	37
Wireless LAN Security	40
Telephony	42
Security	44
Features	46
M2M Page	48
Ping Configuration:	48
Always On Context:	48
Usage Page	49
Support Page	50
Troubleshooting	53
PDP Context Activation Errors	55
Technology Overview	56
GPS	56
Obtaining a GPS Fix	56
GPS and BGAN Registration	57
ISDN	57
Dialing and Numbering	57
PDP Context	57
Technical Specifications	59
EU Declaration of Conformity	60
FCC Compliance	61
EU RoHS-2 (Restriction of Hazardous Substances) Directive	61
EU WEEE (Waste Electrical and Electronic Equipment) Directives	61
Glossary	63

Understanding safety alert messages

Safety alert messages call attention to potential safety hazards and tell you how to avoid them. These messages are identified by the signal words DANGER, WARNING, CAUTION, or NOTICE, as illustrated below. To avoid possible property damage, personal injury, or in some cases possible death read and comply with all safety alert messages.

Messages concerning personal injury

The signal words DANGER, WARNING, and CAUTION indicate hazards that could result in personal injury or in some cases death, as explained below. Each of these signal words indicates the severity of the potential hazard.



DANGER indicates a potentially hazardous situation which, if not avoided, will result in death or serious injury



WARNING indicates a potentially hazardous situation which, if not avoided, could result in death or serious injury.



CAUTION indicates a potentially hazardous situation which, if not avoided, could result in minor or moderate injury.

Messages concerning property damage

NOTICE

NOTICE is used for messages concerning possible property damage, product damage or malfunction, data loss, or other unwanted results—but *not* personal injury.

Safety symbols

The generic safety alert symbol  calls attention to a potential personal injury hazard. It appears next to the DANGER, WARNING, and CAUTION signal words as part of the signal word label. Other symbols may appear next to DANGER, WARNING, or CAUTION to indicate a specific type of hazard (for example, fire or electric shock). If other hazard symbols are used in this document, they are identified in this section.

Additional symbols



Warning Potential Radio Frequency (RF) hazard. Where you see this alert symbol and WARNING heading, strictly follow the warning instructions to avoid injury to eyes or other personal injury.



Warning Where you see this alert symbol and WARNING heading, strictly follow the warning instructions to avoid personal injury.



Danger Electric shock hazard: Where you see this alert symbol and DANGER heading, strictly follow the warning instructions to avoid electric shock injury or death.

Warnings for Satellite Terminal



Do not stand in front of the Antenna This device emits radio frequency energy. To avoid injury, do not place head or other body parts in front of the satellite antenna when system is operational. Maintain a distance of one meter or more from the front of the Satellite Terminal antenna.



General Handle your Satellite Terminal with care. The outdoor unit is weather resistant per IEC 60529 IP56; however, do not submerge either unit. Avoid exposing your Satellite Terminal to extreme hot or cold temperatures outside the range -25°C to +55°C.

Avoid placing the Terminal close to cigarettes, open flames or any source of heat.

Changes or modifications to the Terminal not expressly approved by Hughes Network Systems could void your authority to operate this equipment.

Only use a soft damp cloth to clean the Terminal.

To avoid impaired Terminal performance, please ensure the unit's antenna is not damaged or covered with foreign material like paint or labeling.

When inserting the SIM, do not bend it or damage the contacts in any way. When connecting the interface cables, do not use excessive force.



In the vicinity of blasting work and in explosive environments Never use the Satellite Terminal where blasting work is in progress. Observe all restrictions and follow any regulations or rules. Areas with a potentially explosive environment are often, but not always, clearly marked. Do not use the Terminal while at a petrol filling station. Do not use near fuel or chemicals.



Qualified Service Do not attempt to disassemble your Satellite Terminal. The unit does not contain consumer-serviceable components. Only qualified service personnel may install or repair equipment.



Accessories Use Hughes approved accessories only. Use of non-approved accessories may result in loss of performance, damage to the Satellite Terminal, fire, electric shock or injury.



Connecting Devices Never connect incompatible devices to the Satellite Terminal. When connecting the Satellite Terminal to any other device, read the device's User Manual for detailed safety instructions.



Pacemakers The various brands and models of cardiac pacemakers available exhibit a wide range of immunity levels to radio signals. Therefore, people who wear a cardiac pacemaker and who want to use a Satellite Terminal should seek the advice of their cardiologist. If, as a pacemaker user, you are still concerned about interaction with the Satellite Terminal, we suggest you follow these guidelines:

- Maintain a distance of 20cm from the Wi-Fi antenna and your pacemaker;
- Maintain a distance of one meter from the main antenna front and sides and your pacemaker;
- Refer to your pacemaker product literature for information on your particular device.

If you have any reason to suspect that interference is taking place, turn off your Satellite Terminal immediately.



Hearing Aids Most new models of hearing aids are immune to radio frequency interference from Satellite Terminals that are more than 2 meters away. Many types of older hearing aids may be susceptible to interference, making it very difficult to use them near a Terminal. Should interference be experienced, maintain additional separation between you and the Satellite Terminal.



Electrical Storms Operation of the Satellite Terminal during electrical storms may result in severe personal injury or death. Ensure the Below Deck Equipment is properly grounded to the vehicle chassis.

Introduction

Overview

The Hughes Network Systems 9450 Broadband Satellite Terminal is your gateway to global communication. The 9450 series terminal allows you to simultaneously send and receive IP packet and circuit-switched data via Ethernet (Power over Ethernet) ports and the Integrated Services Digital Network (ISDN) interfaces over the Inmarsat BGAN satellite network.

Depending on the version, this unit offers you the following features and benefits:

- Fully autonomous tracking antenna acquires and tracks the BGAN satellite signal while on the move
- Optional antenna installation (magnetic mount) on vehicle roof
- Includes RF cable and power cable for vehicular installation
- Up to 492 Kbps data (transmit and receive) and 256 Kbps streaming IP data rate (above 45 degrees look angle) for C10 and 128Kbps streaming for C11
- Four RJ-45 Power over Ethernet (PoE) ports (except 9450L and 9450LW)
- Compressed voice calls (except 9450L and 9450LW)
- 3.1KHz audio (above 20 degrees look angle to the satellite for C10 and above 45 degrees for C11) (except 9450L and 9450LW)
- ISDN UDI/RDI data (64Kbps) (above 20 degrees look angle to the satellite for C10 and above 45 degrees for C11) (except 9450L and 9450LW)
- Multi-user capability for sharing a single unit
- Selectable Quality-of-Service (QoS)
- Full IP compatibility for Email, file transfer (FTP), browsing, VPN, etc.
- Cost-effective “always-on” access – charges only for data sent and received
- UMTS IP-based services
- FCC and CE certified
- Subscriber Identification Module (SIM) card security

With the optional mag mount installation method, the unit is easy to install and connects in minutes. It is built for use in vehicular environments.

In this document, the following names and abbreviations are used to identify the Satellite Terminal and your computer.

Term	Definition
IDU	Indoor Unit
ODU	Outdoor Unit/antenna
Terminal	Satellite Terminal
TE	Terminal Equipment (your computer)
UT	User Terminal/satellite terminal

9450 Variants

There are multiple versions of the 9450 each with different interfaces as listed in the table below. Depending on the version, certain features will not apply.

The different models use different software release versions as shown below. The upgrader protects against loading the wrong release.

9450 Model	Interfaces	Software Release
9450	4 port 100BaseT Ethernet switch with PoE 802.11b WLAN ISDN 2 RJ11 ports	5.7.x.y
9450E	4 port 100BaseT Ethernet switch with PoE ISDN 2 RJ11 ports	5.7.x.y
9450L	4 port 100BaseT Ethernet switch only	5.7.x.y or 6.7.x.y
9450LW	4 port 100BaseT Ethernet switch 802.11b/g/n WLAN	6.7.x.y

About this User Guide

This user guide contains the most up-to-date information available on this product, on the date it was generated. It is focused on the specific information needed to operate the Hughes 9450 Land Mobile User Terminal.

For information on using LaunchPad, please refer to the Inmarsat website where a copy of the 'Inmarsat LaunchPad Guide' can be downloaded:

<http://www.inmarsat.com/Support/bgan-firmware/bgan-launchpad/>

NOTICE

LaunchPad is not supported when the 9450 is in M2M mode.

Package Contents

When you unpack the Land Mobile Terminal Kit package, you will find the following:

- BGAN Land Mobile Tracking Antenna Kit
- Hughes 9450 BGAN Satellite Modem Kit

Your Service Provider will supply you with a Subscriber Identification Module (SIM) and its PIN, and Satellite Terminal configuration instructions – you will need these to access the network. Note: The SIM card may also have four (4) MSISDN numbers associated with it for various ISDN services:

- 4K Voice
- 3.1KHz Audio/Fax
- 64K UDI data
- 56K RDI data

Minimum System Requirements for Laptop/PC

These are the minimum computer system requirements for successful interface with the Satellite Terminal:

- Internet Browser: Chrome, Internet Explorer, Edge, Firefox or Safari.
- PC Support for at least one of these interfaces: Ethernet, or WLAN (802.11b or b/g).
- 100 MB of free hard disk space (if using LaunchPad).

Getting Started

This guide is the simplest and quickest way to connect to the BGAN network. If you are a first time user, you will be guided through the procedure for powering up your terminal, obtaining a GPS fix, connecting your computer to the terminal and registering with the BGAN network. You are then ready to start using voice and broadband services.

Installing your terminal

Install the Hughes 9450 terminal according to the Installation Guide supplied with the terminal for either the C10 or C11 antenna. You can also download the Installation guides and User manuals from our website at www.bgan.hughes.com . Please refer to the Installation Guides for grounding instructions.

Terminal LED functionality

The 9450 IDU has 4 LEDs with the following functions:

Power: Green when IDU is powered on. Off when IDU is powered off. This LED is integrated in the On/Off switch.

Network Registration: Green when registered and attached with Inmarsat BGAN network; Off otherwise.

GPS: Flashing Green while acquiring fix and solid Green when valid GPS fix acquired. The GPS LED turns off when the UT registers with the network and the network LED turns on.

H/W Fault: Red if HW fault detected, e.g.: IB fault, no communication to antenna or no GPS. Off otherwise.

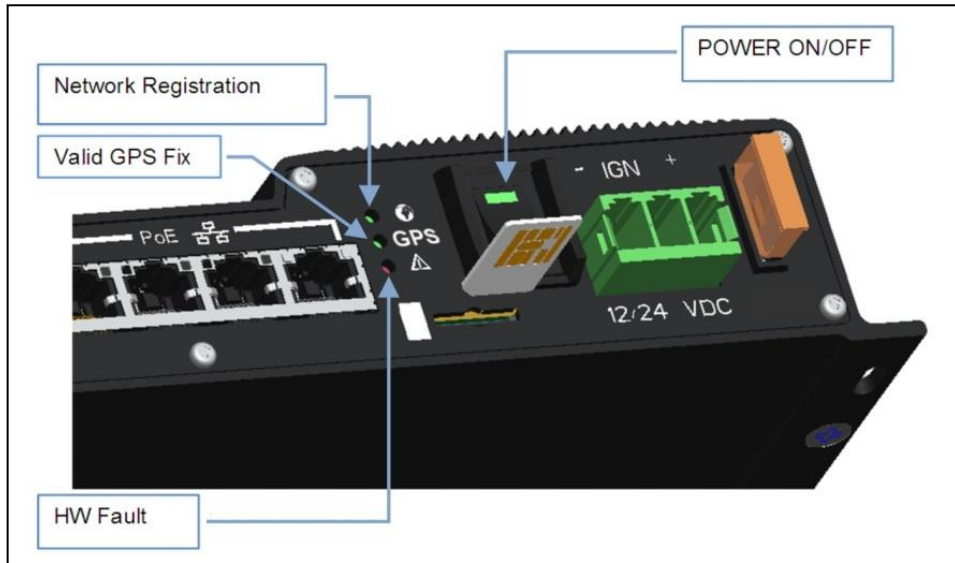

The 9450 IDU has a four RJ-45 connector with 2 LEDs for each port with the following functions:

Green/Red bicolor: Green indicates Link active; Red indicates a power over Ethernet PD device is connected and is being powered by the IDU. When both functions are active, it will appear Orange in color.

Green: Traffic indicator

Using the Hughes 9450

Auto start configuration

Since the Hughes 9450 terminal is equipped with a tracking antenna, the default configuration for the Hughes 9450 Land Mobile Terminal is as follows:

- The Hughes 9450 is configured to automatically register with the network by default: The terminal will automatically attempt to register with the network once the tracking antenna has acquired the satellite signal and obtained a GPS fix.
- The IDU has a power switch and an ignition sense line. For the unit to turn on, the power switch must be in the ON position and 12V or 24V applied to the ignition sense line. Refer to the 9450 Installation Guide P/N 3004129-0001.

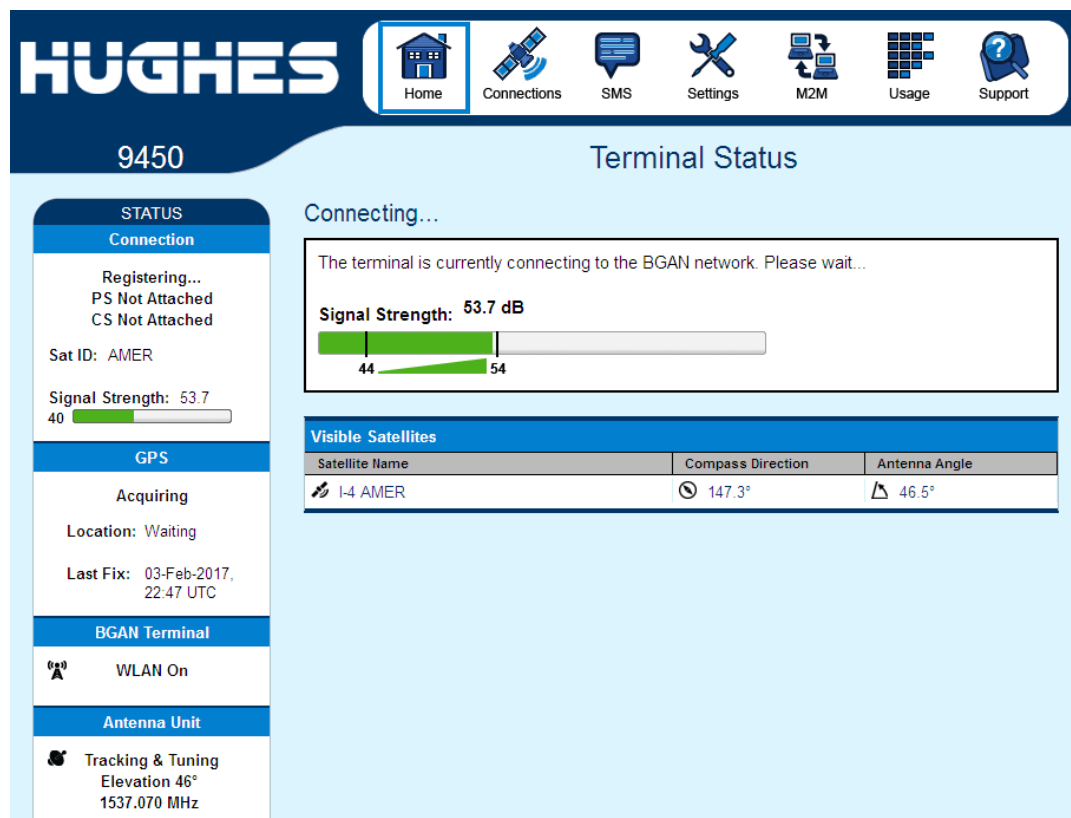

HUGHES Home Connections SMS Settings M2M Usage Support

9450 Terminal Status

STATUS

Connection

Registering...
PS Not Attached
CS Not Attached

Sat ID: AMER

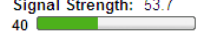
Signal Strength: 53.7
40 

GPS

Acquiring

Location: Waiting

Last Fix: 03-Feb-2017, 22:47 UTC

BGAN Terminal

WLAN On

Antenna Unit

Tracking & Tuning
Elevation 46°
1537.070 MHz

Connecting...

The terminal is currently connecting to the BGAN network. Please wait...

Signal Strength: 53.7 dB

44  54

Visible Satellites

Satellite Name	Compass Direction	Antenna Angle
I-4 AMER	147.3°	46.5°

NOTICE

These default configurations are accessible through LaunchPad or the web UI and it is recommended to keep these settings for convenient operation of the Hughes 9450 Land Mobile Terminal.

Power up and the connection to the Internet

After power is applied, the Hughes 9450 IDU and Hughes Tracking Antenna will begin their start-up sequence. The tracking antenna will begin its search for the BGAN satellite and the antenna motors may be heard during this time. Note that the tracking antenna must have line of sight to the BGAN satellite. Once the antenna has locked onto the BGAN satellite, it will continue to make minor adjustments to acquire optimum signal strength. The antenna may be heard ‘twitching’ during this time. Eventually the antenna will sit at an optimum position while the vehicle is stationary.

Once the vehicle starts moving, the Hughes Tracking Antenna will automatically track the satellite signal and keep the antenna pointed towards the satellite. During short outages (e.g. while driving under a bridge, etc.) the antenna will remain in the same position and will pick up the satellite signal immediately. For longer outages the antenna may need to repeat the search pattern to reacquire the satellite signal.

NOTICE

Circuit switched and packet switched connections will typically recover from signal outages of less than 60 seconds. User intervention **will** be required to reactivate circuit switched connections for outages longer than 60 seconds and **may** be required for packet switched connections depending upon the actual length of outage. Packet switched connections like FTP are more robust than circuit switched connections in the network.

Connecting the terminal to the computer

You can connect your computer to the 9450 IDU with one or more of the following interfaces

- Ethernet
- WLAN (not 9450E or 9450L)

NOTICE

- During initial setup, the terminal can only be configured using an Ethernet connection. Once the terminal has been configured, all interfaces can be used for data transfer.

Connecting by Ethernet

To connect the BGAN terminal to a device using Ethernet, connect an Ethernet cable to your device's Ethernet port, and insert the other end of the connector into one of the four Ethernet ports on the 9450 IDU. These four Ethernet ports support Power-over-Ethernet (PoE) (except on the 9450L and LW).

Power over Ethernet (POE)

Note, PoE is not supported on the 9450L or LW.

All 4 ports are powered by a single 48Volt DC power supply capable of outputting 61.2 Watts and 30.6 Watts at 24 Volts and 12 Volts input respectively. The ports can provide power to class 1, 2, and 3 devices as long as the total power does not exceed the wattage based on the input voltage provided. If a device is connected to a port that exceeds the maximum power available, power will not be provided to that port. The existing connections will not be affected.

Connecting by WLAN

Note, WLAN is not available on the 9450E or 9450L.

If you have not previously used the IDU's WLAN interface, it has to be enabled from the internal web UI

with your computer connected to the IDU using the Ethernet interface.

- **WLAN Power:** The default is off, which disables the WLAN feature.
- **SSID (network name):** The default is BGAN, but you can change it to whatever you want.
- **Channel Number:** This controls the radio channel number (1 through 11) used by the access point. To meet FCC regulations, channels 12 to 14 are not supported.

When configuring the WLAN, you can enable the Wireless security protocol and MAC address filtering for added security.

Once the WLAN is “Enabled” and configured, any device with a WLAN interface can detect the IDU’s WLAN SSID, and connect to it automatically.

The 9450LW supports up to 4 WLAN clients.

WLAN Security

For WLAN security, select from the following:

9450: No protection, **64 bit WEP**, or **128 bit WEP**

9450LW: No protection, **WPA**, or **WPA2**

MAC Filtering: For added security, check the box to “Enable” MAC Filtering. You can define up to 10 MAC addresses that are allowed to connect to your WLAN.

NOTICE

When WLAN is enabled, unauthorized users may be able to access your BGAN service. If WEP or WPA is enabled, you must provide other WLAN users with the security key in order for them to connect to the terminal. In NAT mode you can go to the Manage Connections page to see what computers are actually using the BGAN service.

Connecting by ISDN

Note, ISDN is not available on the 9450L or LW.

Connect an ISDN cable to your computer’s or phone’s ISDN port, and insert the other end of the connector into the Terminal’s ISDN port.

To dial, prefix the international number with 00 and terminate with #. For example, to dial a number in the USA, enter: 0018005551234#

To receive incoming calls you must configure your ISDN device with the MSN (Multiple Subscriber Number) of the service it supports. See the ISDN section for information on configuration of MSNs. To configure the MSN in your ISDN device, refer to the user guide of your ISDN device.

NOTICE

Inmarsat only allow Class 11 terminals to use ISDN at elevation angles of 45 degrees or greater and Class 10 terminals at elevation angles of 15 degrees and greater. Check with your service provider for full details.

Connecting by RJ11

Note, RJ11 is not available on the 9450L or LW.

You can connect an analog phone or fax machine to the RJ11 ports:

- The FAX port is configured for 3.1k service for fax
- The TEL port is configured for speech service for voice calls

NOTICE

Inmarsat only allow Class 11 terminals to use Fax or 3.1kHz at elevation angles of 45 degrees or greater and Class 10 terminals at elevation angles of 15 degrees and greater. Check with your service provider for full details.

To dial, prefix the international number with 00 and terminate with #. For example, to dial a number in the USA, enter: 0018005551234# (00 + Country code + phone number)

Operational note: *RJ11 and ISDN handsets cannot be connected at the same time. The 9450 will configure itself to ISDN or RJ11 mode depending on which type of handset is plugged in first, and will be in this mode thereafter.*

To switch modes, the 9450 must be rebooted with only the desired handset connected. If both types of handsets are connected at power-on, the 9450 will default to ISDN mode and RJ11 will not be operational.

Coverage Map

The Inmarsat BGAN service is operated with 4 satellites as shown below. The Hughes 9450 terminals will perform best in areas where the elevation angle is 20 degrees or higher. Lower elevation angles increase the probability of signal outages caused by trees, buildings and hilly terrain and may severely impact the usability on the move.

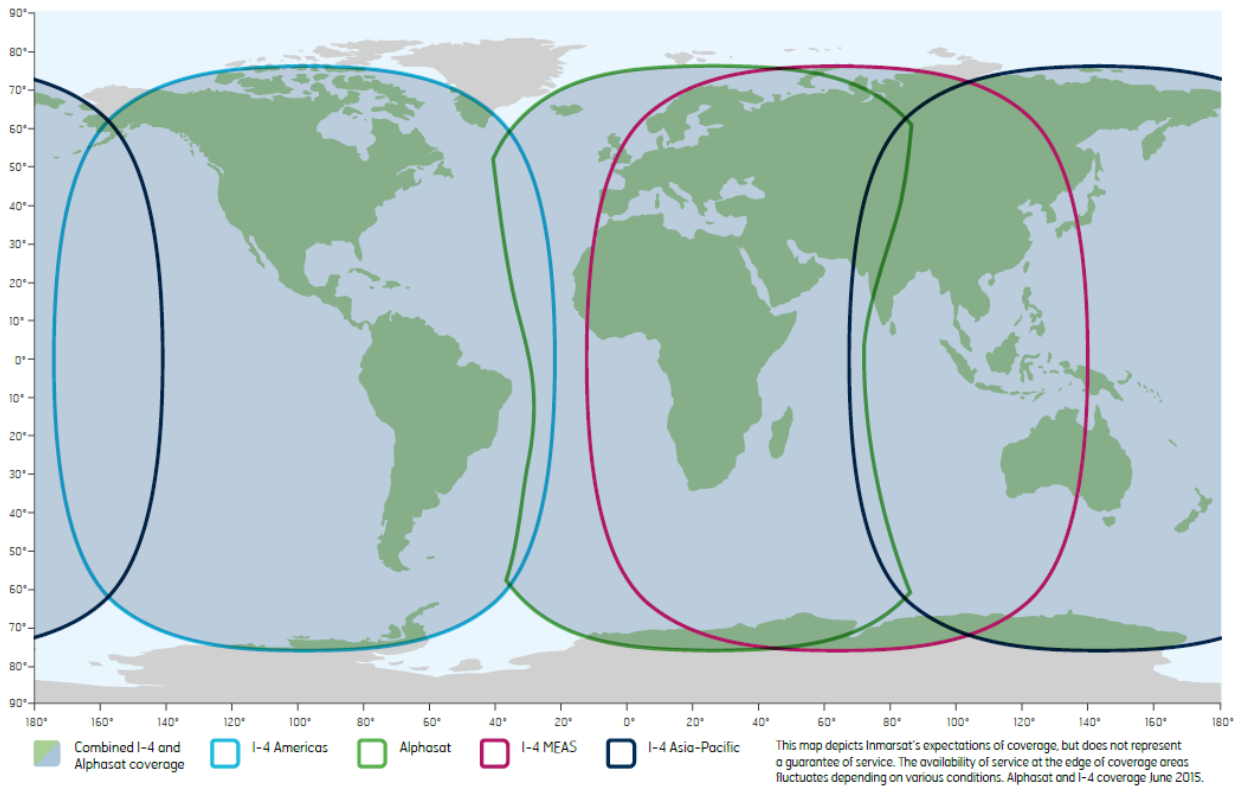

Operation in the MEAS cutout area

I-4 MEAS has a cutout area in its coverage over China and nearby parts of Asia. In this area, I-4 Asia Pacific (APAC) must be used even if MEAS is closer. For best operation in this area configure the UT to use only APAC from the General Setup page (31).

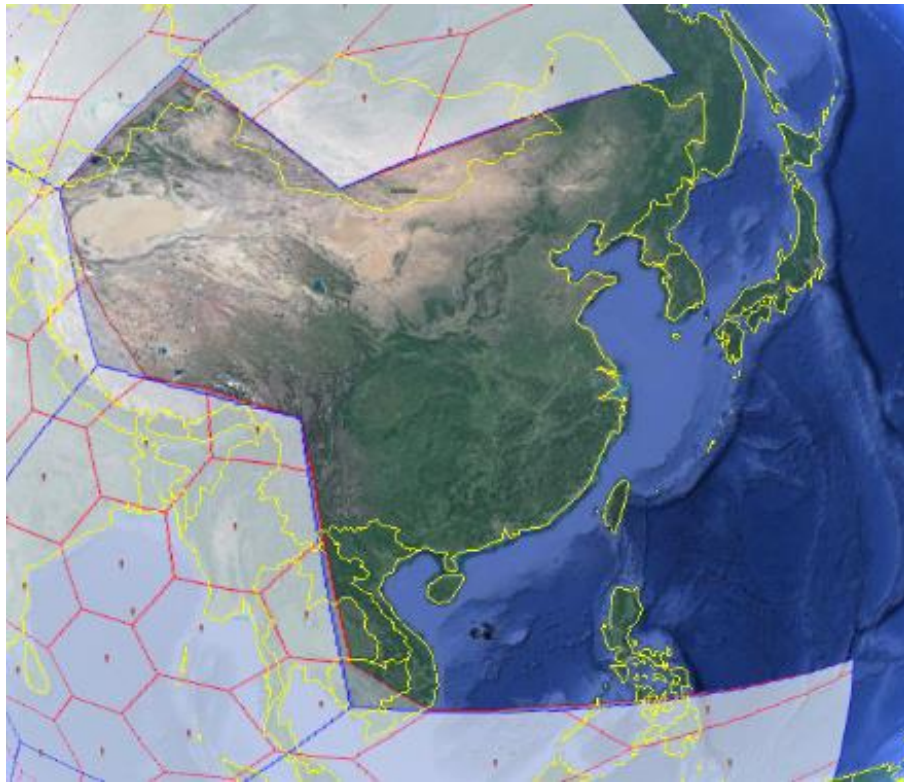

Operation in the Russian Federation

In the Territory and National Waters of the Russian Federation covered by the three Regional beams of I-4 MEAS shown below, end-users must use MEAS rather than Alphasat (EMEA) or I-4 Asia Pacific (APAC), even if one of these satellites is closer. When operating in this region, you can configure the UT to only use MEAS from the General Setup Page. In areas within the Russian Federation, but not covered by the I-4 MEAS satellite, use I-4 Asia Pacific (APAC).

Starting in release 5.7.4.0, the UT supports the Preferred Satellite Info feature. If the UT in this region tries to register on the wrong satellite, the network will command it to switch to the correct satellite.

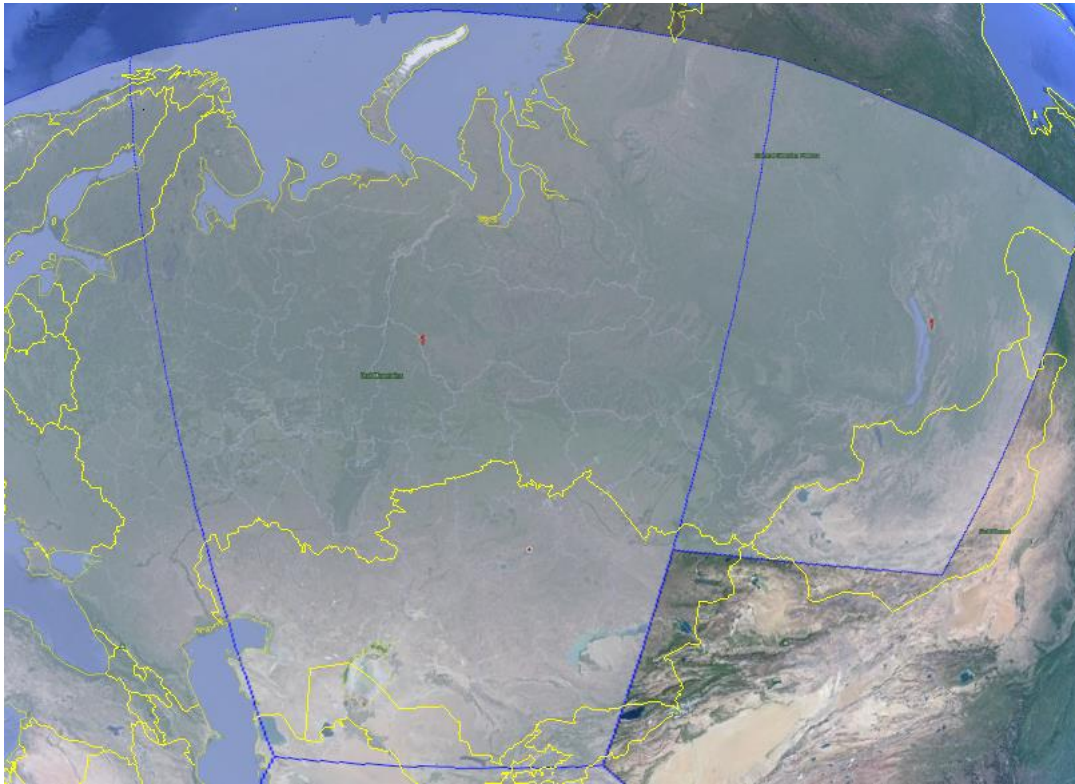

Using the Web UI

Accessing the Web UI

The Hughes UT includes its own internal Web User Interface (UI). To access the web UI, open your favorite Web Browser and type in the internal IP address of the UT e.g. **http://192.168.128.100**. The web UI opens up to the “Home” page as shown below:

HUGHES Home Connections SMS Settings M2M Usage Support

9450 Terminal Status

STATUS

Connection

- Registered
- PS Attached
- CS Attached

Beam: REGIONAL 13 AMER
Signal Strength: 57.5
40

GPS

3D GPS Fix

Location: 32.89573° N
117.20213° W
Last Fix: 03-Feb-2017,
23:47 UTC

BGAN Terminal

WLAN On

Antenna Unit

Tracking
Elevation 46°
1537.070 MHz

Current Connection

STANDARD
Charged per Megabyte
Connect

STREAMING
Charged per Minute
32k Stream
Connect

Connect using API: BGAN.INMARSAT.COM

Details

Owner	Service	API	Global IP

Visible Satellites

Satellite Name	Compass Direction	Antenna Angle
I-4 AMER	147.3°	46.5°

If the 9450 has been converted to an M2M terminal, the Home page icon will look like this e.g. **9450M**. Note streaming QoS is disabled in M2M mode.

HUGHES Home Connections SMS Settings M2M Usage Support

9450M Terminal Status

STATUS

Connection

- Registered
- PS Attached
- CS Attached

Beam: NARROW 84
Signal Strength: 67.2
40

GPS

3D GPS Fix

Location: 32 89580° N
117 20203° W
Last Fix: 09-Apr-2015, 21:38 UTC

BGAN Terminal

WLAN On

Antenna Unit

Tracking
Elevation 46°
1537.070 MHz

Current Connection

STANDARD
Charged per Megabyte
Disconnect

STREAMING
Charged per Minute
Connect

Connect using API: bgan.inmarsat.com

Details

Owner	Service	API	Global IP
192.168.128.208	Standard	bgan.inmarsat.com	161.30.22.238

Visible Satellites

Satellite Name	Compass Direction	Antenna Angle
I-4 Americas	147.3°	46.5°

Home page

The screenshot displays the Home page interface with the following sections:

- STATUS**
 - Connection**
 - Registered (with a lock icon)
 - PS Attached (with a double arrow icon)
 - CS Attached (with a telephone handset icon)
 - Beam: REGIONAL 13 AMER
 - Signal Strength: 57.5 (with a green progress bar and the number 40 below it)
- GPS**
 - 3D GPS Fix (with a globe icon)
 - Location: 32.89573° N, 117.20213° W
 - Last Fix: 03-Feb-2017, 23:47 UTC
- BGAN Terminal**
 - WLAN On (with a WLAN icon)
- Antenna Unit**
 - Tracking (with an antenna icon)
 - Elevation 46°
 - 1537.070 MHz

The Home page shows the current terminal status and allows you to setup your initial data connection.

On the left side of the page is the Status bar. These items are updated automatically when the status of any of these items change.

1. **Connection:** This field indicates whether you are Registered with the Network. It also shows the PS and CS status, beam type and receive signal quality. With release 5.7.3.1 and higher the current satellite is shown.
 - a. **PS Attach Status:** This field indicates whether you are PS (Packet Switch) attached with the Network. You will still need to setup a PDP context in order to send PS data.
 - b. **CS Attach Status:** This indicates whether you are CS (Circuit Switch) attached with the Network. Once you are CS Attached and Registered with the network, you are able to make CS calls.
2. **GPS:** This field displays the current GPS position status. If you have received a GPS fix and the Network GPS policy has been received and it allows the GPS position to be shown to the user, it will display the Latitude, Longitude, Fix Quality, and the Last time the GPS position was updated. Time displayed is UTC time.
3. **BGAN terminal:** This field indicates the WLAN status (except on the 9450E or 9450L).
4. **Antenna Unit:** This field indicates the detailed state of the tracking antenna.
 - The different tracking states are as follows:
 - Initial – this is when the 9450 is first powered On
 - Unknown – this state is when the 9450 is powering up and communication to the antenna has not started yet.
 - Tracking & Tuning – this state is when the antenna starts to track the satellite in both azimuth and elevation and is optimizing its orientation.
 - Tracking – this is the normal state when the antenna is tracking the satellite.

- Elevation: the current elevation look angle of the antenna.
- The frequency of the global beam in MHz that the antenna is attempting to track is displayed. If the unit is experiencing problems, use the table below to verify the antenna is searching for the correct satellite for your location.

The frequency is the frequency of the global beam. Possible values are the primary and secondary frequencies of the four satellites.

Satellite Designator	Region	Satellite ID	Satellite Longitude	Primary Global Frequency (MHz)	L-band Beam	Secondary L band Global Beam Frequency (MHz)
I4F1	APAC	5	143.5E	1537.485		1540.825
I4F2	AMER	7	98W	1537.070		1540.730
I4F3	MEAS	3	63.9E	1537.420		1540.915
AF1	EMEA	6	24.9E	1537.920		1541.115

In the middle of the Home page you will find the following items:

Current Connection field allows you to activate data connections for your TE. You can activate a Standard connection or a Streaming connection. For streaming connections use the drop down box to select the data rate for the stream. Streaming QoS is not available when configured for M2M mode.

Connect using APN field allows you to control the APN used for the connection.

Details show the status of the connection for this TE.

Visible Satellites shows the satellites visible for your current location and the pointing information.

NOTICE

Reference the screenshot below. The antenna angle under the **Visible Satellites** section (46.5°) may not always be exactly the same as seen under the **Antenna Unit** section showing Elevation (46°). This is due to the wide beam width of the antenna.

The following figure shows how the UI looks if you activate a Standard connection. Use the **Disconnect** button to deactivate your connection.

The screenshot displays the Hughes web interface for a terminal. At the top, the Hughes logo is on the left, and a navigation bar contains icons for Home, Connections, SMS, Settings, M2M, Usage, and Support. Below the navigation bar, the terminal ID '9450' is shown on the left, and the main heading is 'Terminal Status'.

The interface is divided into several sections:

- STATUS Connection:** Shows registration status (Registered, PS Attached, CS Attached), beam information (NARROW 84), and signal strength (68.3 dBm, 40% bar).
- GPS:** Shows 3D GPS Fix with location (32.89573° N, 117.20220° W) and last fix time (08-Jun-2015, 22:10 UTC).
- BGAN Terminal:** Shows WLAN Disabled.
- Antenna Unit:** Shows Tracking with Elevation 46° and Frequency 1537.070 MHz.
- Current Connection:** Features two panels:
 - STANDARD:** Charged per Megabyte, with a Disconnect button.
 - STREAMING:** Charged per Minute, with a dropdown menu set to '32k Stream' and a Connect button.
- Connect using API:** A dropdown menu currently set to 'bgan.inmarsat.com'.
- Details Table:**

Owner	Service	API	Global IP
192.168.128.101	Standard	bgan.inmarsat.com	161.30.22.251
- Visible Satellites Table:**

Satellite Name	Compass Direction	Antenna Angle
I-4 Americas	147.3°	46.5°

Connections

The Connections icon has three configuration areas to select from: Manage Contexts, Automatic Context Activation (ACA), and Manage APN. The following section will review each of these pages.

Manage Connections

The screenshot displays the HUGHES web interface for managing connections. The top navigation bar includes icons for Home, Connections, SMS, Settings, M2M, Usage, and Support. The main content area is titled "Manage Contexts" and shows the number "9450".

The left sidebar contains the following information:

- STATUS**
 - Connection
 - Registered
 - PS Attached
 - CS Attached
 - Beam: NARROW 84
 - Signal Strength: 69.8
 - 40
- GPS**
 - 2D GPS Fix
 - Location: 32.90598° N, 117.19913° W
 - Last Fix: 09-Apr-2015, 21:30 UTC
- BGAN Terminal**
 - WLAN On
- Antenna Unit**
 - Tracking
 - Elevation 46°
 - 1537.070 MHz

The main panel is divided into two sections:

- Close an Active Connection**

Owner	Service	APN	Global IP
192.168.128.208	Standard	bgan.inmarsat.com	161.30.22.232

Close Selected Connection
- Open a New Connection**

Owner	Service	APN
192.168.128.208	Standard	bgan.inmarsat.com

Open Selected Connection

Manage Connections page under the Data tab allows the user to setup and configure PDP contexts (data connection) for any TE that is connected to the UT. It also shows you all current Active Connections.

Open a New Connection - To open a new connection, enter the required data in the lower box.

Owner – Your current IP address is shown by default (.101), but you can change it to control connections for any other device

connected to the terminal. The page automatically displays entries for all **detected** devices and these entries can be selected to activate connections for those devices.

Service - Select the service that you want by clicking on the down arrow. The drop down list shows all of the different QoS types: standard, streaming 32K, streaming 64K, streaming 128K, and streaming 256K. Select the appropriate service required.

APN - The APN is read from the SIM card, but if you have other APN's defined (go to Manage APN page), you can use the down arrow to select a different APN. Once everything is defined correctly, click on the "*Open Selected Connection*" button. The new context will appear in the All Active Connections field above.

Close a Connection - In the upper field, all active connections are shown and you can select and close any of these connections unless an Administration Password has been enabled. See **Security** Section for more information about the administration password.

Owner	Service	APN	Global IP
192.168.128.101	Standard	BGAN.INMARSAT.COM	161.30.22.49

Close Selected Connection

Username (UN)/Password (PW): Some Service Providers require a username and password to be used when setting up a connection. This is often required when using Static Global IP addresses assigned by the Service provider. These fields can be entered when defining a new APN or when you select a different APN.

Automatic Contexts

Note, the ACA page is not available in NAPT mode.

This web page allows you to use Automatic Context Activation (ACA) in **two** different ways;

- One way is to use a static IP addresses in the TE device so you can establish an automatic PDP context with any QoS that is offered by the network (upper half of the web page).

- The second way is to use DHCP IP addresses from the UT so you can establish an automatic standard PDP context for any TE that connects via DHCP to the UT (lower part of the web page).
- There are also two ways to set the ACA whether you choose Static or DHCP. You can choose whether the context should be activated immediately for that IP address (“ON”), or if the context should only be activated when the TE attempts to send data to the satellite link (“Data”):
 - “Always ON”: Select ON in the drop down menu if you want the context to be ON all the time for that specific IP address.
 - “Data”: Select Data if you want the context to be activated when the TE attempts to send data to the satellite link

NOTICE

When using “Data” ACA, if the context is ever deactivated, it will be reactivated when more data is sent.

As of release 5.7.1.2 and higher, the “ON” option will always reactivate the context if it is deactivated, even if data is not sent by the TE.

Static IP Automatic Contexts: You can configure your own range of static IP addresses and QoS’s to use with a static automatic context.

To turn on a particular range of static addresses, select “On” or “Data” from the drop down list and choose a range of addresses, low and high to use (e.g. 192.168.128.200 to 192.168.128.202) or you can leave the defaults (192.168.128.200 to 192.168.128.209).

In release 5.7.2.4 and higher, if the ACA hi and low IP addresses are the same and the ACA is set to "ON", then the UT will activate the PDP context at startup without waiting for any IP packet from the local device. This allows contexts to be set up for devices that do not ARP. Also you can use an IP address in the DHCP range so you can control the APN plus username /password that is used for a particular local IP address. This is useful when using global static IP addresses that are to be assigned to particular local devices.

Next select the desired QoS for that range of IP addresses (e.g. **Standard**). The APN listed is the default APN read from the SIM card (bgan.inmarsat.com). If your SIM is provisioned for more than one APN, then you can select a secondary APN from the drop down list.

HUGHES Home Connections SMS Settings M2M Usage Support

9450 Automatic Contexts

STATUS
Connection
 Registered
 PS Attached
 CS Attached
 Beam: NARROW 84
 Signal Strength: 68.9
 40

GPS
 3D GPS Fix
 Location: 32.89562° N
 117.20213° W
 Last Fix: 09-Apr-2015,
 21:30 UTC

BGAN Terminal
 WLAN On

Antenna Unit
 Tracking
 Elevation 46°
 1537.070 MHz

This feature automatically connects Devices based upon their IP Addresses.
 Static IP Address Ranges cannot intersect with the DHCP Address Range.

Static IP Automatic Contexts

ACA	Enabled	IP Range (192.168.128.x)	Service	APN
1	Off	200 to 209	Standard	bgan.inmarsat.com
2	Off	210 to 219	Standard	bgan.inmarsat.com
3	Off	220 to 229	Standard	bgan.inmarsat.com
4	Off	230 to 239	Standard	bgan.inmarsat.com
5	Off	240 to 249	Standard	bgan.inmarsat.com
6	Off	250 to 254	Standard	bgan.inmarsat.com

ACA: 1 | Enabled: Off | IP Range: [] to [] | Service: Standard | APN: bgan.inmarsat.com

Update Static Settings

DHCP Automatic Contexts

	DHCP Address Range (192.168.128.x)	Service	APN (Default APN)
Off	101 to 199	Standard	bgan.inmarsat.com

Update DHCP Settings

If you want to setup additional ranges of addresses, please follow the same instructions as above.

NOTICE

You cannot overlap the IP address ranges. If you do, an error message will pop-up telling you that you have an overlap region. Check all of the ranges for overlaps and try again.

When you are finished, click on “Apply” and you should see a message saying “Operation Successful”.

DHCP Automatic Contexts: This option allows you to set up the UT for dynamic *standard* ACA. This means that any device connected to the UT via *DHCP*, whether wired or wirelessly will automatically receive a standard context.

To activate this feature, select “On” or “Data” from the drop down list under DHCP Automatic Context section and click on

“Apply”. The APN will be the default APN configured on the Manage APNs page.

Once you hit “Apply” you will get a pop-up message saying that the ACA settings were updated successfully and to take effect you will have to reboot the terminal.

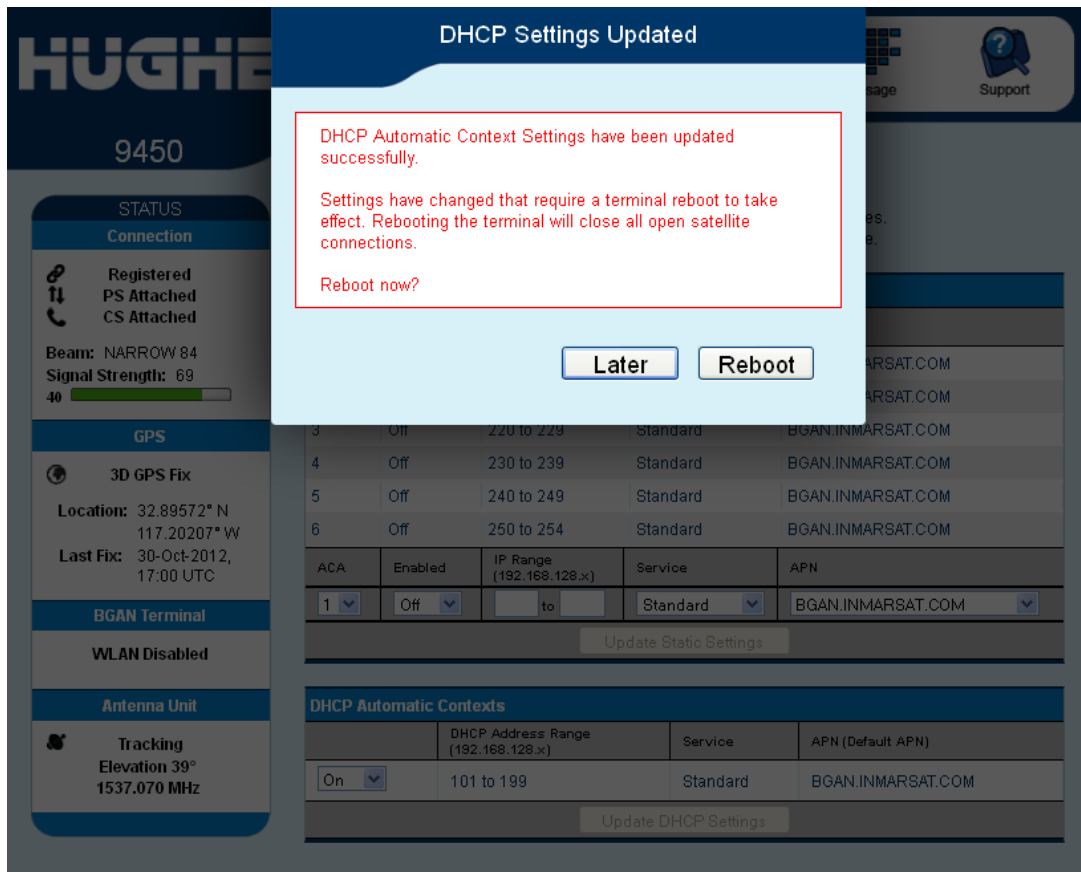

Once you reboot the terminal, check that the settings took effect.

HUGHES Home Connections SMS Settings Usage Support

9450 Automatic Contexts

STATUS

Connection

Registered
PS Attached
CS Attached

Beam: NARROW 84
Signal Strength: 69
40

GPS

3D GPS Fix

Location: 32.89568° N
117.20218° W
Last Fix: 30-Oct-2012,
16:57 UTC

BGAN Terminal

WLAN Disabled

Antenna Unit

Tracking
Elevation 39°
1537.070 MHz

This feature automatically connects Devices based upon their IP Addresses. Static IP Address Ranges cannot intersect with the DHCP Address Range.

Static IP Automatic Contexts

ACA	Enabled	IP Range (192.168.128.x)	Service	APN
1	Data	200 to 209	Standard	BGAN.INMARSAT.COM
2	Off	210 to 219	Standard	BGAN.INMARSAT.COM
3	Off	220 to 229	Standard	BGAN.INMARSAT.COM
4	Off	230 to 239	Standard	BGAN.INMARSAT.COM
5	Off	240 to 249	Standard	BGAN.INMARSAT.COM
6	Off	250 to 254	Standard	BGAN.INMARSAT.COM

Update Static Settings

DHCP Automatic Contexts

ACA	Enabled	DHCP Address Range (192.168.128.x)	Service	APN (Default APN)
1	On	101 to 199	Standard	BGAN.INMARSAT.COM

Update DHCP Settings

To see if the context has been setup properly, click on the **Data** tab>**Manage Connections** Page and this will show you all contexts that have been setup (active or inactive). See screen shot below.

Close an Active Connection

Owner	Service	APN	Global IP
192.168.128.101	Standard	BGAN.INMARSAT.COM	161.30.22.49

Close Selected Connection

Manage APNs

Some SIM cards are provisioned with multiple APNs, so you can use this page to pre-configure those additional APNs if needed. Once the APN is defined, you can select it from the drop down list without having to put in the username and password every time.

HUGHES Home Connections SMS Settings M2M Usage Support

9450 Manage APNs

STATUS
Connection
Registered
PS Attached
CS Attached
Beam: NARROW 84
Signal Strength: 69.6
40

GPS
3D GPS Fix
Location: 32.89562° N
117.20213° W
Last Fix: 09-Apr-2015,
21:30 UTC

BGAN Terminal
WLAN On

Antenna Unit
Tracking
Elevation 46°
1537.070 MHz

Enter the information supplied by your service provider to access the BGAN Network. Your APN data will be saved so the terminal can be easily configured.

Defined APNs

APN (User Name)
bgan.inmarsat.com

Remove APN Make Default

Add an APN
Access Point Name
User Name
 APN Requires Password
Password
 Remember my Password
Add New APN Save Changes

Add an APN field – Use this field to add an additional APN that you want to use, or to edit an existing APN. For adding a new APN, type in the new APN and username (if required) then select **Add New APN**. If the APN requires a password, select the “APN Requires Password” box. If you want to save the password so you don’t have to re-type it each time you configure a PDP context for that APN, check the “Remember my Password” box and then click the **Add New APN** button. (The username is always saved if entered.) The new APN name will show up in the **Defined APNs** field with the Username in parentheses. This APN will now be available to use from any APN drop down menu.

User Name /Password: Some Service Providers require a username and/or password to be used when setting up a connection. This is often required when using Static Global IP addresses assigned by the Service provider.

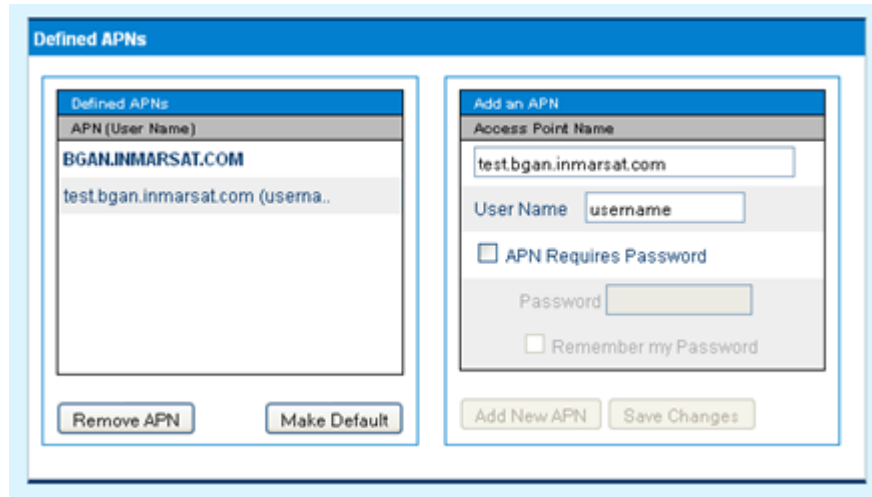

The screenshot above shows the new APN that was added, in the **Defined APNs** section.

If you wish to edit an existing APN, first select the APN to edit under the **Defined APNs** section on the left. The information for that APN will then appear in the **Add an APN** field to the right, and you can then edit it. Click the **Save Changes** button to save your changes.

Make Default. If you wish to change the default APN, select an entry in the list of Defined APNs and then click **Make Default**. This APN will now be the default APN on the other context control pages.

SMS

You can manage SMS text messages from the SMS pages which provide a similar function to LaunchPad. You must have a valid Service Center number configured in order to send messages – see the SMS Settings Page.

Send/Receive

The **Send/Receive** page allows you to view your Inbox box messages and Compose a new message. If there are more than 10 messages, you can view the older ones by changing the page number. You can also reply to received messages or forward them to another number.

You may need to periodically delete messages to prevent the SIM from filling up which will prevent the receipt of new messages. You can select a single message by checking the box next to the message and press the “Delete Checked” button. To delete multiple messages just select the check box next to each message you want to delete and click the “Delete Checked” button.

After composing a message you can save it to drafts rather than sending it, by pressing the “Save” button.

The screenshot shows the Hughes SMS interface. At the top, the 'HUGHES' logo is on the left, and a navigation bar contains icons for Home, Connections, SMS (highlighted), Settings, M2M, Usage, and Support. Below this, the page title '9450 Send/Receive SMS' is displayed. On the left side, there is a sidebar titled 'SMS MAILBOXES' with four options: 'Send/Receive' (selected), 'Saved Drafts', 'Sent Messages', and 'SMS Settings'. The main area is divided into an 'Inbox' table and a 'Compose Message' section. The 'Inbox' table has two columns: 'From' and 'At'. The 'From' column lists six phone numbers, each with a checkbox to its left. Below the table are 'Reply' and 'Forward' buttons. The 'Compose Message' section has a 'To:' field. At the bottom of the interface, there are buttons for 'Delete Checked', 'Page 1', 'Send', 'Save', and 'Characters Remaining 160'.

Saved Drafts

The **Saved Drafts** page allows you to view previously saved messages. After editing a message you can resave (Save) or send the message (Send). You can also compose a message from this page.

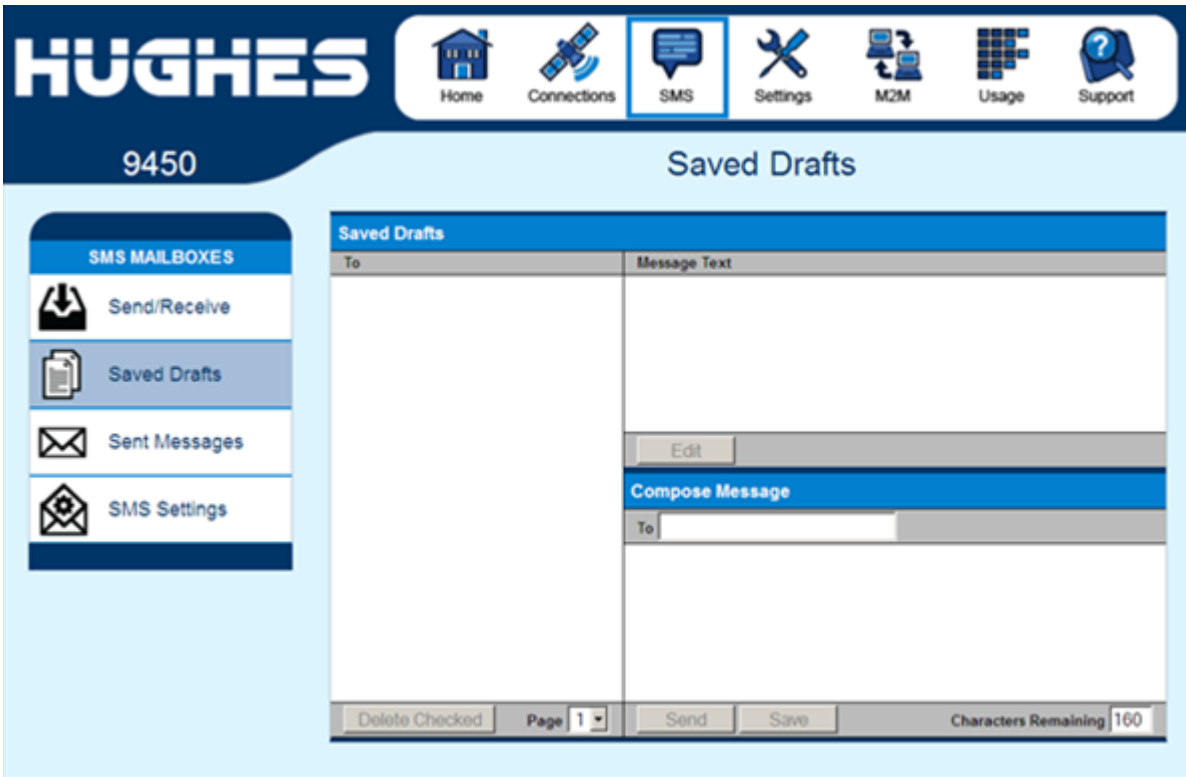

Sent Messages

The **Sent Messages** page allows you to view previously sent messages. Again, you may need to periodically delete messages to prevent the SIM from filling up. You can also compose a new message from this page.

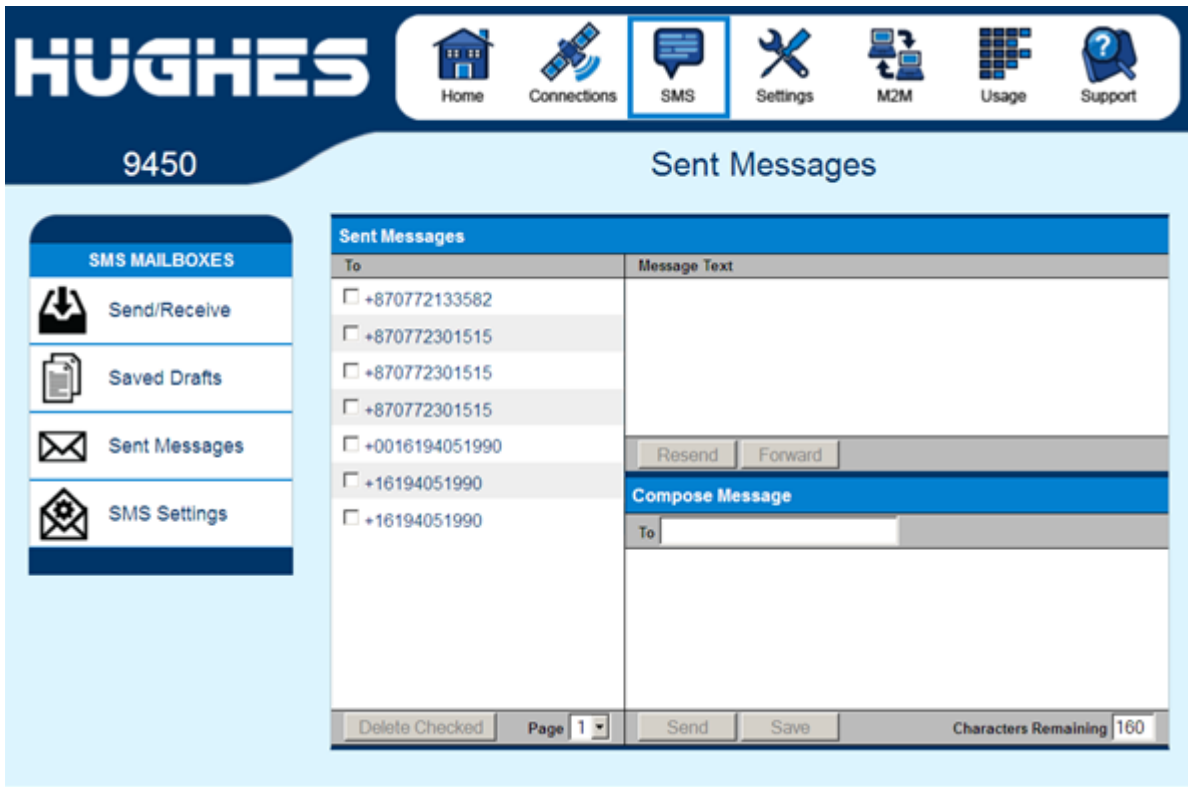

SMS Settings

On the **SMS Settings** page you can configure the default settings for messages. You must have a valid Service Center number configured in order to send messages. The default Service Center number is +870772001799.

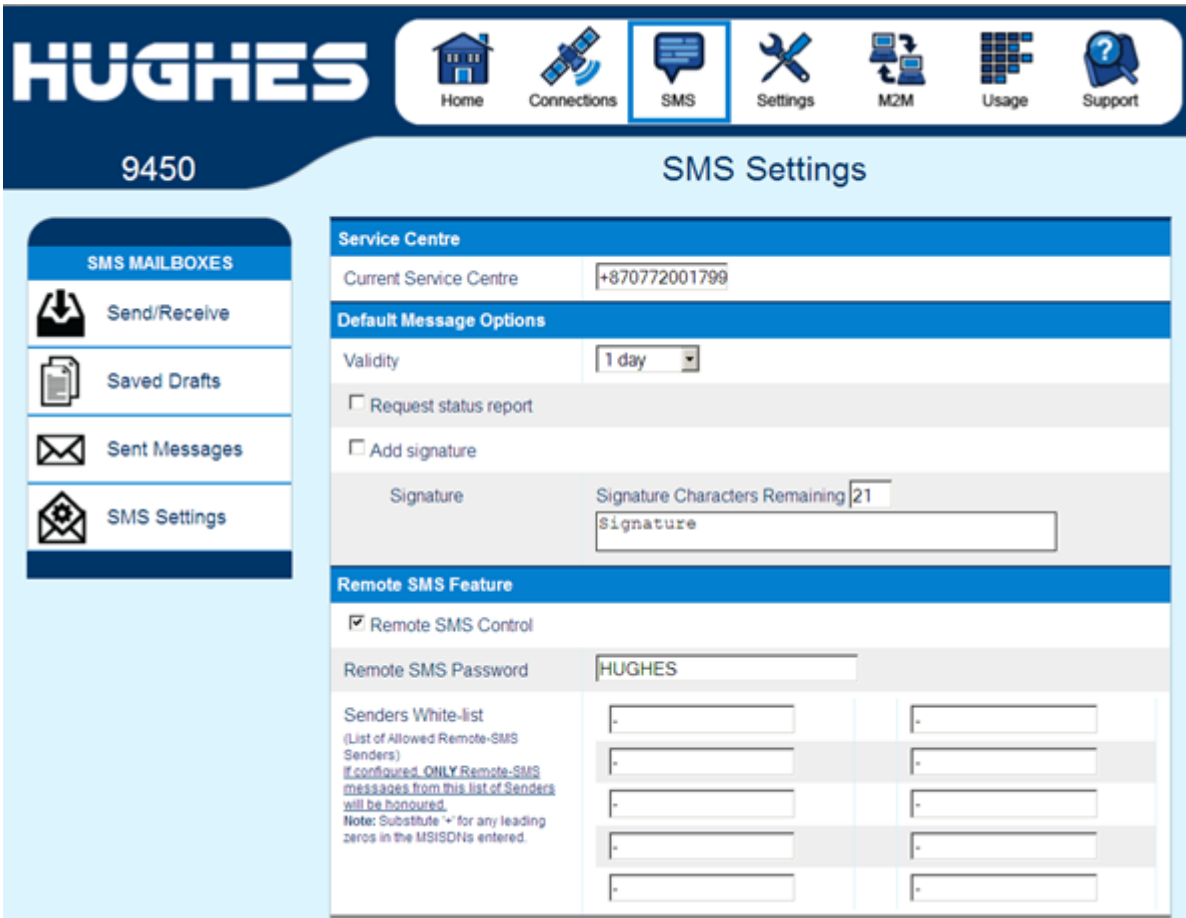

On the **Remote SMS Feature** section you can enable the unit to receive and act on special remote control SMS messages. This Feature is activate by default on the Features page, but before it can be used, it must be Enabled on this page.

You can configure the password that must be contained in remote control SMS messages. Be sure to make a note of the password if you change it from the default. **Note:** If you activate this feature and do not change the password, it is possible that other people may be able to send control messages to your unit.

Remote control messages will be deleted after they are received and will not be stored in the SIM.

Senders White-list – is a list of numbers that the terminal will allow a remote SMS message to come from. When entering the number use the + symbol in front of the country code e.g., +870 or just start with the country code e.g., 870. Do not use 00 in front of the country code.

Settings page

General Setup

This page allows the user to configure various parameters of the UT. A description of each item on this page follows:

Terminal Startup – The default configuration for the 9450 terminal has Bypass Antenna pointing and Always power on checked and grayed out due to the tracking antenna.

Connection: Always Connect to Satellite: The default configuration is always set to Automatic. This parameter is used within a satellite overlap region and allows the user to override the default satellite (selected by the 9450 terminal based upon elevation angle/GPS location) and select a different satellite.

HUGHES Home Connections SMS **Settings** M2M Usage Support

9450 General Setup

ALL SETTINGS

- General Setup
- IP Address / DHCP
- Wireless LAN
- WLAN Security
- Telephony
- Security
- Features

Terminal Startup

- Bypass the Antenna Pointing mode when the terminal is powered up
- Always power on the terminal when it is connected to mains

Connection

- Always Connect to Satellite: Automatic
- Secondary Frequency Search: Default

Streaming

- Enable Streaming Inactivity Timer
- Streaming Timeout: 5 Minutes

Emergency Call Numbers

- Emergency Call Numbers: 000:008:112:110:118:119:911:999

Apply Changes

NOTICE

This change does not take effect until the UT is reset. When set to Automatic, the UT will select the satellite based on the unit's GPS position. When set to a specific satellite, it will attempt to use that satellite only. Be careful to select the correct satellite for your position.

Secondary Frequency Search: (New in release 5.7.4.0.) By default the antenna will not search for secondary satellite frequencies. Inmarsat does not broadcast the secondary frequencies and so searching for them would slow down antenna satellite search and recovery, especially in blockage or overlap conditions. However, if Inmarsat should ever announce they have switched to using a secondary frequency on a satellite, enable this parameter if using that satellite.

Streaming – By enabling this parameter, the user can turn on a timer for inactivity for a streaming QoS that has been set up. The timer is in either seconds or minutes and will tear down a streaming context after **X** seconds or minutes of inactivity.

Emergency Call Numbers: Allows the user to add the emergency call number that is applicable in the part of the world where the terminal is being used, if it is not already defined.

The 9450L, 9450E and 9450LW offer a reduced set of interfaces and so the WLAN and Telephony pages are only available when applicable. For example, the General Settings page appears as shown below on the 9450L with reduced links in the status bar.

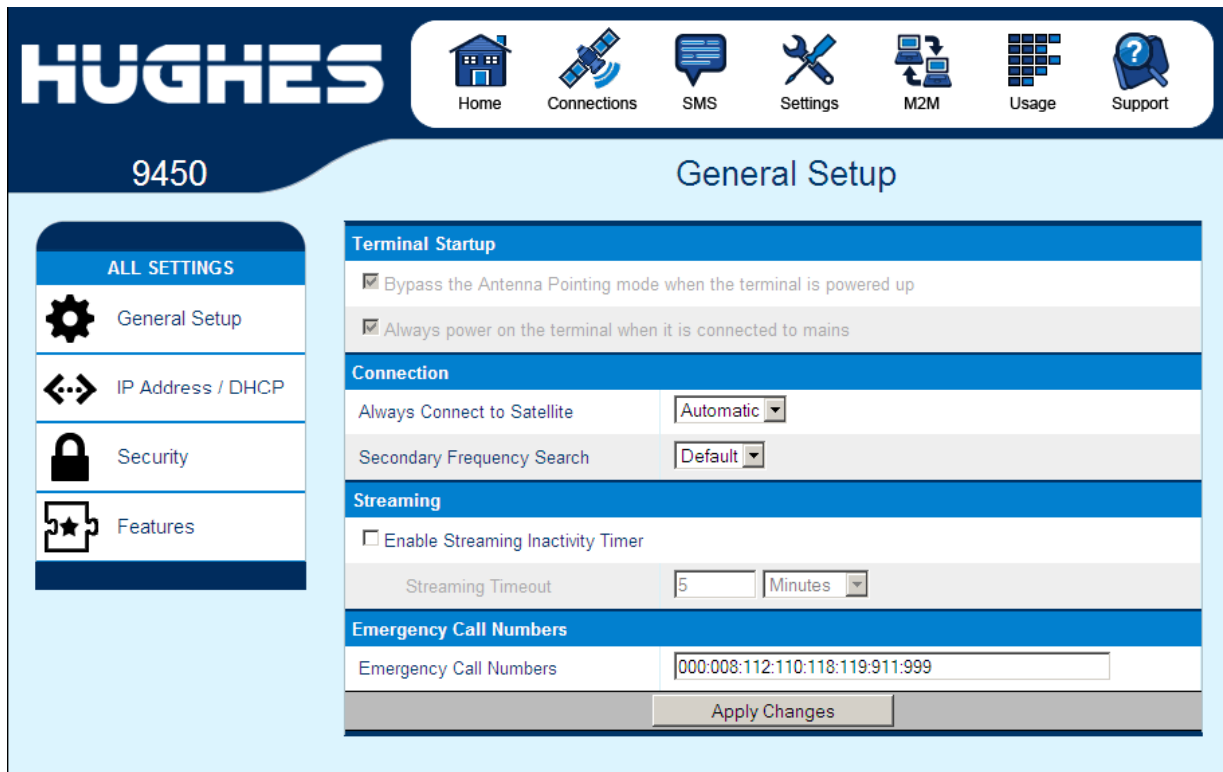

IP Address/DHCP Settings

Terminal Local IP Address: This page allows the user to change the local IP address of the terminal from the default 192.168.128.100 IP address. All four octets are available to change. Once the local IP address is changed on this page and applied, the IP address ranges for the DHCP server, the Manage Context page and ACA page will also be changed automatically.

NOTICE

Updates to this field will **not** take effect until the UT is **rebooted**.

DHCP Server: allows the DHCP server in the UT to be turned on or off by checking the Enable box.

DHCP Address Range: This allows the user to set the range of DHCP addresses that are given out by the UT to any connected TE.

Lease Time when idle: Idle-mode DHCP Lease Time refers to the DHCP lease time when the UT is not connected to the network. This parameter allows the user to change the default time (60 seconds) that the DHCP lease to the TE is good for. This parameter was introduced because of a problem with some models of Cisco routers that will not accept a short DHCP lease time.

NOTICE

The longer the Idle-mode DHCP lease time, the longer it will take the Network/UT to update the TE with the correct DNS servers for web browsing after establishing a data context.

Lease Time when connected: The Connected-mode DHCP Lease Time refers to the DHCP lease time when the UT is connected to the network. Most users will have no need to change this parameter.

ALL SETTINGS

- General Setup
- IP Address / DHCP
- Wireless LAN
- WLAN Security
- Telephony
- Security
- Features

Terminal Local IP Address

Terminal Local IP Address: 192 . 168 . 128 . 100

DHCP Server

Enable DHCP Server

DHCP Address Range: 192.168.128. 101 to 199

Lease Time when Idle: 1 Minutes

Lease Time when Connected: 1 Minutes

Network Operating Mode

Netmode: NAT mode

Apply Changes

Ethernet MAC Address Filtering

Enable Ethernet MAC Address Filtering

Allowed Mac Addresses	
MAC Address	

Remove

Add A Detected Device	
IP Address	MAC Address
192.168.128.101	00:22:6b:c3:a7:b8

Add

Apply

Network Operating Mode: The Netmode field indicates the mode of operation of the terminal. In NAT mode the UT will translate between the local and global IP addresses. In NAPT mode the UT will also do port translation so multiple local devices can share a single context. In Relay mode the UT will supply the global IP address to the TE once a PDP Context is established. Relay mode is single user/single PDP Context and only supports a single connected TE. In the 9450LW, Relay mode cannot be used with WLAN.

Note: Updates to this field will not take effect until the UT is restarted.

Nat Mode

In **NAT mode** once a PDP context is active, the UT will translate between the local and global IP addresses. This is a basic NAT that only performs IP address translation. It does not use port translation.

NAPT Mode

In **NAPT mode** (5.7.3.0 and above) multiple devices share a single PDP context. The port translating NAT modifies both IP addresses and port numbers so multiple devices can share the single global IP address assigned to the PDP context.

In NAPT mode, only a single context is supported. By default the Always On Context is activated on the M2M page. The ACA page is removed. A Port Forwarding page is added under Settings and can be used to configure the DMZ and Port Forwarding.

Relay Mode

In **Relay mode** the UT will supply the global IP address to the TE when the context is established. Relay mode is single user and only supports a single connected TE.

In Relay mode DHCP is required to provide the global IP address to the TE. When the context is activated, the DHCP server in the UT will NACK the next DHCP lease renewal from the TE and assign the global IP address assigned by the network. The local IP connection will be torn down and reestablished as the IP address changes. Similarly, when the context is deactivated the DHCP server will NACK the lease renewal and then reassigns the original private IP address.

LaunchPad and the Web UI will lose and reestablish their connections to the terminal as the IP address is changed.

To make the IP address change happen quickly a short DHCP lease should be used. The terminal defaults the DHCP lease time to 60 seconds in idle and connected mode.

NOTICE

Relay mode only supports a single user TE.

WLAN is not supported in Relay mode with the 9450LW.

Ethernet MAC Address Filtering: When this feature is enabled, only the MAC addresses that you select can connect to the terminal. A maximum of ten (10) addresses can be allowed.

Check the box to “Enable MAC Address Filtering”

If any TE is already connected to the terminal via Ethernet, the MAC address of that TE will be detected and show up in the “Add a Detected Device” field.

To add the detected MAC address, click on the address to highlight it and then click Add. It will now show up in the “Allowed MAC Address” field.

Port Forwarding Page

The Port Forwarding page is only available in NAPT mode and includes:

- DMZ – if enabled, all packets received from the space link that are not routed to other addresses will be forwarded to the DMZ host address.
- Port Forwarding Rules. These fields allow you to configure rules defining how packets of particular protocols are routed, e.g. TCP port 80 for HTTP. Port Forwarding rules are applied before the DMZ rule.

In the 6.7.x.y releases, the third octet of the IP address is configurable to support the separate WLAN subnet.

HUGHES Home Connections SMS Settings M2M Usage Support

9450 Port Forwarding

ALL SETTINGS

- General Setup
- IP Address / DHCP
- Port Forwarding
- Wireless LAN
- WLAN Security
- Telephony
- Security
- Features

DMZ Configuration

Enable DMZ Host

DMZ Host IP Address: 192.168.128.101

Apply Changes

Port Forwarding Rules

Rule	Enabled	Global Port	Protocol	Local IP (192.168.128.x)	Local Port
1	Off	0	TCP	0	0
2	Off	0	TCP	0	0
3	Off	0	TCP	0	0
4	Off	0	TCP	0	0
5	Off	0	TCP	0	0

Update Port Forwarding Rules

Wireless LAN

The Wireless LAN settings page allows the user to enable, disable, and configure the Wireless LAN functionality of the terminal. The page is not available in the 9450E or 9450L.

The page from release 5.7.x.y for the 9450 is shown below.

HUGHES Home Connections SMS **Settings** M2M Usage Support

9450 Wireless LAN Settings

ALL SETTINGS

- General Setup
- IP Address / DHCP
- Wireless LAN
- WLAN Security
- Telephony
- Security
- Features

Enable Wireless LAN

Enable Wireless LAN Interface

Network Name Settings

Network Name (SSID)

Allow Others to see your wireless Network Name

Region and Channel

Network Region

Network Channel

Security is currently disabled on your wireless network.
Click here to modify the security settings.

NOTICE

The Wireless LAN Security is controlled on a separate web page – WLAN Security.

If you have not previously used the terminal’s WLAN interface, it must first be enabled from this page using a computer connected to the terminal using an Ethernet connection. Once WLAN is enabled/configured, TEs can connect to the terminal wirelessly.

Fields on this page include:

Enable Wireless LAN Interface: Turns the Wireless LAN interface on/off. The default is off (unchecked).

Network Name (SSID): The default is “BGAN”, but you can change it to whatever you want.

You can “hide”/prevent the SSID from being broadcast. This feature can make WLAN hard to use and does not provide real security and so was removed in the newer 9450LW.

Network Region: There is only one region for all countries.

Network Channel: This controls the radio channel number (1 through 11) used by the access point. To meet FCC regulations, channels 12 to 14 are not supported.

NOTICE

If performance issues occur over the WLAN interface, changing the Channel may help.

In release 6.7.x.y for the 9450LW, a new field is added to allow the user to configure the IP address for the WLAN interface. In the LW the WLAN card must be in a different subnet from the Ethernet ports. By default it is set to a subnet 1 higher than the Ethernet subnet, e.g. 192.168.129.100. The WLAN clients will be assigned addresses in this subnet.

The 9450LW does not allow hiding of the SSID.

HUGHES Home Connections SMS **Settings** M2M Usage Support

9450 Wireless LAN Settings

ALL SETTINGS

- General Setup
- IP Address / DHCP
- Wireless LAN
- WLAN Security
- Security
- Features

Enable Wireless LAN

Enable Wireless LAN Interface

Network Name Settings

Network Name (SSID)

Network Address Settings

Wireless LAN IP Address

Region and Channel

Network Region

Network Channel

Security is currently disabled on your wireless network.
[Click here to modify the security settings.](#)

Wireless LAN Security

This page allows the user to configure security for the wireless link. Note, the page is not available in the 9450E or 9450L.

HUGHES Home Connections SMS Settings M2M Usage Support

9450 WLAN Security Settings

ALL SETTINGS

- General Setup
- IP Address / DHCP
- Wireless LAN
- WLAN Security
- Telephony
- Security
- Features

General WLAN Security Settings

Secure the Wireless Network using

Allow Others to see your wireless Network Name (SSID)

Enable Wireless LAN MAC Address Filtering

Your Wireless LAN connection is currently unprotected.

Apply

Wireless LAN MAC Address Filtering

Allowed Mac Addresses
MAC Address

Remove

Add A Detected Device	
IP Address	MAC Address

Add

For security, select from the down arrow:

9450 No protection, 64 bit WEP, or 128 bit WEP
9450LW No protection, WPA, or WPA2

For WEP, you can define the WEP key or use the default key, which is formulated using the IMEI number of the terminal (e.g. IMEI number plus 0123456789).

- Hexadecimal 128-bit: Requires 26 characters.
Recommended
- Hexadecimal 64-bit: Requires 10 characters

For WPA and WPA2 on the 9450LW, define an 8 to 63 character passphrase.

SSID Broadcast

Check the box if you want your SSID name to be broadcast (default). This feature is not available on the 9450LW and the SSID is always broadcast.

MAC Address Filtering

Check the box to “Enable MAC Address Filtering”. If any TE is already connected to the terminal wirelessly, the MAC address of that TE will be detected and show up in the “Add a Detected Device” field.

To add the detected MAC address, click on the address to highlight it and then click Add. It will now show up in the “Allowed MAC Address” field. A maximum of ten (10) addresses can be filtered.

When wireless security is selected, extra fields are displayed to allow the user to configure the relevant security information. For example, WPA2 (on the 9450LW) is shown below.

HUGHES Home Connections SMS **Settings** M2M Usage Support

9450 WLAN Security Settings

ALL SETTINGS

- General Setup
- IP Address / DHCP
- Wireless LAN
- WLAN Security
- Security
- Features

General WLAN Security Settings

Secure the Wireless Network using **WPA2 Protection**

Enable Wireless LAN MAC Address Filtering

WPA2

WPA2 Passphrase

Hide Keys

AES Update Interval

3600 secs

Apply

MAC Address Filtering

Allowed MAC Addresses	
MAC Address	

Remove

Add A Detected Device	
IP Address	MAC Address
192.168.129.101	B4:6D:83:44:33:AB

Add

Telephony

Various RJ11 and ISDN settings can be controlled from the Telephony Settings page. For instructions on connecting and using POTS and ISDN devices, refer to page 9.

Note the service restrictions per terminal class on page 9.

Note this page is not available on the 9450L or LW.

The screenshot shows the Hughes 9450 Web UI. The top navigation bar includes Home, Connections, SMS, Settings (highlighted), M2M, Usage, and Support. The page title is '9450 Telephony Settings'. The left sidebar lists 'ALL SETTINGS' with options: General Setup, IP Address / DHCP, Wireless LAN, WLAN Security, Telephony (selected), Security, and Features. The main content area is titled 'Telephony Settings' and contains the following sections:

- Telephony Settings:** Call Progress Tones set to 'Option 1'.
- ISDN Settings:** 'Enable ISDN Power Sourcing' is checked. 'Select the outgoing Call Type using' is set to 'the Device MSN Settings'.
- Device MSN Settings - Voice / FAX Devices:**

Call Type	Multiple Subscriber Number (MSN)
Standard Voice, 4kbps Quality	1
Premium Voice / FAX (3.1 kHz Audio)	2
- Device MSN Settings - 64 kbps Data Devices:**

Data Type	Multiple Subscriber Number (MSN)
64 kbps Clear Data (UDI)	3
64 kbps Restricted Data (RDI)	3

An 'Apply Changes' button is located at the bottom of the settings area.

Telephony Settings:

Call Progress Tones: Two options are provided for call progress tones. Option 1 is the default tones used in the USA. Option 2 provides an alternative set of tones that are used in Brazil and some European countries.

Call Progress Tone	Option 1 (US)		Option 2 (Alternative)	
	Freq (Hz)	Cadence	Freq (Hz)	Cadence
Dial	350 + 440	Steady ON	425	Steady On
Ring Back	440 + 480	2 sec ON 4 sec OFF Repeating	425	1 sec ON 4 sec OFF Repeating
Network Congestion	480 + 620	0.25 sec ON 0.25 sec OFF Repeating	425	0.5 sec ON 0.5 sec OFF Repeating

Call Progress Tone	Option 1 (US)		Option 2 (Alternative)	
	Freq (Hz)	Cadence	Freq (Hz)	Cadence
Busy	480 + 620	0.5 sec ON 0.5 sec OFF Repeating	425	0.25 sec On 0.25 sec OFF Repeating

ISDN Settings:

Enable ISDN Power Sourcing: To turn on the ISDN power sourcing, click the check box in the upper left-hand corner that says “Enable ISDN Power Sourcing” and then click on “Apply”. The ISDN device should receive 40V power immediately via the ISDN cable. This field should be on unless you never use ISDN or are using an ISDN device that has its own power source.

Select the outgoing call type using: This box controls the mechanism used by the terminal to select the bearer type for mobile originated calls. By default, “**the Device Bearer capability**” is set as the trigger in this drop down list. Most ISDN devices correctly signal the call type (speech, 3.1KHz audio, UDI, RDI) via the bearer capability.

There is also an option under the drop down arrow to set the trigger to use the **MSN** rather than the bearer. If there is a problem using the bearer capability setting, this field can be changed to use the MSN number instead.

Device MSN Settings - Voice/FAX Devices

Standard Voice: By default, MSN 1 is used for standard voice (speech). To receive incoming calls, you must program the same MSN into your ISDN handset connected to the ISDN port.

Premium Voice/Fax (3.1 kHz Audio): By default, MSN 2 is used for 3.1 KHz Audio. To receive incoming calls, you must program the same MSN into your ISDN fax machine connected to the ISDN port.

Device MSN Setting - 64 kbps Data Devices

64 kbps Clear Data UDI (Unrestricted Digital Information): By default, MSN 3 is used for UDI calls. UDI is a 64 Kbps service that is a European standard ISDN.

64 kbps Restricted Data RDI (Restricted Digital Information): By default, MSN 3 is used for RDI calls. RDI is a 56 Kbps service found in the USA.

Once all changes have been made, click on “Apply”.

NOTICE

You can use different MSNs for any of the ISDN call types above, but your ISDN equipment must be programmed with the same MSN to accept incoming calls, and you must use different numbers for speech, audio and UDI/RDI calls.

Security

You can configure three separate security settings on this page:
1) SIM PIN, 2) Phone to SIM PIN, and 3) Administration Password.

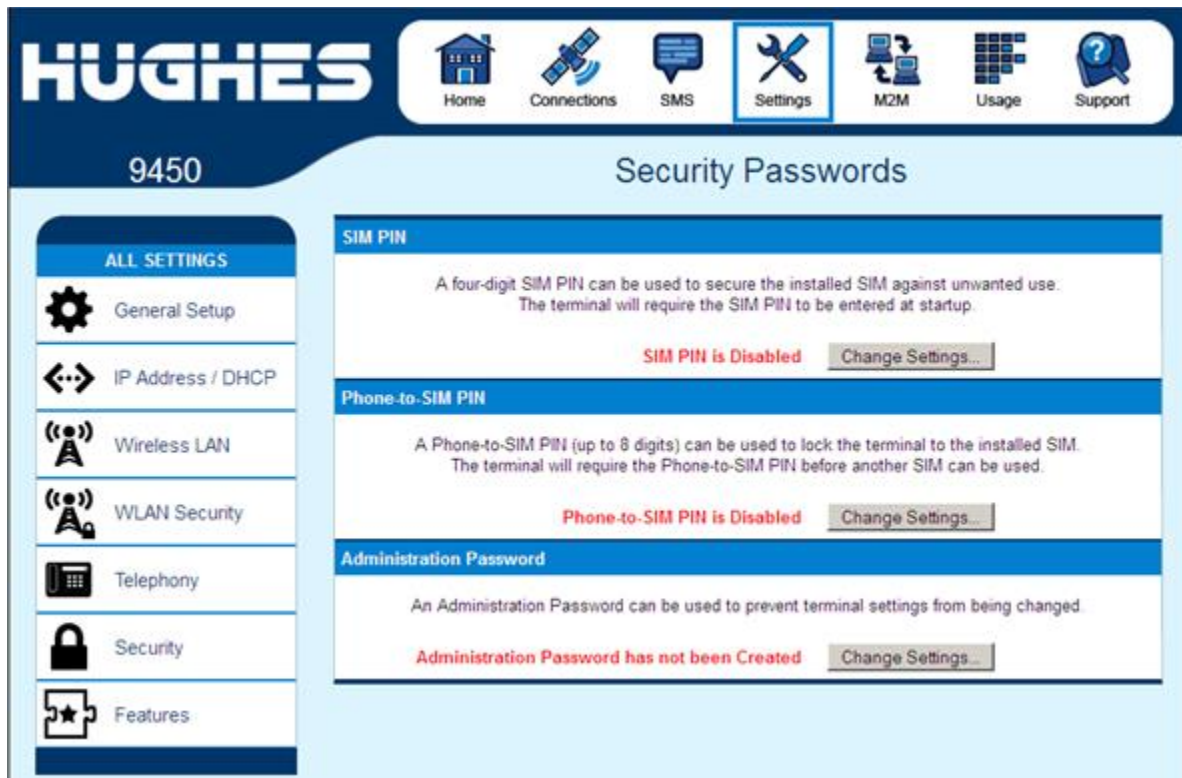

SIM PIN – this is a four digit field can be Enabled and configured by the user to secure the terminal against unwanted use. Once enabled, the terminal will require the SIM PIN at startup.

Phone to SIM PIN – use up to 5 digits to lock the terminal to that particular SIM. The Phone to SIM PIN will have to be entered any time the SIM card is changed. This setting is similar to a GSM phone's security code. Default password is 12345.

Administration Password – this configuration allows the user to prevent terminal settings from being changed once the

terminal is configured properly. This password will have to be entered before any settings can be changed.

Additionally, when the 9450 is in M2M mode, the AT command port (IP port 1829) is locked by default and the command: *AT_ICLCK="AD",0,"<admin password>"* must be used to unlock it before AT commands can be used. Both mechanisms use the same password but the AT command port and each Web UI session use a separate lock and must be individually unlocked.

If no administration password is defined, the AT port uses "admin" by default.

Note that this feature blocks LaunchPad in M2M mode as LaunchPad does not support the iclck command.

Features

You can enable special features from this page.

The screenshot shows the Hughes 9450 web interface. At the top, there is a navigation bar with icons for Home, Connections, SMS, Settings (highlighted), M2M, Usage, and Support. Below this, the page title is '9450 Feature Management'. On the left, there is a sidebar menu under 'ALL SETTINGS' with options: General Setup, IP Address / DHCP, Wireless LAN, WLAN Security, Telephony, Security, and Features (selected). The main content area contains a table titled 'Features' with the following data:

Feature Name	Feature Status	Activate	Deactivate
SMS Remote Management	Active		
M2M Mode	Inactive		

Below the table, there is a text input field labeled 'Feature Act/Deact Code:' with the value '89445624' entered. Below the input field is a button labeled 'Act/Deact Feature'.

Features:

SMS Remote Management: this feature is Active by Default and it allows the unit to receive and act on special remote control SMS messages. Even though this feature is activated, before this feature can be used you must enable SMS remote on the **SMS Settings** page.

M2M mode: This feature allows you to convert the 9450 into a 9450- M2M terminal and allows you to use an M2M SIM card and the M2M Service plans. In order to activate this feature, you must get the **Activate Code from** your Distribution Partner. Once you have the Activate Code, you can switch back and forth between BGAN services and M2M Services.

In release 5.7.3.1 and above, no feature code is required and the UT will automatically switch between BGAN services and M2M mode based on the type of SIM inserted. Power off the unit before changing the SIM card.

NOTICE

In M2M Mode streaming QoS is not supported and so is removed from the Web pages.

Once you click on Act/Deact Feature button, you will get a Pop-up window similar to the screenshot below. At this time, you should power down the terminal with the Power button. Once completely powered down you need to remove the BGAN SIM card and replace it with an M2M SIM card.

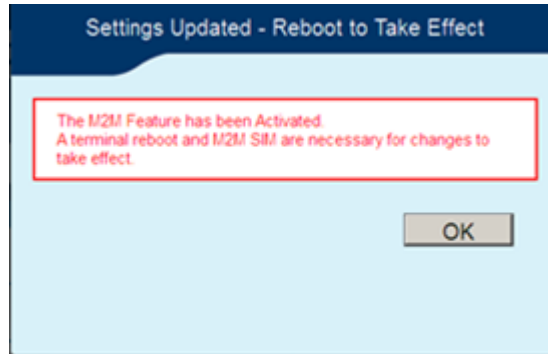

Once the terminal is rebooted, it comes up showing the model number as **9450M** (M2M).

HUGHES

Home Connections SMS Settings M2M Usage Support

9450M Feature Management

ALL SETTINGS

- General Setup
- IP Address / DHCP
- Wireless LAN
- WLAN Security
- Telephony
- Security
- Features

Feature Name	Feature Status	Activate	Deactivate
SMS Remote Management	Active	<input type="radio"/>	<input type="radio"/>
M2M Mode	Active	<input type="radio"/>	<input type="radio"/>

Feature Act/Deact Code:

Act/Deact Feature

M2M Page

The M2M page includes the following configurable parameters:

Ping Configuration:

- Context Watchdog - On/Off
- Primary Ping Address
- Secondary Ping Address
- Tertiary Ping Address
- Time between Pings
- Ping required - Yes/No. If set to “No”, then the system will not try to ping on timer expiration if data was transmitted within the watchdog period.

Always On Context:

- Always on context - On/Off (default is On)
- Always on static IP address. If the TE has a known static IP address or never ARPs, enter this address. Alternatively, leave the IP address blank (0.0.0.0) and the UT will set up a context for the first device it detects through ARP at startup.
- APN drop down box

The screenshot displays the Hughes M2M Setup web interface. The top navigation bar includes icons for Home, Connections, SMS, Settings, M2M (highlighted), Usage, and Support. The main content area is titled "M2M Setup" and is divided into two sections: "Ping Configuration" and "Always ON Context".

Ping Configuration:

- Context Watchdog: On Off
Sends a PING to keep the context alive and test connectivity. If ping fails and the unit can not recover, resets unit.
- Primary Ping IP Address:
- Secondary Ping IP Address: (Optional)
- Tertiary Ping IP Address: (Optional)
- Time between Pings: minutes
- Ping Required: Yes No
(Always send ping even if other data sent recently)
-

Always ON Context:

- Always On Context: On Off
- Static ACA IP Address:
(If the Local IP address field is left blank, a context will be set up for the first device detected via an ARP)
- QoS:
- APN Config:
-

STATUS:

- Connection:** Registered, PS Attached, CS Attached. Beam: NARROW 84, Signal Strength: 69.0/40.
- GPS:** 3D GPS Fix. Location: 32.89565° N, 117.20213° W. Last Fix: 09-Apr-2015, 21:34 UTC.
- BGAN Terminal:** WLAN On.
- Antenna Unit:** Tracking, Elevation 46°, 1537.070 MHz.

Usage Page

This web page provides an estimate of the amount of Packet Switched data that was sent and received, along with time spent on streaming connections and CS calls. The data is broken up into two types:

Trip Usage Statistics: The trip counter is similar to the trip counter on your vehicle. It can be zeroed out at any time by the user and it will track the statistics until the user resets it.

Lifetime Usage Statistics: The Lifetime counter is similar to the odometer on your vehicle. It shows the statistics of the terminal since the software version that added this feature was loaded onto the UT. The user **cannot** reset these counters.

HUGHES Home Connections SMS Settings M2M Usage Support

9450 Usage Statistics

STATUS
Connection
Registered
PS Attached
CS Attached
Beam: NARROW 84
Signal Strength: 69.0
40

GPS
3D GPS Fix
Location: 32.89565° N
117.20213° W
Last Fix: 09-Apr-2015,
21:34 UTC

BGAN Terminal
WLAN On

Antenna Unit
Tracking
Elevation 46°
1537.070 MHz

Trip Usage Statistics

Standard Class Data Transfers	Trip Total (MB)	
Standard - Received Data	412,080	Reset Data
Standard - Transmitted Data	81,408	
Streaming Class Connected Time	Trip Total (Time)	
Streaming - Connected	02: 39: 36	Reset Data
Circuit Switched Connected Time	Trip Total (Time)	
Circuit Switch - Connected	09: 35: 29	Reset Data

Lifetime Usage Statistics

Standard Class Data Transfers	Lifetime Total (MB)	
Standard - Received Data	1055,396	
Standard - Transmitted Data	323,563	
Streaming Class Connected Time	Lifetime Total (Time)	
Streaming - Connected	06: 57: 19	
Circuit Switched Connected Time	Lifetime Total (Time)	
Circuit Switch - Connected	31: 55: 53	

NOTICE

If the UT power is abruptly disconnected for some reason, the UT will not be able to save the statistics to flash and hence the statistics for the session (**Trip**) may be inaccurate.

Support Page

This web page allows you to display technical and support information about the terminal and retrieve logs.

HUGHES Home Connections SMS Settings M2M Usage Support

9450 Support and Information

STATUS

Connection

Registered
PS Attached
CS Attached

Beam: REGIONAL 13
Signal Strength: 58.3
40

GPS

2D GPS Fix

Location: 32.89647° N
117.20168° W
Last Fix: 08-Jun-2015,
21:57 UTC

BGAN Terminal

WLAN Disabled

Antenna Unit

Tracking
Elevation 46°
1537.070 MHz

Terminal Information

Model	BGAN USER TERMINAL, Hughes 9450, Ver 1
Class	10
IMEI	353937-03-101110-5
Software Version	5.7.2.3

SIM Information

IMSI	901112112559675
APN	bgan.inmarsat.com
Subscriber Phone Number	Not configured by Service Provider.

Terminal Support

Website	www.inmarsat.com
Telephone	+442077281020
E-mail	customer.care@inmarsat.com

Troubleshooting

Terminal Logs

Log Type	Current Log	Archived Log	Reset Log
To download the logs to disk, Click or right-click the links below and select 'Save Target As'.			
System Log	Download Current		
Event Log	Download Current	Download Archive	<input type="button" value="Reset Event Log"/>
Packet Log	Download Current	Not Available	<input type="button" value="Reset Packet Log"/>
Circuit Log	Download Current	Download Archive	<input type="button" value="Reset Circuit Log"/>

Reset Terminal to Factory Defaults

Click this button to restore all terminal settings to their original default values.

Reboot Terminal

Click this button to reboot the terminal software.

Support and Information

Terminal Information

Model: this displays the UT model number.

Class: this indicates the UT Class, such as Class 11 for a land mobile terminal or Class 10 for high gain land mobile terminal.

IMEI: This displays the IMEI (serial) number of the UT.

Software Version: This displays the current version of software that is running on the UT.

SIM Information

IMSI: This displays the IMSI number of the SIM card in the UT. If the IMSI is not displayed, it indicates that there is a problem reading the SIM card, e.g. because there is no SIM, it is installed incorrectly or PIN must be entered.

APN: This is read directly from the SIM card.

Subscriber Phone Number: this field displays the MSISDN or phone number for the terminal's voice service. The number is only displayed if the number was configured in the SIM by your service provider. Even if no number is shown, the service may still be active because this field is just for your information and is not required for the service to operate.

Terminal Support – contact information retrieved from the SIM card.

Website
Telephone
E-Mail

Troubleshooting

Terminal Log Files: This allows you to extract and save any of the following log files for troubleshooting purposes:

System Log
Event Log – Current and Archived
Packet Log – Current and Archived
Circuit Log – Current and archived

These files can be e-mailed to Hughes directly for fault analysis if the user experiences any problems.

Note that downloading these files does not work with Chrome. Use IE, Edge, Firefox or Safari.

NOTICE

The system log is stored in volatile memory and so when capturing a log of a problem, the problem must be reproduced and then the log extracted without power cycling the terminal.

Reset Terminal to Factory Defaults: Clicking the “Restore to Defaults” button will restore the UT back to the factory default settings and delete any of the user parameters that have been set-up in the UT.

NOTICE

Hughes highly recommends that the user exhaust all possible troubleshooting procedures before using this feature

Reboot terminal: Clicking this button reboots the terminal so that configuration changes can be saved into the configuration file or can be used when just a simple reboot of the terminal is required.

Troubleshooting

Problem	Possible Cause	Possible Solution
Terminal will not turn on	<p>Power switch not on</p> <p>No ignition sense</p> <p>Fuse is blown</p>	<p>Check the power switch is in the ON position and LED is on</p> <p>Check positive voltage is applied to the ignition sense pin of the power connector</p> <p>Remove fuse and check.</p> <p>Refer to Installation Manual</p>
Cannot get SIM card to lock into position	SIM is not correctly oriented for insertion	<p>Ensure the SIM is pressed firmly into the SIM slot</p> <p>Ensure the SIM is oriented as shown in on the terminal and in the Install Guide</p>
The BGAN LaunchPad or web UI will not connect to the terminal	<p>No interface connection between the terminal and computer</p> <p>Your computer is configured with a static IP address in the wrong subnet. Default UT IP address is: 192.168.128.100</p> <p>UT is in M2M mode</p>	<p>Ensure there is a WLAN or Ethernet connection between the terminal and computer.</p> <p>Check the IP configuration settings on your computer.</p> <p>Enable DHCP or use a static IP address in the same subnet as the UT local IP address. Default UT IP address is: 192.168.128.100</p> <p>LaunchPad is not supported in M2M mode.</p>
Terminal will not accept incoming ISDN calls	The MSN programmed into the ISDN device does not match the MSN programmed into the terminal	<p>Ensure the appropriate MSN is programmed into the ISDN device, see User Guide for the ISDN device</p> <p>Ensure the appropriate MSN is programmed into the terminal, see ISDN Section of User Guide</p>

Problem	Possible Cause	Possible Solution
Terminal will not make outgoing ISDN calls	<p>ISDN power sourcing is turned off</p> <p>Terminal is not Registered with the Network.</p> <p>Elevation angle is too low for ISDN service</p>	<p>Enable the ISDN power sourcing from the BGAN LaunchPad or ISDN web UI page (unless the ISDN device has a separate power source).</p> <p>Check the Properties page in web UI to make sure the unit is CS attached.</p> <p>Refer to page 9 for ISDN service restrictions.</p>
ISDN device does not operate correctly	<p>The ISDN device is trying to draw too much power from the satellite terminal's ISDN interface</p> <p>The device you are connecting is not an ISDN device. It might be an Ethernet device that you are accidentally connecting to the ISDN port.</p> <p>Make sure that you don't have both RJ11 and ISDN handsets connected at the same time.</p>	<p>Only connect an ISDN device that draws less than 70mA of current at 40V (equivalent power 2.8W)</p> <p>Make sure you connect only ISDN devices to the ISDN port</p> <p>Remove one of the handsets and reboot the terminal.</p>
Cannot make fax calls	Elevation angle is too low for fax (3.1KHz audio) service	Refer to page 10 for service restrictions.
Terminal is connected to the BGAN network, but cannot obtain the requested Quality of Service	<p>Network temporarily not available</p> <p>User tried to set up a 256 Kbps streaming connection.</p>	<p>Retry again. If problem persists, contact your service provider.</p> <p>The Inmarsat Network only supports 256K for Class 10 > 45 degree look angle and 128K connections for Class 11 UT's</p>
Terminal does not obtain a GPS fix	Terminal's location limits visibility of 3 or more GPS satellites.	Move the vehicle / terminal to a location where there are few obstructions such as trees or tall buildings, so that as much as possible of the sky is visible.
None of the above solutions resolve the problem	Terminal may have a hardware or software fault, and needs to be re-booted.	Remove power. Wait 30 seconds. Reconnect the DC power and turn on the terminal.

PDP Context Activation Errors

CME error number	CME Error Text on Web UI	Possible reason
14	invalid index	Problem in PDP context request
21	no network service	Could be poor signal or signal blockage, or network problem.
55	Implicitly detached (#10)	Check attach and registration status.
62	Network failure (#17)	Could be problem accessing the network; or could be invalid streaming rate or too many streams requested.
65	Congestion (#22)	Insufficient resources in the spot beam. Retry later.
67	Service option not supported (#32)	Invalid context parameters or subscription problem.
68	Requested service option not subscribed (#33)	Requested invalid APN or SIM subscription problem.
69	Service option temporarily out of order (#34)	Retry activating the context, then try rebooting the unit.
70	No PDP context activated (#40)	Retry activating the context, then try rebooting the unit.
72	PDP authentication failure	Could be invalid APN username or password
74	Semantically incorrect message (#95)	Could be problem in TFT definition or PDP context request.
75	Invalid mandatory information (#96)	Problem in PDP context request
76	Message type non-existent or not implemented (#97)	Problem in PDP context request
77	Message type not compatible with the protocol state (#98)	Problem in PDP context request
78	Information element non-existent or not implemented (#99)	Problem in PDP context request
79	Conditional IE error (#100)	Problem in PDP context request
80	Message not compatible with the protocol state (#101)	Problem in PDP context request
81	Protocol error, unspecified (#111)	Problem in PDP context request
92	Network access forbidden	Retry activating the context, then try rebooting the unit. Check the SIM card and SIM subscription.

Technology Overview

GPS

The Global Positioning System (GPS) uses 24 orbital satellites to determine the position of the Terminal anywhere on the globe.

Obtaining a GPS Fix

In normal operation, a GPS receiver, such as that built in to the Tracking Antenna, needs to be able to receive signals from at least four satellites so that it can then calculate a latitude, a longitude and an altitude – this position fix is referred to as a 3-dimensional or 3-D fix. If only three GPS satellites can be seen by the GPS receiver, then the last available altitude measurement is assumed and the GPS receiver calculates a position fix based on latitude and longitude only. This simpler position fix is referred to as a 2-dimensional or 2-D fix and is quicker and easier to obtain than a 3-D fix, but may be less accurate.

The GPS receiver may take between a few seconds and a few minutes to obtain a GPS fix, depending on how frequently the GPS receiver is being used. The frequency of use determines the how quickly the GPS Terminal is able to start.

- Hot start – if the GPS receiver is being used frequently, (that is, in the last two hours), it is regularly updated with data from the GPS satellites, and so only takes a few seconds to obtain a GPS fix after being switched on.
- Warm start – if a GPS receiver has not been used for more than two hours then it will take up to 45 seconds to obtain a GPS fix.
- Cold start – if the GPS receiver has not been used for some time or is 300 km or more from where it was last used, it can take as long as 15 minutes to obtain a valid position fix.

The time taken to obtain a valid GPS fix can also be affected by the visibility that the GPS receiver has of the GPS satellites. The GPS system is relatively tolerant of atmospheric conditions such as heavy cloud or rainfall. However, physical blockages, such as tall buildings or terrain can significantly degrade the ability of the GPS receiver to obtain a fix. For this reason, ensure that the GPS receiver has a clear view of as much open sky as possible.

GPS and BGAN Registration

BGAN uses the accurate position and timing information obtained from GPS to help ensure efficient registration of a BGAN Terminal with the BGAN network.

ISDN

The Satellite Terminal provides an ISDN (Integrated Services Digital Network) interface to connect devices for Circuit Switched voice and data services. It is a Basic Rate (also known as 2B+D) interface and uses the Euro ISDN protocol. Note that the Satellite Terminal can only provide service for one 64Kbps B-channel at a time.

Dialing and Numbering

Dialing - As the ISDN numbering system follows the same pattern as the normal telephone system, dialing is carried out in exactly the same manner as making a normal telephone call. The subscriber number is used with the same international and area codes as any other telephone network. Start the dialed number with 00 and terminate it with a #.

Multi-Subscriber Numbering (MSN) - ISDN supports Multi-Subscriber Numbering (MSN). MSN is a facility whereby more than one telephone number can be allocated to an ISDN line. The BGAN Satellite Terminal assigns different MSNs for Voice, 3.1KHz Audio, UDI and RDI devices. Each incoming call will be directed to the appropriate MSN depending on the type of call. This allows proper routing of incoming calls to the correct ISDN device (e.g. ISDN phone, data card or Fax).

PDP Context

A Packet Data Protocol (PDP) Context defines connection aspects such as routing, Quality of Service (QoS), security and billing between a mobile user terminal, such as the BGAN Terminal, and a data network. PDP Contexts are essential to the General Packet Radio Service (GPRS) system, which is used by GSM and UMTS-based 3G networks worldwide for transmitting data.

In order for a user to be able to transfer data across a network, a PDP Context must be activated in the Terminal and associated Core Network. The procedure for this is as follows:

1. After registration with the network, the user activates a PDP Context using an application on the computer or Terminal, and requests sufficient radio resources (that is, power and bandwidth) to support the context activation procedure.
2. Once the resources are allocated, the Terminal sends the Activate PDP Context request to the Core Network. This request includes key information about the mobile user's PDP address (for example an IP address), PDP type (that is, static or dynamic address) the QoS requested for this context, the APN of the external network to which connectivity is requested, the user's identity (IMSI) and any necessary IP configuration parameters (for example, security settings).
3. On receiving the Activate PDP Context message, the Core Network checks the user's subscription record to establish whether the request is valid. If the request is valid, a virtual connection is established between the Terminal and the Core Network, and data transfer can then take place between the Terminal and the external data network, within the scope of the current PDP Context. The PDP Context is stored in both the Terminal and the Core Network.

A single Terminal may have multiple PDP Contexts each with different QoS profiles. The primary PDP Context is a PDP Context with default QoS profile attributes and is always activated first. All other PDP Contexts with the same PDP Address are secondary PDP Contexts. Secondary PDP Contexts share the same PDP Address and connect to the same APN but may have different QoS profiles.

Technical Specifications

	Terminal	C10 Antenna	C11 Antenna
Weight	2.3 Kg	5.50 Kg	2.0 Kg
Dimensions	46mm x 281mm x 234mm	Ø494mm x 152mm	Ø252 mm x 119 mm
Humidity	95% RH at +40°C	95% RH at +40° C	95% RH at +40° C
Temperature	-25°C to +55°C operating -25°C to +80°C storage	-25° C to +55° C operating -25° C to +80° C survival	-25° C to +55° C operating -25° C to +80° C survival
Water & Dust		IP-56 standard	IP-56 standard
Wind	N/A	125 mph (200 km/h) Exception for Magnetic Mount: 100 mph (160 km/h)	125 mph (200 km/h) Exception for Magnetic Mount: 100 mph (160 km/h)
ICE	N/A	25 mm non-operational	25 mm non-operational
Vehicle Motions	N/A	Turning Rate: 40°/s Turning acceleration 50°/s ²	Turning Rate: 40°/s Turning acceleration 50°/s ²
Power (terminal plus antenna)	*Idle: 32 W Max: 65 W (when transmitting)		

***Note:** This does not include power delivered to any PoE devices connected.

EU Declaration of Conformity

We,

Hughes Network Systems

of

9605 Scranton Road, Suite 500, San Diego, CA 92121, USA

hereby declare under our sole responsibility that the product

Land Mobile BGAN Terminal, Models 9450E, 9450L

is in conformity with the following standards and/or other normative documents.

All essential radio test suites have been carried out, and the product is in conformity with the essential requirements of Radio Equipment Directive (RED) 2014/53/EU.

For article 3.1(a), Health and Safety of the User:

EN 62311:2008

EN 60950-1:2006/A2:2013

IEC 60950-1:2005/AMD2:2013

For article 3.1(b), Electromagnetic Compatibility:

EN 301 489-1 V2.1.1 (2017-02)

EN 301 489-20 V1.2.1 (2002-11)

For article 3.2, Effective Use of the Spectrum Allocated:

EN 301 444 V2.1.2 (2016-11)

RoHS-2 Directive 2011/65/EU

The European Union (EU) Restriction of Hazardous Substances (RoHS) Directive 2011/65/EU restricts the use of certain hazardous substances in electrical and electronic equipment.

Unless otherwise noted, all products, assemblies, and sub-assemblies manufactured by Hughes and its sub-contractors are compliant with this directive.

Identification mark:

CE

The technical documentation relevant to the above equipment is held at:

Hughes Network Systems, 9605 Scranton Road, Suite 500, San Diego, CA 92121, USA

Bill Lindsay

Senior Engineering Program Director



14-MAR-18

FCC Compliance

- This device conforms to the FCC rules. Any changes or modifications to Hughes Network Systems' equipment, not expressly approved by Hughes Network Systems, could void the user's authority to operate the equipment.
- To comply with FCC RF exposure requirements, this device must be operated with a minimum separation distance of 20 cm or more from a person's body. Other operating configurations should be avoided.
- This device complies with Part 15 of the FCC Rules. Operation is subject to the following two conditions; (1) this device may not cause harmful interference, and (2) this device must accept any interference received, including interference that may cause undesired operation.

EU RoHS-2 (Restriction of Hazardous Substances) Directive

The European Union (EU) Directive 2011/65/EU restricts the use of certain hazardous substances in electrical and electronic equipment.

Unless otherwise noted, all products, assemblies, and sub-assemblies manufactured by Hughes and its sub-contractors are compliant with this directive.

EU WEEE (Waste Electrical and Electronic Equipment) Directives

The European Union (EU) directive on waste electrical and electronic equipment mandates recycling of electrical and electronic equipment throughout the EU by August 13, 2005.

Unless otherwise noted, all products, assemblies, and sub-assemblies manufactured by Hughes and its sub-contractors will be compliant with this directive and any subsequent revisions or amendments. This product carries the WEEE label below to demonstrate compliance.

For addition information, contact Hughes Network Systems at:
www.hughes.com.



Glossary

APN: An Access Point Name (APN) provides access to an external network. By default, the SIM Card in your terminal is configured with the APN of your Service Provider. You may want to configure further APN's if you have arranged with your Service Provider to use more than one SIM Card.

BGAN Satellite Terminal: Referenced throughout this document as the Satellite Terminal, "The Terminal," or UT. This device implements and manages BGAN satellite communications between your computer and Service Provider's network.

Quality of Service: Quality of Service (QoS) assigns a level of priority to certain types of data traffic, in particular high bandwidth applications such as video and multimedia. QoS attempts to maintain a guaranteed throughput level, and minimize error rates and end to end latency, so providing a higher level of service than "best effort" protocols.

DNS Server: The Domain Name System (DNS) is an Internet service that is required because the Internet does not recognize the text-based Web address or email address that you type into your Web browser or email application. All or part of a Web address or an email address is a domain name, and DNS translates this domain name into an IP address that is recognized by the Internet.

A DNS Server holds a database of domain names and IP addresses, so that when you enter a Web address or email address, you are directed to the correct IP address over the Internet.

Ethernet: Ethernet is a local area networking method used widely throughout the computer industry. It is one of the three communications interfaces supported by the Satellite Terminal.

Fault Code: A number which uniquely references an error in a hardware or software system. In the Satellite Terminal, if there is a fault detected, the fault code and a description are displayed in suitable LaunchPad windows.

GPS: Global Positioning System. The GPS receiver in the Satellite Terminal receives signals from the constellation of GPS satellites. It uses these signals to determine the Terminal's location on earth. That location is used during registration to gain access to the BGAN system.

IP Address: An Internet Protocol address, or IP address, is a number that uniquely identifies the computer accessible over a TCP/IP-based LAN or the Internet that is sending or receiving information. An IP address is a 32-bit numeric address written as four numbers, separated by periods and each number is between 0 and 255. For example, 207.115.79.4 is an IP address. In the BGAN system, IP addresses for the Network and the TE can be dynamic or static.

Network Dynamic IP Address: A network dynamic IP address is a temporary address that is assigned by your BGAN Service Provider when you connect to the BGAN Network.

Network Static IP Address: If required, a static IP address can be assigned by Service Providers to BGAN users when the SIM is provisioned. This static IP address is used every time you connect to the BGAN network and is associated with a specific username and password.

DHCP Address: Local IP address that is assigned by the UT DHCP server to the TE once connected to the UT. This is a private IP address that is not routable within the Internet.

Terminal Local IP Address: IP address of the UT to access the web UI and talk to the UT via LaunchPad. This address is configurable by the user. The default local IP address of the terminal is 192.168.128.100

Power-over-Ethernet (POE): Connection that provides power through an Ethernet cable.

Standard Connection: A standard connection is charged by volume of data sent. The bandwidth you are allocated depends on terminal type and network availability, but is always 'best effort', that is, you are allocated bandwidth depending on your requirements and the requirements of other users of the BGAN network, or BGAN Terminal. This connection class is suitable for most data types, other than multimedia.

Streaming: A streaming connection gives you a guaranteed data rate and is charged by the amount of time the connection is active. Streams are typically used for multimedia data, such as video.

TE (Terminal Equipment): Terminal equipment refers to the piece of equipment that is connected to the BGAN UT (e.g. laptop, video equipment, phone, etc.)

Traffic Flow Template: A Traffic Flow Template, also called an Application Template, is a series of data filters such as QoS (Quality of Service), PDP Context and security settings, that allow the Core Network to classify packets received from an external network into the correct PDP Context. When incoming

data arrives at an access point in the core network, a packet classifier will make a PDP Context selection based on the Traffic Flow Template, and map the incoming data packets into the PDP Context with the correct QoS attributes. The use of a Traffic Flow Template allows multiple PDP Contexts to be associated with the same PDP address.

UT (User Terminal): The user terminal is the BGAN modem device, i.e. the Hughes 9450.

SIM Card: Your BGAN Service Provider supplies you with a Universal Mobile Telecommunications System Subscriber SIM (SIM) Card.

The SIM card is similar to the SIM Card that is commonly used in a GSM phone. The card holds a microchip that stores information and encrypts voice and data transmissions, making it extremely difficult to listen in on calls. The SIM Card also stores data that identifies the caller to the BGAN Service Provider.

Virtual Private Network: A Virtual Private Network (VPN) enables remote offices or users to gain secure access to their organization's network over the public telecommunications network. This provides the benefits of remote access without the expense of dedicated leased or owned lines. VPNs work by using tunneling protocols, to encrypt data at the sending end, and decrypt the data at the receiving end. This "tunnel" cannot be accessed by data that is not properly encrypted.