

KVH Industries, Inc.

TracPhone® V7HTS

with Integrated CommBox Modem (ICM)



User's Guide

TracPhone V7-HTS

User's Guide

This user's guide provides all of the basic information you need to operate, set up, troubleshoot, and maintain the TracPhone V7-HTS system. For detailed installation information, please refer to the TracPhone V7-HTS Installation Guide.

If you have any comments regarding this manual, please email them to manuals@kvh.com. Your input is greatly appreciated!



Technical Support

Within the Continental U.S.A.:

Phone: 1 866 701-7103

Email: mvbsupport@kvh.com

North/South America, Australia:

Phone: +1 401 851-3806

Email: mvbsupport@kvh.com

Europe, Middle East, Asia, Africa:

Phone: +45 45 160 180

Email: mvbsupport@kvh.com



Trademark Information

TracPhone, KVH, CommBox, IP-MobileCast, and the unique light-colored dome with dark contrasting baseplate (Reg. No. 2,864,752) are trademarks of KVH Industries, Inc. mini-VSAT Broadband is a service mark of KVH Industries, Inc.

All other trademarks are the property of their respective owners.

Disclaimer

Every effort has been made to ensure the correctness and completeness of the material in this document. No company shall be liable for errors contained herein. The information in this document is subject to change without notice. No warranty of any kind is made with regard to this material, including, but not limited to, the implied warranties of merchantability and fitness for a particular purpose.

Table of Contents

1 Introduction

About this Manual.....	3
Who Should Use this Manual.....	3
Icons Used in this Manual	3
Related Documentation.....	4
Important Safety Information.....	5
RF Radiation Hazard Area	6
System Overview.....	7
System Components	8
Satellite Communications.....	9
Seamless Satellite Switching.....	11

2 Getting Started

Service Activation.....	15
Contacting the Airtime Services Department.....	15
Turning On the System	16
System Startup.....	17
Accessing the Web Interface.....	18
Understanding the Home Page.....	19
Accessing the mini-VSAT Manager at myKVH.....	20
Viewing the Help (User Documentation).....	21
Clearing the Cache of Your Web Browser	22

3	Interface Preferences	
	Changing the Administrator Password	25
	Entering the Vessel Name.....	26
	Assigning Phone Line Names	27
	Adjusting the LCD Brightness	28
4	No-Transmit Zones	
	No-Transmit Zones Overview.....	31
	Status of No-Transmit Zones	32
	Establishing No-Transmit Zones.....	33
	Disabling No-Transmit Zones.....	38
	Clearing No-Transmit Zones	39
5	Tracking Avoidance Zones	
	Tracking Avoidance Zones Overview	43
	Setting Up Tracking Avoidance Zones	44
	Disabling Tracking Avoidance Zones	50
	Clearing Tracking Avoidance Zones.....	51
6	Voice Connections	
	Voice Service Overview.....	55
	How the Voice Service Works.....	55
	Making a Ship-to-Shore Call.....	56
	Making a Shore-to-Ship Call.....	58
	Adding Phone Lines	59
	Additional MTA(s)	60
	Crew Calling Gateway.....	61
	Virtual Numbers	62

VoiceMail	63
Recording a VoiceMail Personal Greeting	63
Listening to Your VoiceMail Messages.....	63
Faxing	65
UCH-250 Fax Server	66
Accessing Your Voice Account	67
7 Network Configuration	
Selecting a Network Configuration.....	71
Standard HTS Configuration	74
Static IP HTS Configuration.....	77
Open Access HTS Configuration	81
Compatible Configurations for Media Server.....	82
Wireless Settings.....	83
Configuring Computers for DHCP.....	85
Windows 10 DHCP Settings.....	85
Windows 8 DHCP Settings.....	86
Windows 7 or Windows Vista DHCP Settings	87
Windows XP DHCP Settings	88
Mac OS X DHCP Settings.....	90
LAN Settings	91
Cache Settings.....	92
Setting Up Data Usage Alerts.....	93
CommBox Settings	94
Reset to Factory Configuration	95
8 Data Connections	
Internet Access Overview	99
Connecting to the Internet.....	100
Tips for Minimizing Data Usage.....	101

Preventing Automatic Updates	102
Disabling Automatic File Backup and Synchronization	102
Firewall Protection	103
Web Browser Settings	103
Data-Intensive Applications.....	104
Mobile Websites	104
Disabling Wi-Fi Access on Mobile Devices.....	104
Email Best Practices.....	105
CommBox Features.....	106
Accessing the CommBox Web Interface.....	107
KVH Link Content Services.....	108
Accessing KVH Link Content.....	109
Accessing KVH Link Documentation.....	111

9 Troubleshooting

Initial Steps for Any Problem	115
Troubleshooting a Voice Problem	117
Troubleshooting a Data Problem.....	119
Error and Warning Messages.....	121
Status Information	126
Status Information on the Web Interface.....	126
Status Information on the ICM Front Panel LCD	132
LED Indicators.....	136
System Logs	138
Operational Log	138
Event Log.....	139
Equipment ID Numbers	140
Software Versions.....	141

OneCare Customer Support	142
Contacting KVH Technical Support.....	143
Remote Diagnostics	144
10 Maintenance	
Preventative Maintenance	147
Software Updates	149
Using the ICM to Update Software	150
Using Your Computer to Update Software.....	151
Using an iPhone/iPod touch to Update Software.....	152
Using a USB Flash Drive to Update Software	153
Corrective Maintenance.....	154
Hardware Restart	155
A Wiring Diagram	
Wiring Diagram.....	159
B LCD Menus	
LCD Menus Quick Reference Guide	163
C Specifications	
System Specifications	167
D Glossary	
Glossary	171
E Index	
Index.....	185



1. Introduction

This section provides important safety information you need to know before using the system. It also provides a basic overview of the system and satellite communications.

Contents

About this Manual.....	3
Important Safety Information	5
System Overview	7
Satellite Communications.....	9



About this Manual

This manual provides complete operation, configuration, and troubleshooting information for the TracPhone V7-HTS system.

Who Should Use this Manual

The **user** should refer to this manual to learn how to operate the system, configure all aspects of the system, and identify the cause of any problem.

The **installer** should refer to this manual for information on setting up the system for the user's desired preferences.

The **servicing technician** should refer to this manual to help identify the cause of a system problem.

Icons Used in this Manual

This manual uses the following icon:

Icon	Description
	This is a danger, warning, or caution notice. Be sure to read these carefully to avoid injury!

Typographical Conventions

This manual uses the following typographical conventions:

Text Example	Description
Press MENUS to view the menu.	Name of ICM buttons
At the confirmation message, click Save .	Element of a graphical user interface
SELECT SATELLITES	Text as it appears on the ICM display
See "Using this Manual" on page 3 .	Cross-reference to another chapter in the manual
Visit www.kvh.com/mvbservice for details.	Cross-reference to a website

Related Documentation

In addition to this User's Guide, the following documents are provided with your TracPhone system:

Document	Description
Installation Guide	Complete installation instructions
Quick Start Guide	Handy quick reference guide with basic operating instructions
Activation Checklist	Details on activating the system for mini-VSAT Broadband service
Installation Checklist	Form that the installer must return to validate the quality of the installation
Modem Commissioning Checklist	Form that the installer must complete before calling KVH Technical Support to commission the modem, if necessary.
Antenna Mounting Template	Template that the installer uses to lay out the antenna mounting holes
Warranty Statement	Warranty terms and conditions
Kitpack Contents List	List of every part supplied in the kit

Important Safety Information

For your own safety, and for the safety of your passengers and/or crew, be sure to read the following important notices.



WARNING

Risk of Electric Shock

Potentially lethal voltages are present within the ICM. To avoid electric shock, do not open the chassis enclosure.



WARNING

Risk of Electric Shock

If any component of the TracPhone system becomes damaged and/or no longer functions normally, disconnect it from vessel power, secure it from unintended operation, and contact KVH Technical Support (see [“Contacting KVH Technical Support”](#) on page 143). All repairs or modifications must be performed by a trained, KVH-certified technician.



WARNING

Risk of Explosion

Do not operate the ICM (or any other electrical device) in an environment where flammable gases, vapors, or dusts are present.



WARNING

Risk of Electric Shock

Failure to ground the TracPhone system properly to ship's ground will cause an unsafe floating ground condition, risking potentially lethal electric shock. Refer to the Installation Guide for details on the proper grounding of the equipment.



CAUTION

RF Radiation Hazard

The antenna transmits up to 4 watts of radio frequency (RF) energy that is potentially harmful. Whenever the system is powered on, make sure everyone stays more than 36 feet (11 m) away from the antenna. No hazard exists directly below the antenna.

RF Radiation Hazard Area

Since a person above deck may not know which direction the antenna is pointing, you should always observe the minimum safe distance to prevent RF radiation exposure. Within the antenna's elevation range, the minimum safe distance is 36 feet (11 m). No hazard exists directly below the antenna.

Figure 1-1 Minimum Safe Distance to Avoid Risk of RF Radiation Exposure

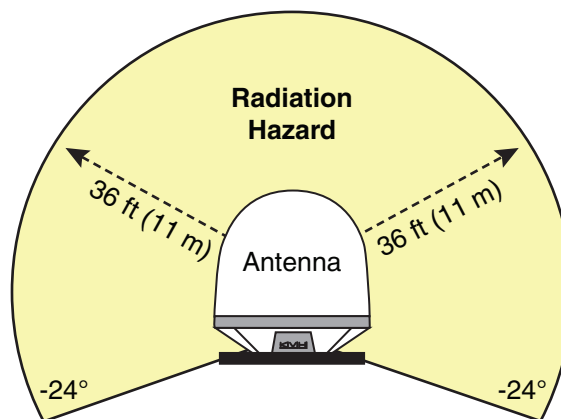

NOTE: You can set up no-transmit zones to inhibit transmissions within areas frequented by passengers and/or crew. See [“Establishing No-Transmit Zones”](#) on page 33 for details.

System Overview

Your TracPhone V7-HTS is a complete mini-VSAT Broadband communications system for mariners on the move, delivering a seamless and consistent Internet experience. And it all comes with an antenna that is smaller and lighter than traditional VSAT antennas.

The system consists of an antenna and Integrated CommBox Modem (ICM) that connect to a land-based hub via a Ku-band satellite. The hub, managed by a Network Operations Center (NOC), then provides the link to the Internet and the terrestrial telephone network.

NOTE: A detailed wiring diagram is provided in "Wiring Diagram" on page 157.

Figure 1-2 TracPhone V7-HTS mini-VSAT Broadband Network Diagram

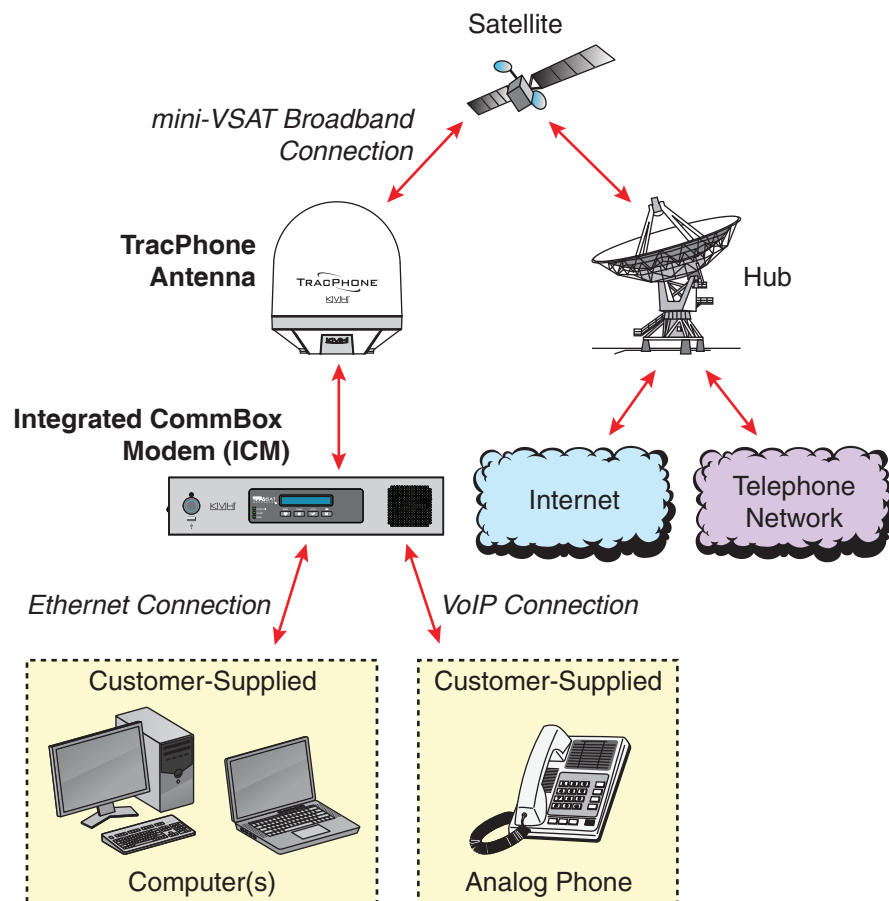

System Components

The TracPhone V7-HTS system includes the following components:

Antenna Unit

The antenna unit provides the satellite link to the land-based hub. Using its integrated GPS, advanced reflector technology, and gyro stabilization, the antenna automatically locates and tracks the correct satellite, even while your vessel is on the move.

Figure 1-3 Antenna Unit

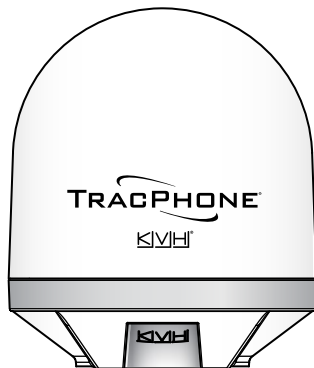

Integrated CommBox Modem (ICM)

The ICM is the transceiver and “brain” of the system. Its built-in modem processes all incoming and outgoing data traffic. Its built-in router and wireless access point (WAP) provide the connection to your onboard local area network (LAN). And its easy-to-use web interface and front panel LCD allow you to operate and configure all aspects of the system.

Figure 1-4 ICM



Satellite Communications

Communications satellites are located in fixed positions above the Earth's equator and relay data to/from the earth within the regions that they serve. Therefore, to communicate via a given satellite, you must be located within that satellite's unique coverage area, also known as its "footprint."

To view the latest mini-VSAT Broadband satellite coverage map, visit KVH's website at www.kvh.com/minivsatmap. The map is an amalgamation of all of the individual satellites' coverage areas.

Figure 1-5 Example of a Satellite Footprint

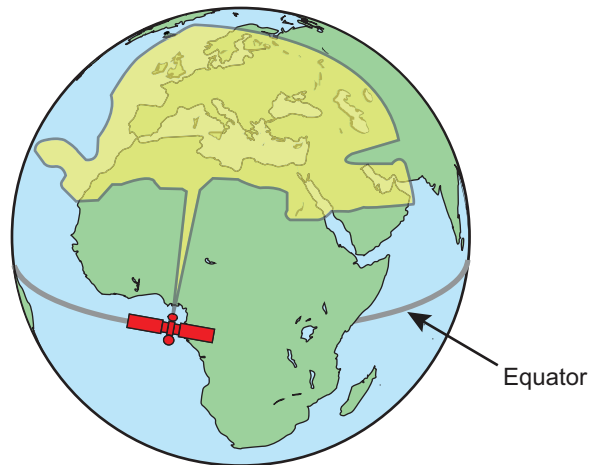

In addition, since satellites are located 22,300 miles (35,900 km) above the equator, the TracPhone antenna must have a clear view of the sky to transmit and receive signals. Anything that stands between the antenna and the satellite can block signals, resulting in lost data.

Common causes of blockage include the following:

- Trees, buildings, and bridges
- Other vessels docked alongside your vessel
- Onboard masts, antennas, or other structures
- Inclement weather conditions

Figure 1-6 Example of Satellite Blockage

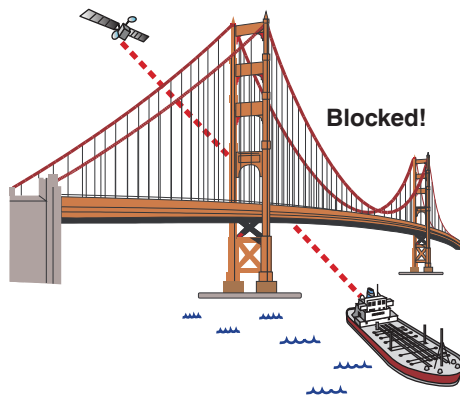

Seamless Satellite Switching

The high-traffic regions of the global mini-VSAT Broadband coverage area are covered by more than one satellite. The ICM's built-in modem maintains a list of all satellites in the network and, with input from the Hub, selects the highest priority satellite that provides coverage at the vessel's current GPS location. If the antenna is unable to track the chosen satellite for any reason (due to a blockage condition, for example), the modem selects the next available satellite on the list and the antenna automatically switches to that satellite.

In addition, whenever the vessel travels outside the boundary of the current satellite's coverage area, with input from the Hub, the modem selects the highest priority satellite in the adjoining region and the antenna automatically switches to that satellite to maintain the service connection.

Figure 1-7 Example of Automatic Satellite Switching

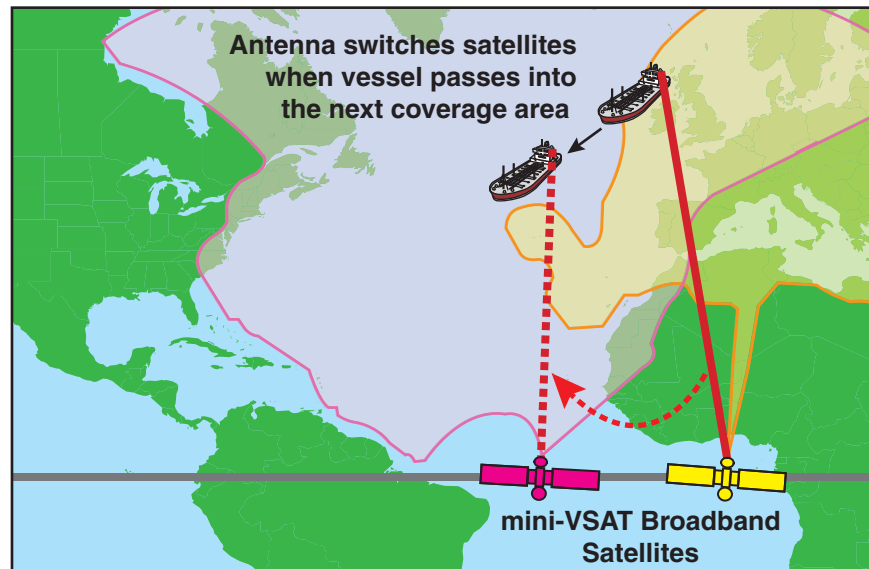

NOTE: The coverage areas shown here are for illustration purposes only. They do not represent boundaries of actual coverage areas.



2. Getting Started

This section provides you with the fundamental things you need to know to start using the system. It explains how to activate the system for mini-VSAT Broadband service, how to turn on the system for the first time, and how to interpret the system's startup screens. It also introduces the TracPhone V7-HTS web interface and myKVH mini-VSAT Manager, and details how to access the Help documentation.

Contents

Service Activation	15
Turning On the System	16
System Startup	17
Accessing the Web Interface	18
Understanding the Home Page	19
Accessing the mini-VSAT Manager at myKVH	20
Viewing the Help (User Documentation)	21



Service Activation

Before you can start using the TracPhone system, you need to activate it for mini-VSAT Broadband service. To activate, fill out and submit the appropriate form(s) available at www.kvh.com/mvbservice.

NOTE: You will need to enter the antenna and ICM serial numbers on the form. You can find these numbers on the Support page of the TracPhone V7-HTS web interface or in the System Info LCD menu on the ICM's front panel. See "Equipment ID Numbers" on page 140.

Fax or email the completed form(s) to KVH:

Fax: +1 401 851-3823

Email: airtimeservices@kvh.com

Once KVH processes the form(s), activates your account, and registers your product, you will receive an email with the details of your new service, including your vessel's phone number(s).

Contacting the Airtime Services Department

If you have any questions, or would like to make a change to your account, please contact KVH's Airtime Services Department via email at airtimeservices@kvh.com or by phone at:

Region	Phone Number
Europe, Middle East, Africa	+45.45.160.197
North & South America	+1 401.851.3862
Asia	+65.31584084
U.S. & Canada	+1.866.399.8509 (toll-free)

Turning On the System

To turn on your TracPhone system, follow these steps:



CAUTION

The antenna transmits RF energy that is potentially harmful. Make sure everyone stays more than 36 feet (11 m) away from the antenna while it is in use. The antenna transmits down to an elevation of -24° , so no hazard exists directly below the antenna.

1. Make sure the antenna has a clear, unobstructed view of the sky.
2. Make sure vessel AC power is applied to the ICM and your computer(s).
3. Press the power button on the front of the ICM. The button's light should illuminate blue.

Figure 2-1 Power Button

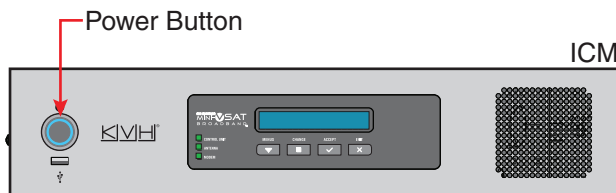

4. Wait at least five minutes for system startup. **Do not turn off the ICM during this time.**
5. Turn on your computer(s) that are connected to the network. Once the antenna finds the service satellite and the ICM's modem logs into the mini-VSAT Broadband service, all status lights on the ICM should be lit green. If any lights are not lit green, refer to [“LED Indicators”](#) on page 136.

System Startup

The ICM shows the following screens during startup. Similar messages will also appear on the web interface. If the display shows an error message, see [“Error and Warning Messages”](#) on page 121.

ICM Screen	Description
ICM INITIALIZING . . . 59	The system is running a self test routine
NO-TRANSMIT ZONE 1 AZ RANGE: 335-025	Displays the azimuth ranges of any user-configured no-transmit zones
ANTENNA READY WAITING FOR MODEM	The antenna is waiting for the ICM's modem to initialize
WAITING FOR GPS	The antenna is waiting for a GPS fix
GPS: ACQUIRED 41.5198N, 123.5817W	When GPS acquires a fix, momentarily displays your latitude/longitude
MODEM COMMS: OK	The ICM's modem is communicating OK
RECEIVING SATELLITE INFO FROM MODEM	The ICM's modem is providing satellite identification data to the antenna
ANTENNA STATE INITIALIZING	The antenna is initializing
SEARCHING FOR 105.0W SATELLITE	The antenna is searching for the mini-VSAT Broadband satellite
RF RADIATION HAZARD! TRANSMIT INHIBITED	If the antenna is pointing within an enabled no-transmit zone, it will not transmit
OFFLINE TRACKING 105.0W	The antenna is now tracking the satellite
ONLINE TRACKING 105.0W	The ICM's modem has accessed the mini-VSAT Broadband service; the system is ready for use!

Accessing the Web Interface

The ICM offers a local web interface, which you can use to check system status, update software, and configure all aspects of the system. To access the web interface, simply open a web browser window on any computer on the network and enter the following web address:

http://minivsat.kvh

NOTE: This web address may not work on all platforms and browsers. It also will not work in certain network configurations. If the web interface does not appear, enter the ICM's IP address instead (default is 192.168.6.1). You can find this address on the ICM front panel LCD (go to Settings > Network Settings > IP Assignments).

As long as the ICM is turned on and functioning properly, the Home page will appear in your browser.

Figure 2-2 Web Interface Home Page



Understanding the Home Page

The Home page of the TracPhone V7-HTS web interface provides essential system status information, including the status of the antenna, the system's connection to the mini-VSAT Broadband service, and the voice service connection. It also displays the vessel's GPS position and true heading and provides a graphical representation of the antenna's pointing direction relative to the bow of the vessel.

Important!

If true heading is not displayed, the TracPhone system does not have a valid connection to the vessel's NMEA 0183 talker.

Figure 2-3 Real-time Vessel & VSAT Satellite Display

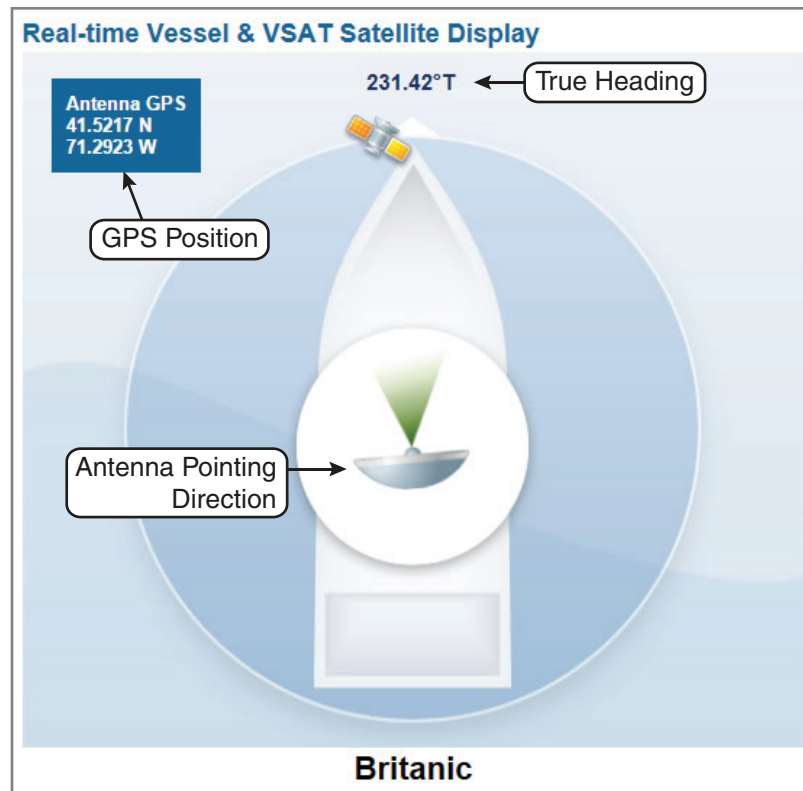

Accessing the mini-VSAT Manager at myKVH

The mini-VSAT Manager at the myKVH secure web portal allows you to manage your vessel's mini-VSAT Broadband usage from anywhere over the Internet. Specifically, the mini-VSAT Manager provides the following services:

- View vessel connection status, location, and data usage
- Set up data usage and overage alerts (see "[Setting Up Data Usage Alerts](#)" on page 93)
- Establish daily, weekly, or monthly data allocations for each user on the vessel
- Block or restrict certain categories of data usage
- Change the ICM's network configuration and Wi-Fi settings (see "[Selecting a Network Configuration](#)" on page 71)
- View the track of the vessel and its historical speed data

NOTE: If you manage a fleet of vessels, you can view and configure each vessel in your fleet.

To access the mini-VSAT Manager, open a web browser on any computer connected to the Internet and enter the following web address:

<https://www.mykvh.com>

Then select mini-VSAT Manager. At the login page, enter your email address and myKVH password (your initial password is provided by KVH's Airtime Services Department).

Figure 2-4 myKVH mini-VSAT Manager (Example)

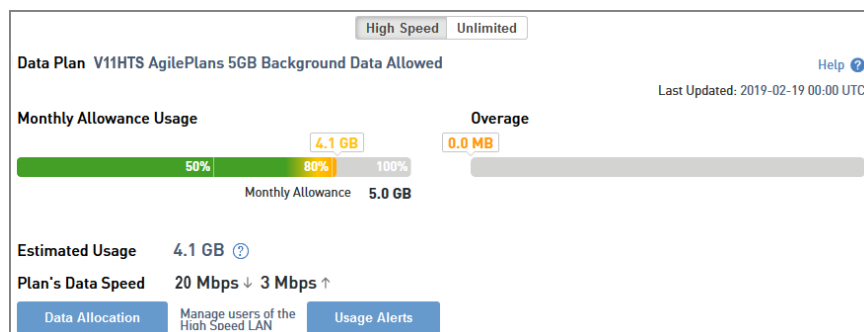

Viewing the Help (User Documentation)

The system's Help is available on the Support page of the TracPhone V7-HTS web interface. Two options are offered: Condensed and Extended. Refer to either of these resources for answers to your operation, configuration, or troubleshooting questions.

Important!

You might need to clear your web browser's cache in order to view the latest version of the Help. See ["Clearing the Cache of Your Web Browser" on page 22](#) for details.

NOTE: The Help is compatible with the following web browsers: Internet Explorer, Mozilla Firefox, Google Chrome, and Apple Safari. If you are using Internet Explorer version 10, you will first need to adjust the width of the Help's navigation pane to view topics due to a known software issue.

Condensed Help

- Resides on the ICM locally
- Text-only format

Extended Help

- Resides on the KVH website (airtime charges may apply)
- Media-rich format, with images

To access either of these resources from the ICM, follow these steps:

1. At the TracPhone V7-HTS web interface, click the **Support** tab.
2. On the **Help** menu, click the desired option.

Figure 2-5 Help Options

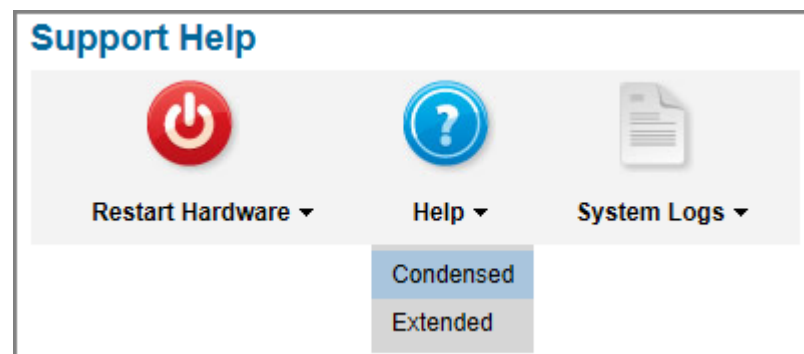

Clearing the Cache of Your Web Browser

When you visit a web page, your browser may store a copy of it in its local cache. As a result, when you revisit the page, the browser may display the old copy it had previously stored rather than reload the latest version from the web. Since the Help actually consists of a set of web pages, you might need to clear your web browser's cache to force it to load the latest version. For example, in Internet Explorer, go to Tools > Safety > Delete Browsing History (or press Ctrl + Shift + Del), select **Temporary Internet files**, then click **Delete**.

Figure 2-6 Clearing the Cache in Internet Explorer

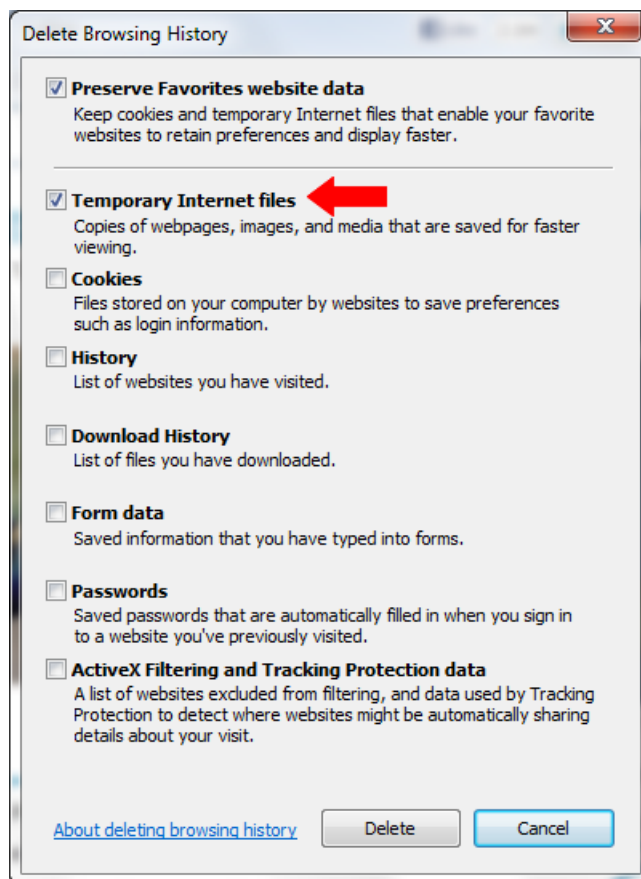



3. Interface Preferences

This section explains how to customize the TracPhone V7-HTS web interface by entering the names of the vessel and phone lines. It also explains how to change the Administrator password and adjust the brightness of the ICM's front panel LCD.

Contents

Changing the Administrator Password	25
Entering the Vessel Name	26
Assigning Phone Line Names	27
Adjusting the LCD Brightness	28



Changing the Administrator Password

You must be logged in as an Administrator to make any substantial changes to the system's configuration on the TracPhone V7-HTS web interface. To prevent unauthorized user access, KVH recommends that you change the Administrator password to something unique.

To change the Administrator password, follow these steps:

1. At the TracPhone V7-HTS web interface, click the **Settings** tab. Then click **Account**.
2. In Security, click **Edit**.
3. Enter the current password. If the password has never been changed, enter the default password: "**password**".

NOTE: The password must be between 4 and 20 characters in length, with at least one letter and one number, case-sensitive.

4. Enter and then re-enter your new password.
5. Click **Save Settings**.

Figure 3-1 Changing the Administrator Password

Security	
Change the administrator's login password.	
Enter the current password:	<input type="password"/>
Enter the new password:	<input type="password"/> <small>(between 4 and 20 characters long, with at least one letter and one number, case sensitive)</small>
Re-enter the new password:	<input type="password"/>
<input type="button" value="Cancel"/> <input type="button" value="Save Settings"/>	

Strong

Entering the Vessel Name

The vessel name is displayed on the Home page of the TracPhone V7-HTS web interface. It also appears in all technical support communications.

To enter your vessel's name in the TracPhone V7-HTS web interface, follow these steps:

1. At the TracPhone V7-HTS web interface, click the **Settings** tab. Then click **Account**.
2. In Vessel Name, click **Edit**.
3. If the Login window appears, log in with the Administrator password.
4. Enter your vessel's name.
5. Click **Save Settings**.

Figure 3-2 Entering the Vessel Name

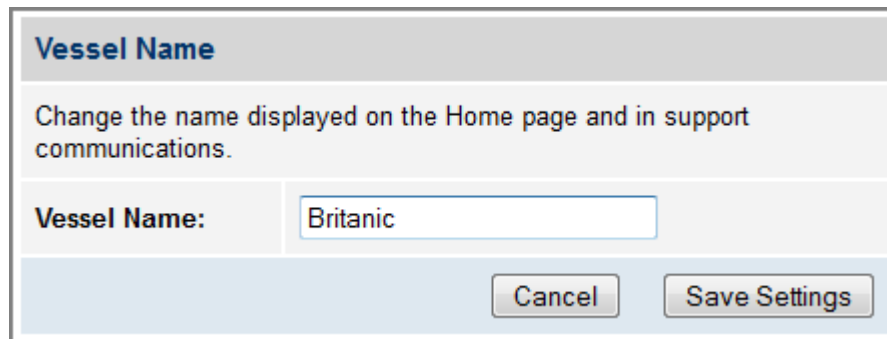

The screenshot shows a web form titled "Vessel Name". Below the title is a descriptive text: "Change the name displayed on the Home page and in support communications." There is a text input field labeled "Vessel Name:" containing the text "Britanic". At the bottom right of the form are two buttons: "Cancel" and "Save Settings".

Assigning Phone Line Names

The phone line names are displayed on the Home page of the TracPhone V7-HTS web interface. They also appear in all technical support communications. For example, you might assign the name "Bridge" to Line 1 and "Crew Quarters" to Line 2 (an additional monthly fee applies to the optional second line).

To assign a name to each phone line, follow these steps:

1. At the TracPhone V7-HTS web interface, click the **Settings** tab. Then click **Other**.
2. In Phone Line Names, click **Edit**.
3. If the Login window appears, log in with the Administrator password.
4. Enter names for Lines 1 and 2.
5. Click **Save**.

Figure 3-3 Assigning Phone Line Names

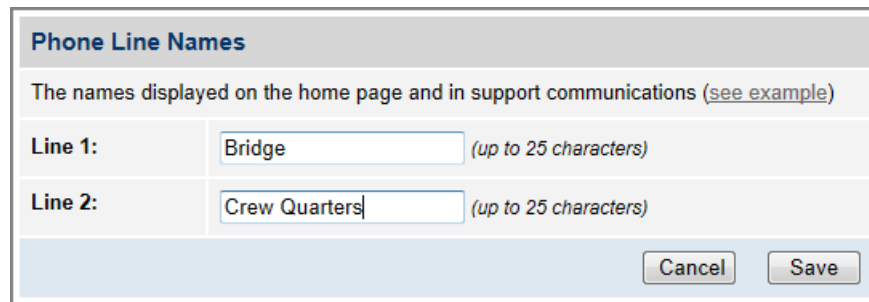

The screenshot shows a web form titled "Phone Line Names". Below the title is a descriptive text: "The names displayed on the home page and in support communications (see example)". There are two input fields: "Line 1:" with the value "Bridge" and "Line 2:" with the value "Crew Quarters". Both fields have a note "(up to 25 characters)". At the bottom right, there are two buttons: "Cancel" and "Save".

Phone Line Names	
The names displayed on the home page and in support communications (see example)	
Line 1:	<input type="text" value="Bridge"/> (up to 25 characters)
Line 2:	<input type="text" value="Crew Quarters"/> (up to 25 characters)
<input type="button" value="Cancel"/> <input type="button" value="Save"/>	

Adjusting the LCD Brightness

You can adjust the brightness of the ICM's front panel LCD to suit your preferences.

To adjust the brightness of the ICM's display, follow these steps:

1. At the ICM front panel, press **MENUS** until the display shows "SETTINGS."
2. Press **ACCEPT**.
3. At "SYSTEM SETTINGS," press **ACCEPT**.
4. At "LCD BRIGHTNESS," press **ACCEPT**.
5. Press **MENUS** until the display shows the desired brightness setting: HIGH, MEDIUM, or LOW.
6. Press **ACCEPT**.
7. Press **EXIT** to exit the menu.

Figure 3-4 LCD Brightness Setting

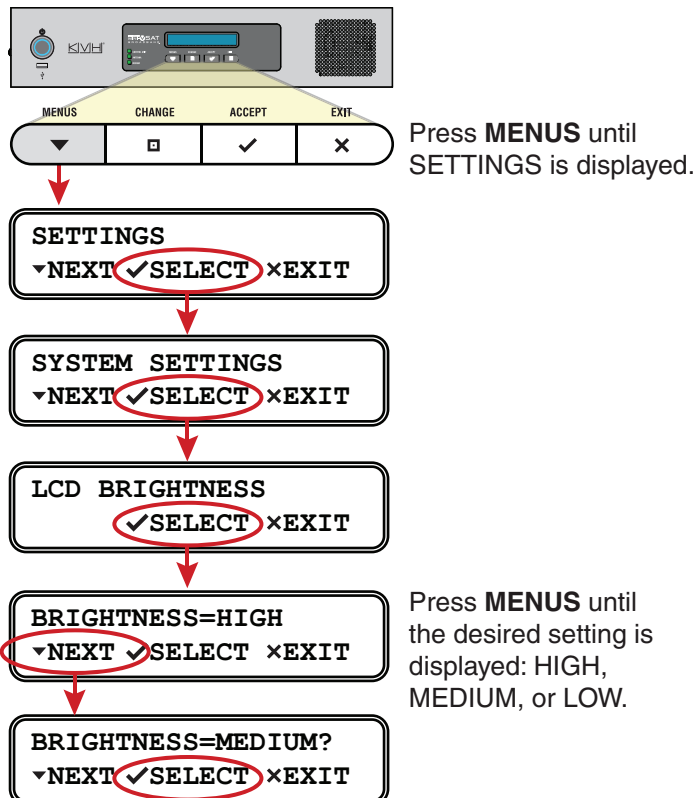



4. No-Transmit Zones

This section explains how to view, configure, temporarily disable, and clear no-transmit zones, which prohibit the antenna from transmitting within a certain azimuth/elevation range.

Contents

No-Transmit Zones Overview	31
Status of No-Transmit Zones.....	32
Establishing No-Transmit Zones.....	33
Disabling No-Transmit Zones	38
Clearing No-Transmit Zones.....	39



No-Transmit Zones Overview

To prevent exposure to the antenna's radiated RF (radio frequency) energy, you can configure up to two no-transmit zones for areas where crew and passengers frequent. Whenever the antenna points within a no-transmit zone, the system disables the transmitter. Transmission capability is restored whenever the antenna points outside the zone.

NOTE: See "RF Radiation Hazard Area" on page 6 for details on the minimum safety distances.

Figure 4-1 Example of a No-Transmit Zone

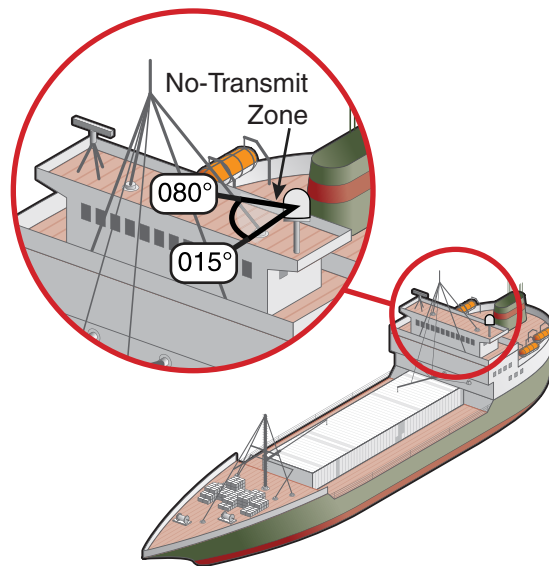

Status of No-Transmit Zones

You can view the current status of the system's no-transmit zones on the Home page of the TracPhone V7-HTS web interface. If no-transmit zones have been set up, "My VSAT Status" includes a No-Transmit Zones column. If this column is missing, no transmit zones have not yet been set up or they have been cleared from memory. See "[Establishing No-Transmit Zones](#)" on page 33 for details on setting up no-transmit zones.

Figure 4-2 No-Transmit Zones Status Information on Home Page

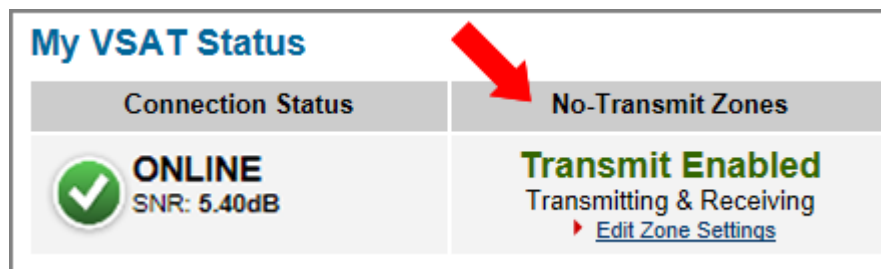

The No-Transmit Zones column will display one of the following status indications:

- **Transmit Enabled (green)** – One or two no-transmit zones have been set up and are currently enforced. However, the antenna is not pointing within a no-transmit zone.
- **Transmit Disabled (orange)** – One or two no-transmit zones have been set up and are currently enforced. The antenna is pointing within a no-transmit zone and will not transmit.
- **Transmit Enabled (red)** – One or two no-transmit zones have been set up, but they are currently being ignored (see "[Disabling No-Transmit Zones](#)" on page 38). The antenna can transmit in any direction without restriction.

NOTE: You can also view the status of no-transmit zones on the ICM's front panel LCD (go to No-Transmit Zones).

Establishing No-Transmit Zones

To configure a no-transmit zone, follow these steps:

1. Identify the necessary azimuth range for the zone (see [“Identify the Azimuth Range”](#)).
2. Identify the necessary elevation range for the zone (see [“Identify the Elevation Range”](#)).
3. At the TracPhone V7-HTS web interface, configure a no-transmit zone for that combination of azimuth and elevation ranges (see [“Configure the No-Transmit Zone\(s\) at the Web Interface”](#) on page 35).

Identify the Azimuth Range

First, you need to determine the necessary azimuth range for the no-transmit zone(s). You will need to enter, in clockwise order, the beginning and ending azimuths that define the outer boundaries of the zone, **relative to the antenna's forward arrow**, which should be pointing toward the bow.

NOTE: Each no-transmit zone must span at least 5°. Therefore, be sure to set beginning and ending azimuths at least 5° apart.

Figure 4-3 Beginning and Ending Azimuths Defining a No-Transmit Zone (Example)

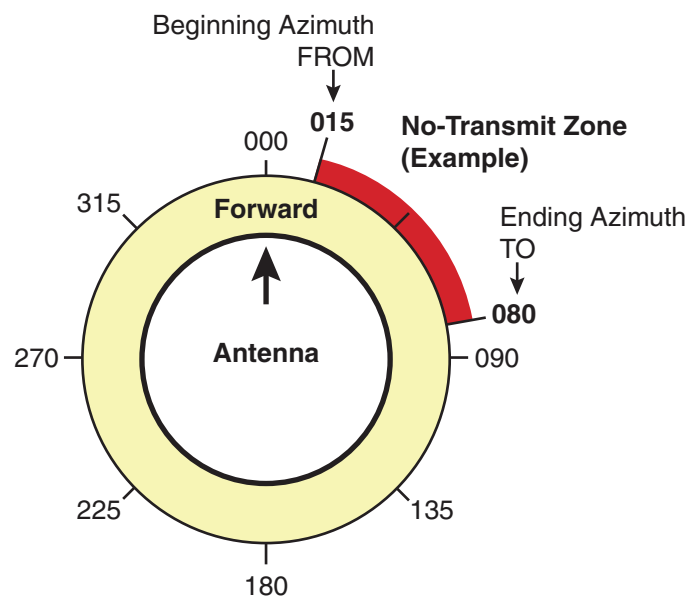

Identify the Elevation Range

Now you need to determine the necessary elevation range for the no-transmit zone(s). You will need to enter, in ascending order, the beginning and ending elevations that define the outer boundaries of the zone.

NOTE: Each no-transmit zone must span at least 5°. Therefore, be sure to set beginning and ending elevations at least 5° apart.

Figure 4-4 Beginning and Ending Elevations Defining a No-Transmit Zone (Example)

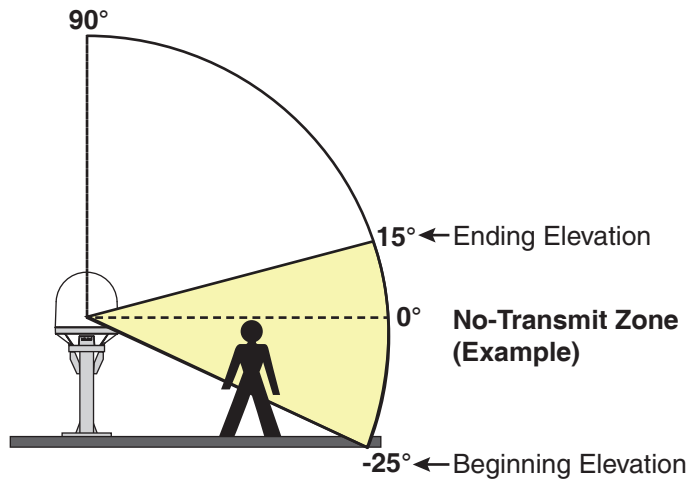



Configure the No-Transmit Zone(s) at the Web Interface

1. At the TracPhone V7-HTS web interface, click the **Settings** tab. Then click **No-Transmit Zones**.
2. Click **Edit**.
3. If the Login window appears, log in with the Administrator password.
4. In No-Transmit Zone Ranges, make sure **Enforce Zones** is selected.

Important!

When “Enforce Zones” is selected, the antenna will not transmit whenever it points within one of your configured no-transmit zones. If “Ignore Zones” is selected instead, the zones are disabled, allowing the antenna to transmit in any direction without restriction.

5. Enter the azimuth and elevation ranges for Zone 1.
6. If you wish to set up a second no-transmit zone, select Zone 2 from the drop-down menu then enter the azimuth and elevation ranges for Zone 2.
7. Click **Save Settings**.
8. At the confirmation message, click **Save**.

Figure 4-5 Configuring No-Transmit Zones

No-Transmit Zone Ranges:

- Enforce Zones**
The antenna will not transmit within the zone(s) specified below.
- Ignore Zones**
The antenna will be able to transmit in any direction without restriction. Be sure everyone stays the minimum safe distance away from the antenna.

Choose a No-Transmit Zone:

Zone 1

Zone 1

Azimuth Range:
Must span at least 5°

From: 15 °
To: 80 °

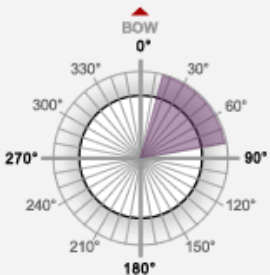

Elevation Range:
Must span at least 5°

From: -25 °
To: 15 °

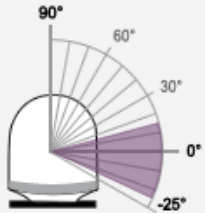

Cancel Clear Zones Save Settings

Understanding the Cumulative View

The No-Transmit Zones page displays a diagram that indicates the cumulative azimuth and elevation ranges of the no-transmit zones you set up. The circumference of the circle indicates azimuth, while the radius indicates elevation.

In the example shown here, the following no-transmit zones are set up:

- Zone 1 (purple) = Azimuth: 170° to 190°, Elevation: -25° to 20°
- Zone 2 (blue) = Azimuth: 15° to 55°, Elevation: 30° to 90°

Figure 4-6 Cumulative View of All No-Transmit Zones

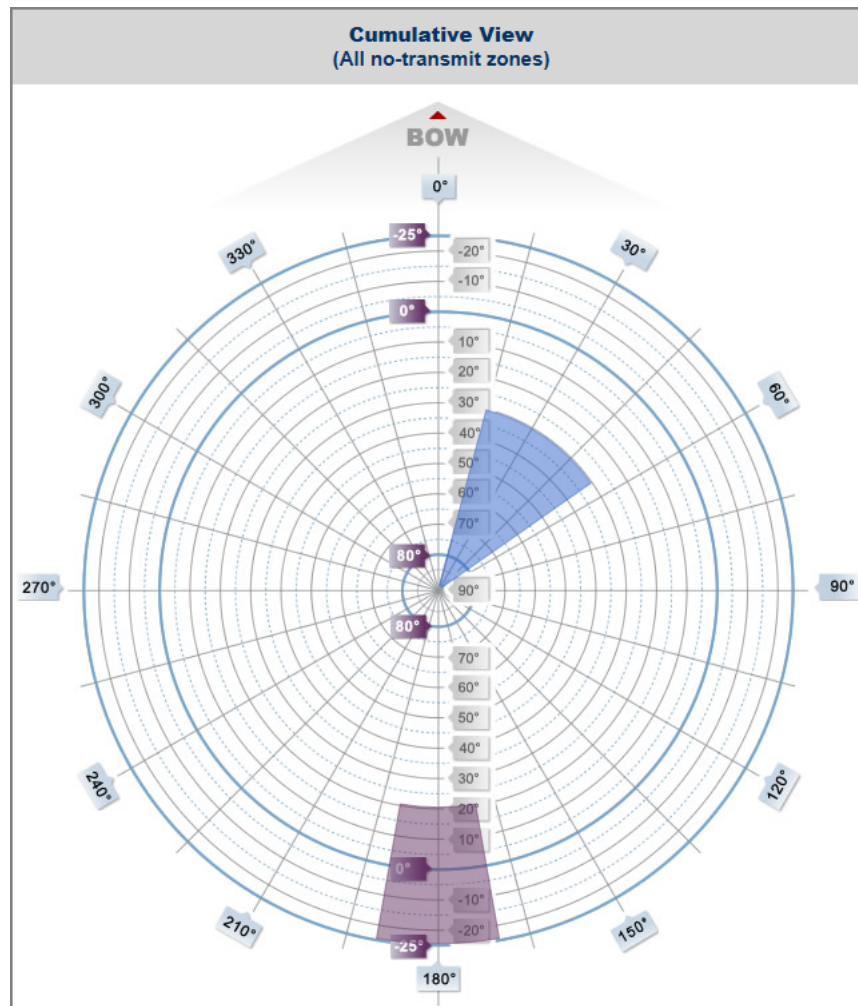

Disabling No-Transmit Zones

You can disable your programmed no-transmit zones to temporarily remove all restrictions on transmissions. This function permits the antenna to ignore the zones; it does not delete them from the system's memory.

CAUTION

Disabling no-transmit zones allows the antenna to transmit in any direction, even if the antenna is pointing in an area accessible to passengers and crew. Make sure everyone stays the minimum safe distance away from the antenna while it is in use (see [“RF Radiation Hazard Area”](#) on page 6).

To disable the no-transmit zones, follow these steps:

1. At the TracPhone V7-HTS web interface, click the **Settings** tab. Then click **No-Transmit Zones**.
2. Click **Edit**.
3. If the Login window appears, log in with the Administrator password.
4. In No-Transmit Zone Ranges, click **Ignore Zones**.
5. Click **Save Settings**.
6. At the confirmation message, click **Ignore Zones**.

Figure 4-7 Disabling No-Transmit Zones

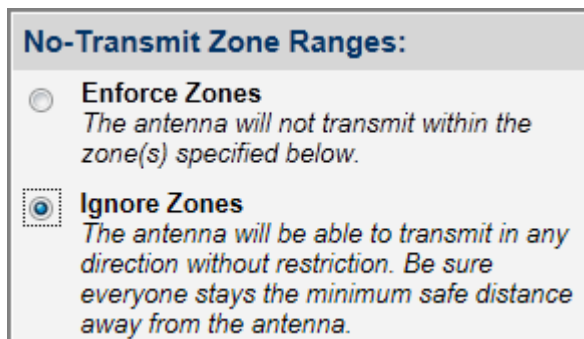

No-Transmit Zone Ranges:

Enforce Zones
The antenna will not transmit within the zone(s) specified below.

Ignore Zones
The antenna will be able to transmit in any direction without restriction. Be sure everyone stays the minimum safe distance away from the antenna.

Clearing No-Transmit Zones

You can clear all no-transmit zones from the system's memory. Unlike disabling zones, clearing zones permanently deletes them.



CAUTION

Clearing no-transmit zones allows the antenna to transmit in any direction without restriction. Make sure everyone stays the minimum safe distance away from the antenna while it is in use (see ["RF Radiation Hazard Area"](#) on page 6).

NOTE: This procedure explains how to clear no-transmit zones using the TracPhone V7-HTS web interface. If you prefer, you may use the front panel LCD menu instead (go to Diagnostic Tools > Factory Reset).

To clear the no-transmit zones, follow these steps:

1. At the TracPhone V7-HTS web interface, click the **Settings** tab. Then click **No-Transmit Zones**.
2. Click **Edit**.
3. If the Login window appears, log in with the Administrator password.
4. In No-Transmit Zone Ranges, click **Clear Zones**.
5. At the confirmation message, click **Clear Zones**.

Figure 4-8 Clearing No-Transmit Zones

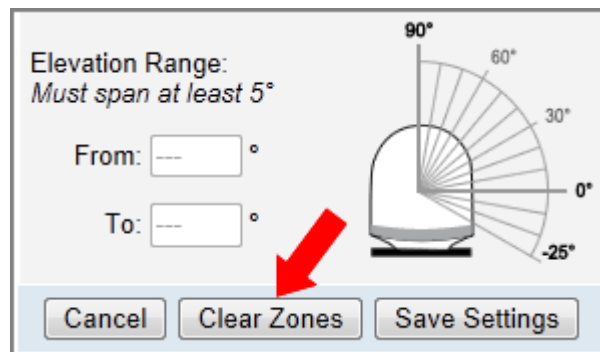



5. Tracking Avoidance Zones

This section explains how to configure, temporarily disable, and clear tracking avoidance zones, which trigger the antenna to switch to another satellite when tracking in a marginal reception area.

Contents

Tracking Avoidance Zones Overview	43
Setting Up Tracking Avoidance Zones	44
Disabling Tracking Avoidance Zones	50
Clearing Tracking Avoidance Zones	51



Tracking Avoidance Zones Overview

In an ideal installation, the antenna has a clear view of the sky in all directions and no other radiating equipment is nearby that can interfere with the satellite signal. However, such an ideal installation is not always achievable on a vessel, particularly on smaller yachts. Therefore, the system allows you to configure up to five tracking avoidance zones for areas where there may be blockage or RF interference causing marginal reception and intermittent antenna performance.

Whenever the antenna is tracking a satellite in the direction of a tracking avoidance zone, it will switch to a different satellite if one is available. An **allowance period** (1-60 minutes, selectable) precludes switching in cases when the antenna is simply passing through a zone while the vessel is turning. The system calculates how long the antenna will be pointing in the zone based on the vessel's rate of turn. If the calculated time exceeds the allowance period, the antenna will immediately switch satellites, as long as there is an alternate satellite available in your service region.

Figure 5-1 Passing Through a Tracking Avoidance Zone (Example)

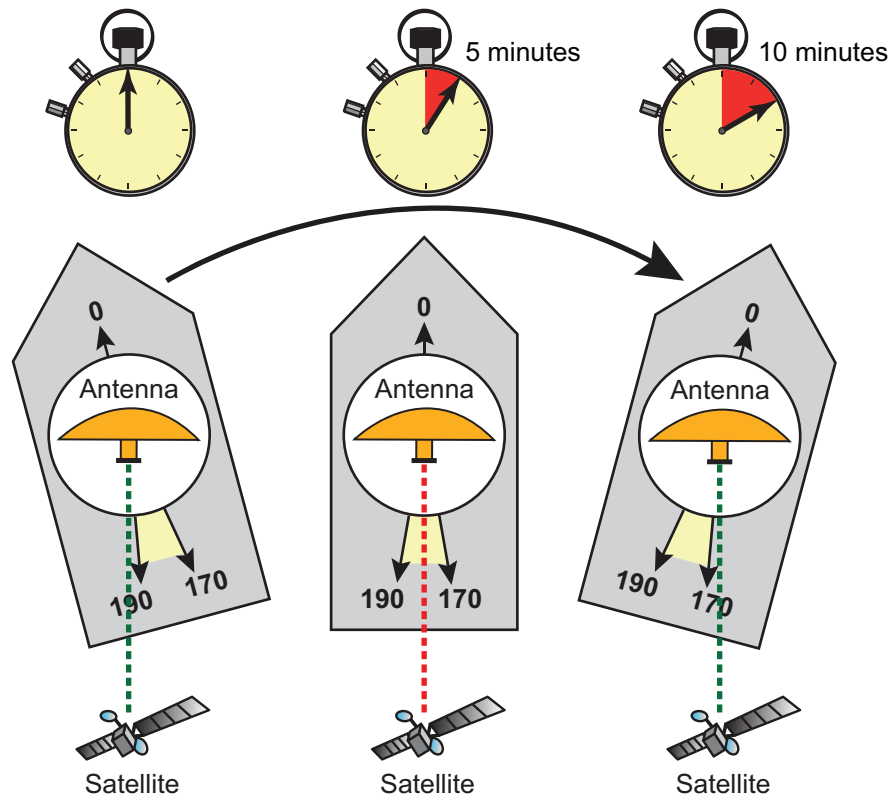

Tracking Avoidance Zone = 170° to 190° (azimuth)
 Rate of Turn = 2° per minute

Setting Up Tracking Avoidance Zones

To manually configure a tracking avoidance zone, follow these steps.

Important!

KVH actively monitors your antenna system's performance and will configure a tracking avoidance zone over the air whenever an obvious blockage area is identified. Therefore, setting up zones yourself on the vessel is unnecessary in most cases.

1. Identify the necessary azimuth range for the zone (see ["Identify the Azimuth Range" on page 45](#)).
2. Identify the necessary elevation range for the zone (see ["Identify the Elevation Range" on page 46](#)).
3. At the TracPhone V7-HTS web interface, configure a tracking avoidance zone for that combination of azimuth and elevation ranges (see ["Configure the Tracking Avoidance Zone\(s\) at the Web Interface" on page 47](#)).

Identify the Azimuth Range

First, you need to determine the necessary azimuth range for the tracking avoidance zone(s). You will need to enter, in clockwise order, the beginning and ending azimuths that define the outer boundaries of the zone, **relative to the antenna's forward arrow**, which should be pointing toward the bow.

NOTE: Each tracking avoidance zone must span at least 5°. Therefore, be sure to set beginning and ending azimuths at least 5° apart.

Figure 5-2 Beginning and Ending Azimuths Defining a Zone (Example)

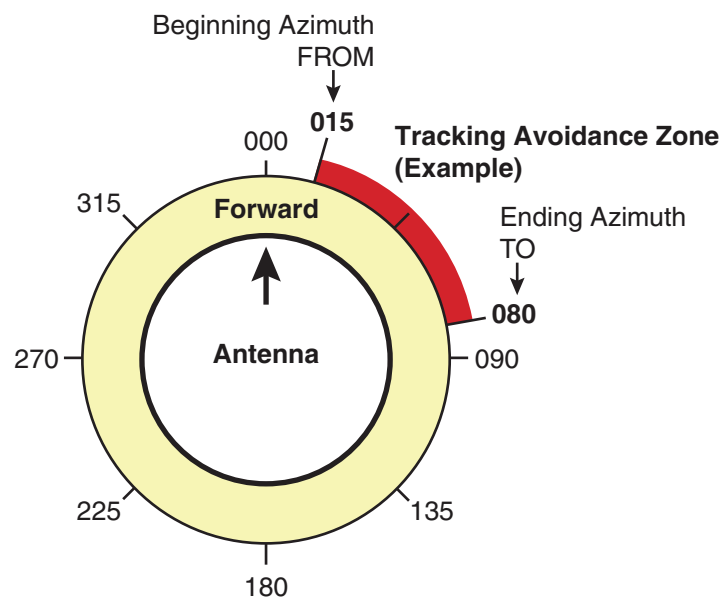

Identify the Elevation Range

Now you need to determine the necessary elevation range for the tracking avoidance zone(s). You will need to enter, in ascending order, the beginning and ending elevations that define the outer boundaries of the zone.

NOTE: Each tracking avoidance zone must span at least 5°. Therefore, be sure to set beginning and ending elevations at least 5° apart.

Figure 5-3 Beginning and Ending Elevations Defining a Zone (Example)

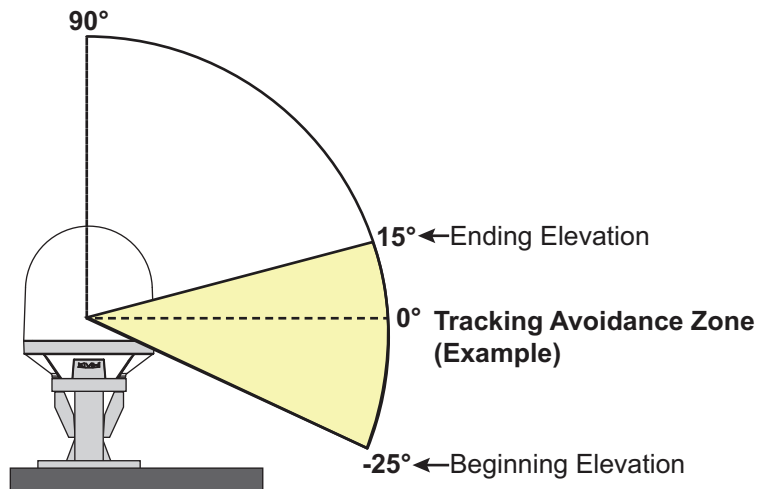



Configure the Tracking Avoidance Zone(s) at the Web Interface

1. At the TracPhone V7-HTS web interface, click the **Settings** tab. Then click **Tracking Avoidance Zones**.
2. Click **Edit**.
3. If the Login window appears, log in with the Administrator password.
4. Enter the azimuth and elevation ranges for Zone 1. Then select the **Enabled** check box.
5. If you wish to set up another tracking avoidance zone, select a zone from the drop-down menu and repeat step 4 for the selected zone.
6. In the Time in Zone box, enter the maximum number of minutes (between 1 and 60) during which the antenna will be allowed to track within a tracking avoidance zone (see [“Tracking Avoidance Zones Overview”](#) on page 43 for details).
7. Click **Save Settings**.
8. At the confirmation message, click **Save**.

Figure 5-4 Configuring Tracking Avoidance Zones

Tracking Avoidance Zone Ranges:

MIN **Time In Zone**
Maximum number of minutes (1-60) the antenna will be allowed to track within the zone(s) specified below

Choose a Zone:

Zone 1

Zone 1 Enabled

Azimuth Range:
Must span at least 5°

From: °
To: °

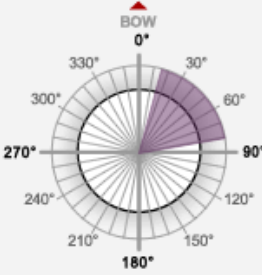

Elevation Range:
Must span at least 5°

From: °
To: °

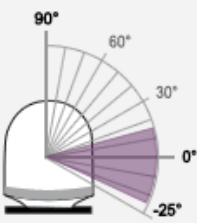

Cancel Clear Zones Save Settings

Understanding the Cumulative View

The Tracking Avoidance Zones page displays a diagram that indicates the cumulative azimuth and elevation ranges of the tracking avoidance zones that are currently enabled. The circumference of the circle indicates azimuth, while the radius indicates elevation. In the example shown here, the following tracking avoidance zones are enabled:

- Zone 1 (purple) = Azimuth: 170° to 190°, Elevation: -25° to 20°
- Zone 2 (blue) = Azimuth: 15° to 55°, Elevation: 30° to 90°

Figure 5-5 Cumulative View of All Enabled Tracking Avoidance Zones

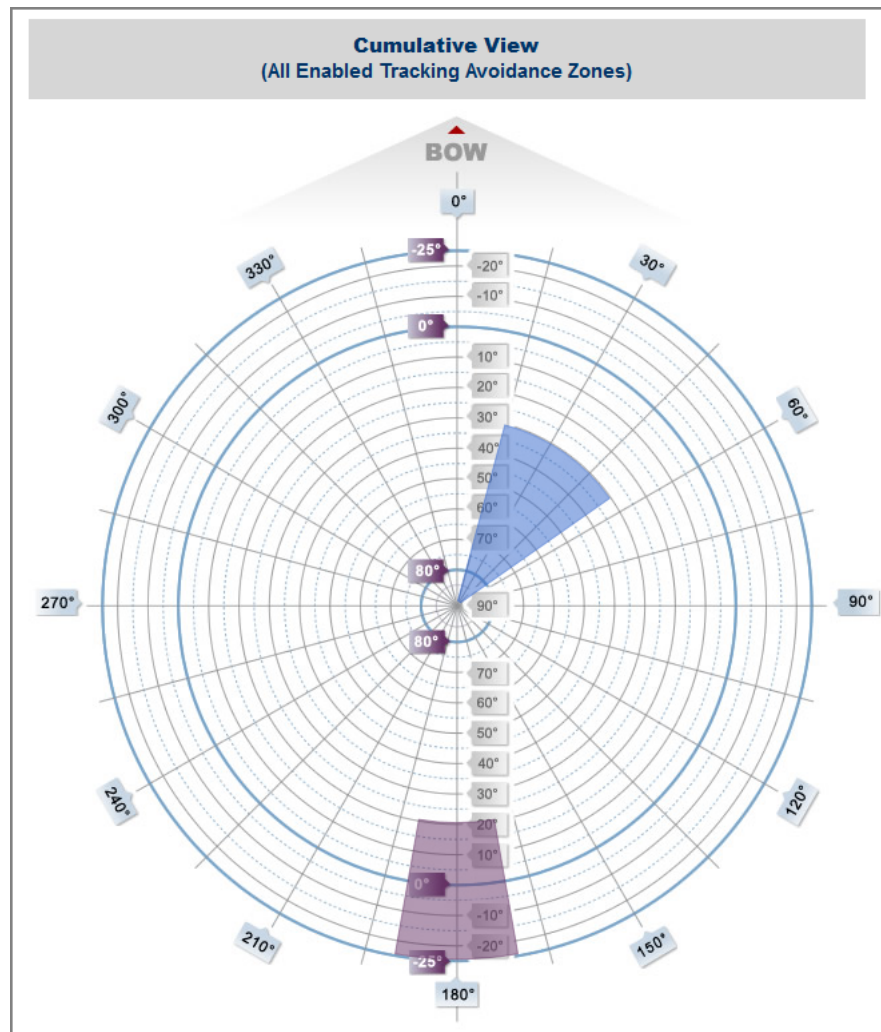

Disabling Tracking Avoidance Zones

You can disable any of your programmed tracking avoidance zones to temporarily remove its restrictions on tracking. This function permits the antenna to ignore the zone(s); it does not delete them from the system's memory.

To disable a tracking avoidance zone, follow these steps:

1. At the TracPhone V7-HTS web interface, click the **Settings** tab. Then click **Tracking Avoidance Zones**.
2. Click **Edit**.
3. If the Login window appears, log in with the Administrator password.
4. Select the zone you want to disable from the drop-down menu.
5. Clear the **Enabled** check box. The zone disappears from the Cumulative View.
6. Click **Save Settings**.
7. At the confirmation message, click **Save**.

Figure 5-6 Disabling Tracking Avoidance Zones

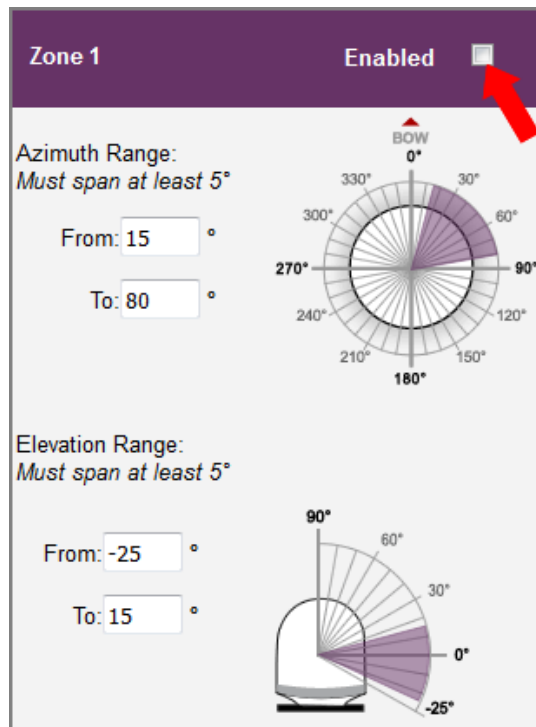

Clearing Tracking Avoidance Zones

You can clear all tracking avoidance zones from the system's memory. Unlike disabling zones, clearing zones permanently deletes them.

To clear the tracking avoidance zones, follow these steps:

1. At the TracPhone V7-HTS web interface, click the **Settings** tab. Then click **Tracking Avoidance Zones**.
2. Click **Edit**.
3. If the Login window appears, log in with the Administrator password.
4. Click **Clear Zones**.
5. At the confirmation message, click **Clear Zones**.

Figure 5-7 Clearing Tracking Avoidance Zones

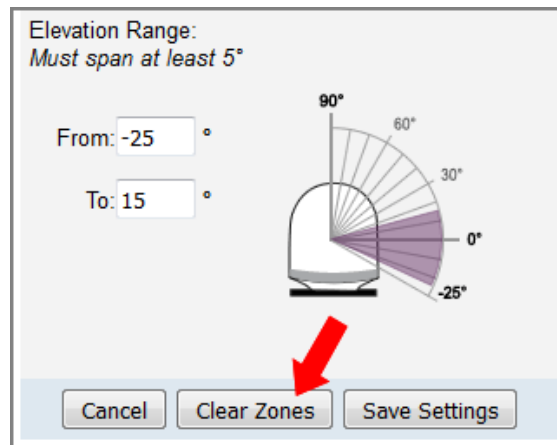



6. Voice Connections

This section covers everything you need to know about the enhanced voice service. It explains how to place calls, add additional phone lines and virtual numbers, check VoiceMail, send a fax, and access your voice account online.

Contents

Voice Service Overview	55
Making a Ship-to-Shore Call	56
Making a Shore-to-Ship Call	58
Adding Phone Lines	59
Virtual Numbers.....	62
VoiceMail	63
Faxing	65
Accessing Your Voice Account	67



Voice Service Overview

KVH's enhanced voice service – Voice over IP (VoIP) optimized for satellite communications – allows you to make and receive phone calls via the TracPhone system and the mini-VSAT Broadband service. Voice traffic is given priority on the network over standard Internet data to ensure the highest quality voice connections at all times.

Important!

The TracPhone V7-HTS voice service will not provide Automatic Number Identification or Automatic Location Information capabilities associated with emergency services, such as 911 or E911. In addition, the voice service will not work in the event of either a network service outage or a power failure. Therefore, it is critical that you maintain your vessel's separate distress and safety communications system for emergency calls. Be sure to inform anyone who may use the TracPhone V7-HTS of the limitations of emergency services. *The manufacturer, distributor, and service provider shall not be liable for, and expressly disclaim, any direct or indirect damages, claims, losses, expenses, liabilities, actions, risks, or harms arising out of or related to the services provided through this equipment, including without limitation, emergency services.*

How the Voice Service Works

When you dial a phone number using the ship's analog phone, the TracPhone system converts its analog signal into digital VoIP data and transmits it over the mini-VSAT Broadband network to an Internet-based SIP (session initiation protocol) server. The digital VoIP data is then converted back into its original analog signal and routed via a proxy server to the appropriate public switched telephone network (PSTN). Finally, the telephone network's carrier completes the call to ring the desired shore phone line.

Figure 6-1 Voice Service Call Routing

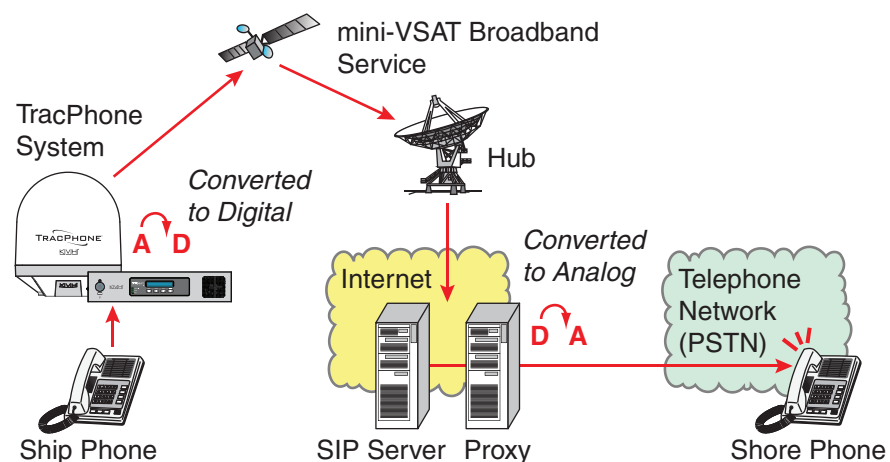

Making a Ship-to-Shore Call

To place a call from the vessel, follow these steps:

1. Make sure the TracPhone system is online.
2. Pick up the handset on any phone connected to the ICM. You should hear a dial tone. If you don't, check the phone line status on the web interface's Home tab.
3. Dial the phone number you wish to call. The dialing sequence you use depends on the vessel's Line 1 phone number.

Dialing a Number Outside the Country Assigned to Line 1

Dial the number as an international call:

<**International prefix**, as originating from your Line 1 country>
+ <**country code**>
+ <**area/city code**>
+ <**local phone number**>

Dialing a Number Within the Country Assigned to Line 1

Dial the number as an in-country call:

<**area/city code**>
+ <**local phone number**>

Dialing a Number Within the Country & Area Code Assigned to Line 1

Dial the number as a local call:

<**local phone number**>

NOTE: When you place a call, your voice travels to a satellite in space then back to Earth. This transit will cause a brief delay (approximately 1/2 second) in your conversation.

Figure 6-2 Ship-to-Shore Calls (Example)

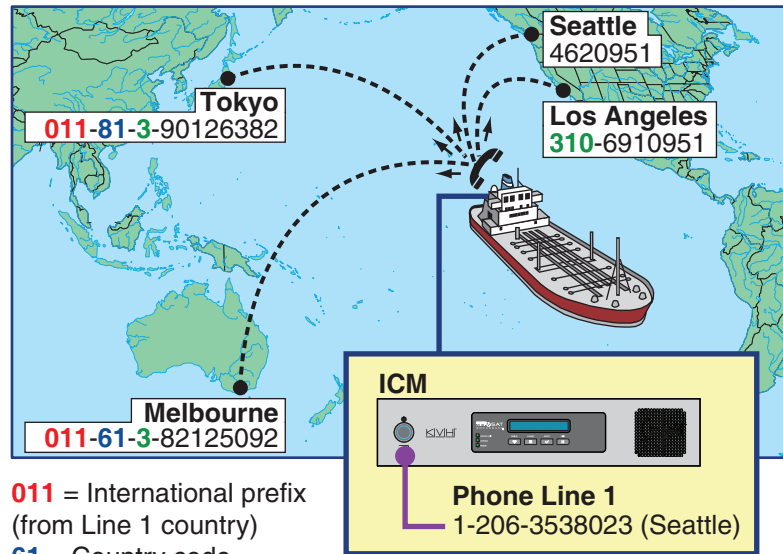

011 = International prefix
(from Line 1 country)
61 = Country code
3 = Area/City code
82125092 = Local phone no.

On an open or fixed rate plan, all calls are charged termination fees as calls originating from the U.S., regardless of vessel location or phone number. Long distance rates will apply. On a metered rate plan, incoming and outgoing calls are charged one flat rate per minute. For details, refer to the rate sheet available online at www.kvh.com/mvbcustomercenter.

Making a Shore-to-Ship Call

People on shore call your vessel by dialing one of your vessel's phone numbers. They are billed international and long-distance charges based on the vessel's phone number, and not on the location of the vessel. Therefore, when you set up phone number(s) during service activation, it is advisable to select the same country code and area/city code you use at home (an additional monthly fee will apply). This will allow family, friends, and business associates in your home region to call your vessel as an in-country call.

NOTE: If you wish to change your vessel's phone number(s), contact KVH's Airtime Services department. See "Contacting the Airtime Services Department" on page 15.

In the example shown here, people in Los Angeles who call the vessel's U.S.-based phone number will not be charged international fees.

Figure 6-3 Shore-to-Ship Calls (Example)

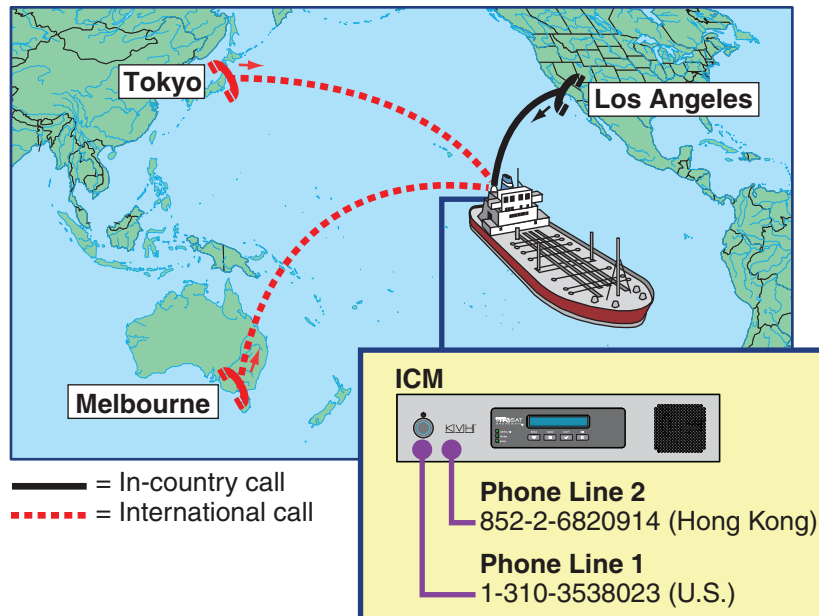

Adding Phone Lines

The ICM supports two phone lines, one for each "Voice Line" jack (an additional monthly fee applies to the optional second line). As a result, the system can support two simultaneous voice calls. However, KVH offers the following optional accessories that add additional phone lines to support three or more simultaneous calls:

- Multimedia Terminal Adapter (MTA) (see ["Additional MTA\(s\)" on page 60](#))
- Crew Calling Gateway (see ["Crew Calling Gateway" on page 61](#))

NOTE: Only voice calls carried on phone lines 1 and 2 are prioritized over general data traffic.

Additional MTA(s)

If your vessel requires more than two phone lines, you may install one or two multimedia terminal adapters (MTAs) (KVH part no. 19-0504) to enable up to four additional lines. This allows the system to sustain three or more simultaneous calls. An additional monthly fee applies to each additional line. In addition, your service plan must accommodate the minimum data rate required (bidirectional) to support these additional lines:

- 1 or 2 phone lines - 128 kbps
- 3 or 4 phone lines - 256 kbps
- 5 or 6 phone lines - 512 kbps

Contact your dealer/distributor for details.

Figure 6-4 Additional MTA Connection

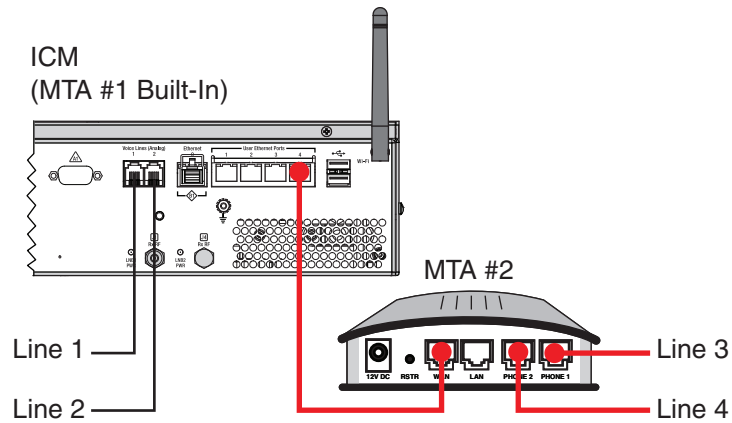

Crew Calling Gateway

The optional Crew Calling Gateway (KVH part no. 72-0349) adds four additional phone lines for crew members and charter passengers to place ship-to-shore calls using prepaid calling cards. Since the ICM also provides two main voice lines, the TracPhone V7-HTS may support up to six simultaneous voice calls with the Crew Calling Gateway installed. To support multiple concurrent calls, your service plan must accommodate the minimum data rate required (bidirectional) to support the total number of calls:

- 1 or 2 concurrent calls - 128 kbps
- 3 or 4 concurrent calls - 256 kbps
- 5 or 6 concurrent calls - 512 kbps

Contact your dealer/distributor for details.

NOTE: As an alternative to the external Crew Calling Gateway, one of the ICM's built-in phone lines can be configured for Crew Calling functionality (KVH part no. 95-0036-1008). Contact KVH Network Services at networkservices@kvh.com for details.

Figure 6-5 Crew Calling Gateway Connections

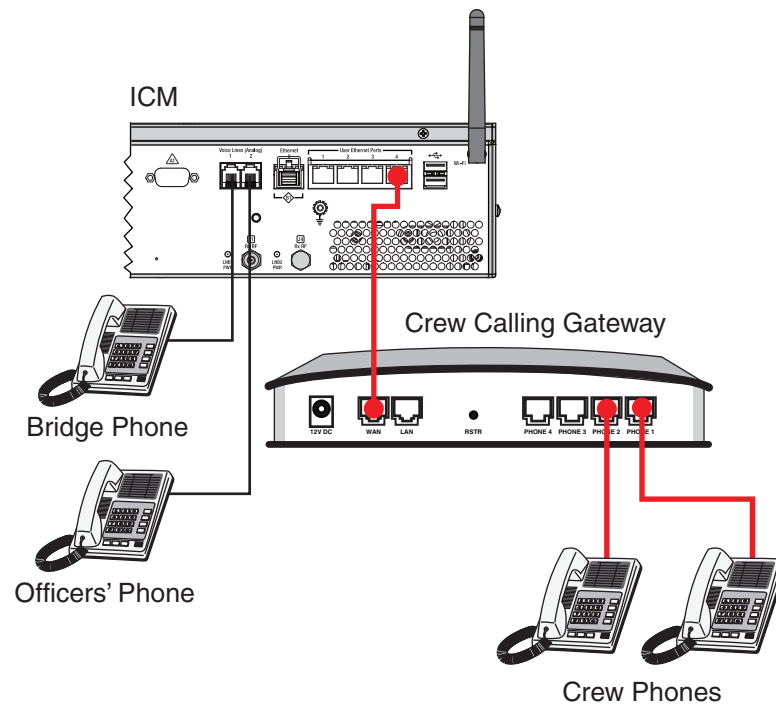

Virtual Numbers

For an additional fee, you may assign up to five virtual phone numbers to each vessel phone line (10 total). Each of these numbers can be set up with a different country code and area/city code, allowing people on shore within those regions to avoid international or long-distance charges when they call the vessel.

To set up virtual numbers, contact KVH's Airtime Services department. See ["Contacting the Airtime Services Department"](#) on page 15.

NOTE: Each virtual number you set up will forward calls to a specific phone line and jack on the ICM (whichever line you requested during setup). Only phones that are connected to that jack will ring when someone dials the virtual number.

In the example shown here, the vessel's company has offices in Tokyo and Melbourne. Therefore, they set up Japanese and Australian virtual numbers so that their employees on shore can call the vessel without running up an international phone bill.

Figure 6-6 Virtual Numbers (Example)

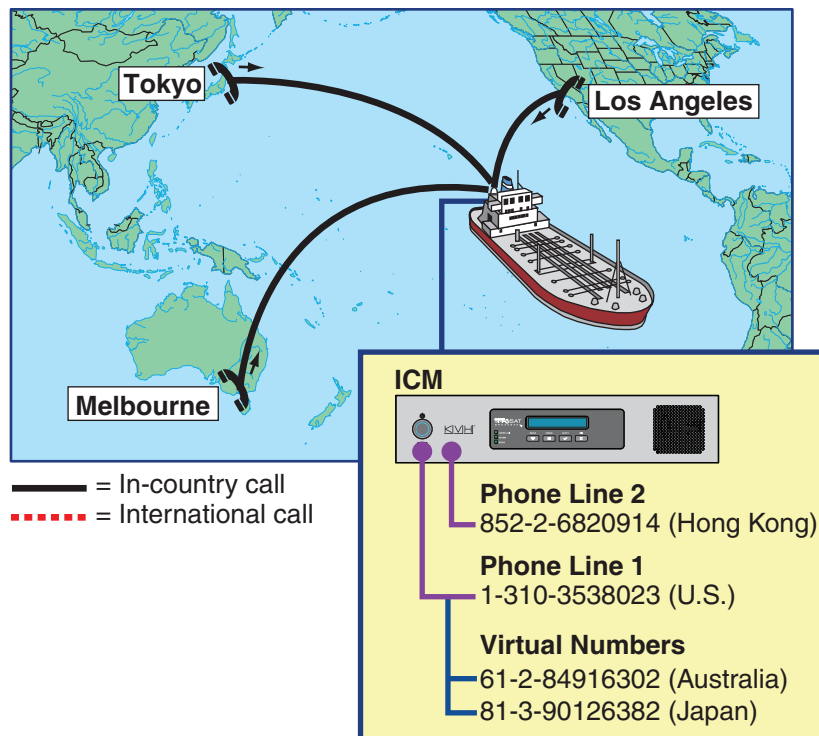

VoiceMail

KVH's enhanced voice service offers a similar suite of features as you might find with any landline telephone service. One of these features is VoiceMail.

With VoiceMail, people who call the vessel may record a message if you are unable to answer the call or the line is busy. You can then play back and listen to your messages anytime (24/7) from anywhere, even if you are not currently onboard the vessel.

Recording a VoiceMail Personal Greeting

To record your VoiceMail personal greeting, follow these steps:

1. Pick up the handset on any phone connected to the ICM. You should hear a dial tone.
2. Dial **123#** to connect to the VoiceMail system.
3. Press **2** to access your mailbox.
4. Press **1** to access your personal greeting.
5. Press **2** to change your greeting. You will be prompted to record your greeting.
6. Press **1** to listen to your personal greeting.
7. When you are satisfied with your greeting, press **3** to accept and activate your greeting. You will hear the message "Your personal greeting has been activated."

Listening to Your VoiceMail Messages

If you hear a fast dial tone pulse in the phone's handset, you have new VoiceMail messages. To listen to your VoiceMail messages, follow these steps:

1. Dial **123#** to connect to the VoiceMail system.
2. Press **1** to listen to your messages.
3. Follow the spoken instructions to listen to, save, and/or delete your messages.

Listening to Your Messages on Shore

You still have access to your VoiceMail messages when you disembark the vessel. Choose one of the following options:

- **Use a computer:** Go to your voice account web page (see ["Accessing Your Voice Account" on page 67](#)). Then click the **VoiceMail** button.
- **Use a regular landline telephone:** Dial the number for your main vessel phone line (Line 1), press *, then enter your PIN (provided during service activation).

Faxing

You can fax documents via the enhanced voice service. Connect a fax machine to either "Voice Line" jack on the ICM and dial the fax number as you would a voice call (see ["Making a Ship-to-Shore Call" on page 56](#)).

NOTE: Faxing requires 70 kbps bandwidth for sending and up to 90 kbps bandwidth for receiving. When fax and voice are used simultaneously, the bandwidth requirement increases to between 100 kbps and 170 kbps.

For extremely reliable faxing, KVH offers the UCH-250 fax server (see ["UCH-250 Fax Server" on page 66](#)). The UCH-250 avoids the industry-wide problem of dropped or incomplete faxes commonly associated with faxing over Voice over IP (VoIP) connections.

UCH-250 Fax Server

Faxing over Internet Protocol can be unreliable at times (normally an 80% success rate). Glitches like latency, packet loss, and jitter, common with any VoIP connection, can interrupt the synchronization necessary for fax communications. KVH's optional UCH-250 Fax Server (KVH part no. 19-0520) overcomes these limitations by providing a dedicated fax line with the reliability of a fully managed, store-and-forward system. In addition to installing the fax server, you will need to activate the supplemental fax service. Contact your dealer/distributor for details.

Figure 6-7 UCH-250 Fax Server Connections

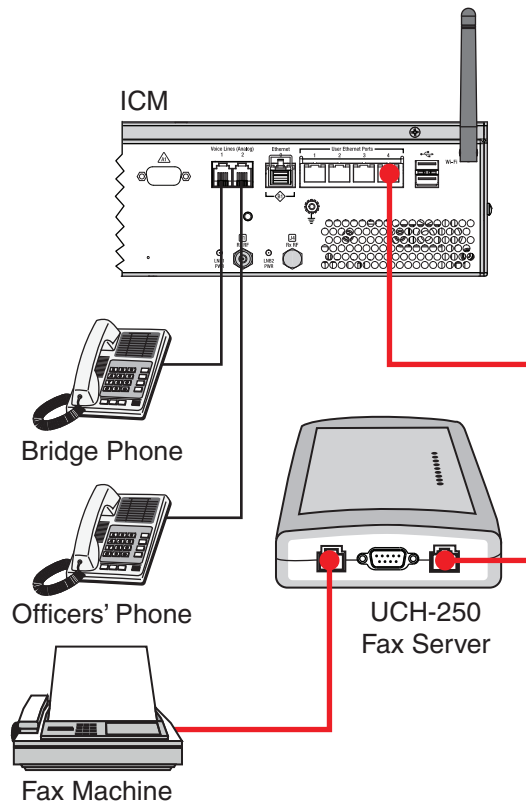

Accessing Your Voice Account

You can manage your account online at KVH's Enhanced VoIP Service Account Center. You can view and configure all of the various calling features available to you, as well as view account information and listen to VoiceMails. To log onto the site, follow these steps:

1. Go to <http://kvh.myaccountcenter.net>.
2. At the login page, enter your Line 1 phone number and PIN, provided during service activation. Then click **Login**.

Figure 6-8 Enhanced VoIP Service Account Center

The screenshot displays the 'mini-VSAT Broadband Enhanced VoIP Service Account Center' interface. At the top right, the logo for 'KVH INDUSTRIES MINI-VSAT BROADBAND' is visible. Below the header, the page title reads 'mini-VSAT Broadband Enhanced VoIP Service' and 'Account Center ::'. A navigation bar includes 'Enhanced VoIP Service Account Center' and a 'Logout' link.

The main content area is titled 'My Information' and is divided into two columns:

- Left Column:**
 - Your Device ID: **00109911fd18**
 - Phone Line(s): [View all phone numbers](#)
 - Line 1 - Phone Number: 14013674517 (dropdown menu)
 - Your calling plan is: **us unlimited (no canada)**
 - You have 0 new VoiceMail messages.
- Right Column (Current Usage):**
 - Current Usage**
 - Period: **14-Jul-2012 to 14-Aug-2012**
 - Calling Plan Usage: Local & National(Unlimited) -- Unlimited

Below the information section, there are four navigation icons: Call History, Find Rates, VoiceMail, and Manage Features. A section titled 'Test your Internet connection speed:' provides instructions on using a speed test at www.voipreview.org. A final note says 'Finished with Enhanced VoIP Service Account Center: Please Logout.'

The footer contains navigation links for www.kvh.com, 'Your Account Home', and 'Technical Support'. A promotional banner at the bottom reads: 'You've chosen TracPhone for marine satellite communications, now choose TracVision for your onboard entertainment needs. :: Visit www.tracvision.com today.' The banner also features images of TracVision satellite devices.

7. Network Configuration

This section explains the various network configuration options for connecting your vessel's computers and other network devices to the TracPhone system. It also provides an overview of the advanced network settings that are available.

Contents

Selecting a Network Configuration.....	71
Standard HTS Configuration	74
Static IP HTS Configuration	77
Open Access HTS Configuration	81
Compatible Configurations for Media Server.....	82
Configuring Computers for DHCP	85
LAN Settings.....	91
Cache Settings	92
Setting Up Data Usage Alerts	93
CommBox Settings	94
Reset to Factory Configuration	95

Selecting a Network Configuration

The ICM includes four Ethernet ports and a built-in wireless access point (WAP) that can be configured in a variety of ways to meet your vessel's needs.

Figure 7-1 Ethernet Ports and Wireless Access Point

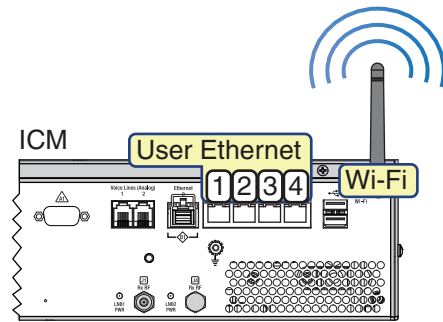

Some of the most common configurations can be set up directly from the TracPhone V7-HTS web interface or the mini-VSAT Manager:

Option	Description
Standard HTS	Port 1: Unlimited LAN Ports 2-4, Wi-Fi: High-speed LAN with access control
Static IP HTS	Port 1: Unlimited LAN Ports 2-3, Wi-Fi: High-speed LAN with access control Port 4: Accessory LAN (reserved for optional service such as Global Static IP, KVH Media Server, external MTA, or Crew Calling)
Open Access HTS	Port 1: Unlimited LAN Ports 2-3, Wi-Fi: High-speed LAN with unrestricted access Port 4: Accessory LAN (reserved for optional service such as Global Static IP, KVH Media Server, external MTA, or Crew Calling)

If your vessel requires a custom configuration, please contact KVH Network Services at networkservices@kvh.com.

Important!

The TracPhone V7-HTS system provides two separate data paths for Internet access:

- **High-speed LAN** – Fastest speeds: uses open airtime plan that includes an allotment of data usage; overage charges apply
- **Unlimited LAN** – Minimal speeds; uses fixed-rate airtime plan

It is important to understand these differences before you select your ICM network configuration. Also keep in mind that these are separate networks that must not be connected to each other.

To select an ICM network configuration, follow these steps:

1. At the TracPhone V7-HTS web interface, click the **Settings** tab. Then click **Network Settings**.

NOTE: You can also change the ICM's network configuration at the mini-VSAT Manager (www.mykvh.com). Go to the ICM > Network Configuration section of the Vessel Details page and select Configure Network.

2. In Network Configuration, click **Edit**.

3. Select an option from the Configuration drop-down menu.
Then click **Save**.

Figure 7-2 Selecting a Network Configuration

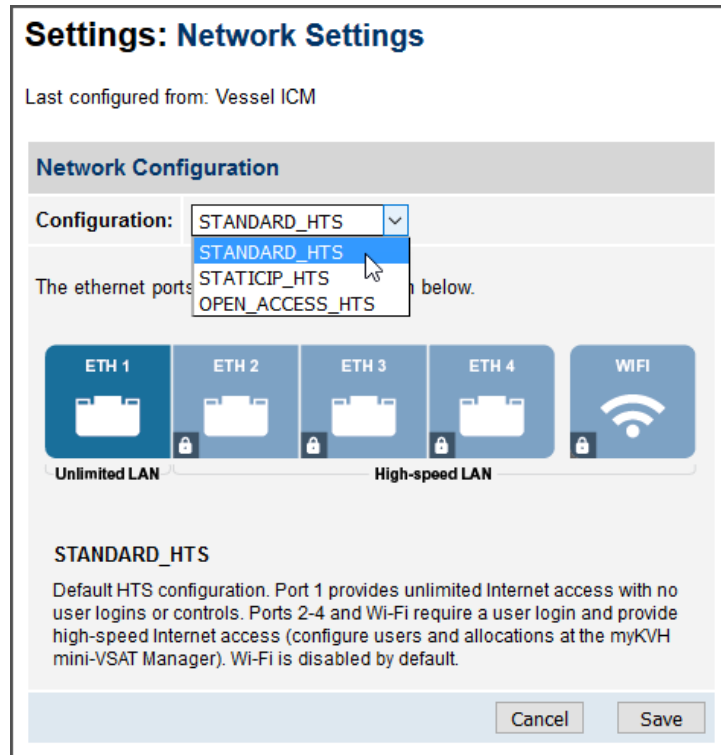

4. At the confirmation message, click **Save**.
5. Follow the additional steps for your chosen configuration:
 - “Standard HTS Configuration” on page 74
 - “Static IP HTS Configuration” on page 77
 - “Open Access HTS Configuration” on page 81

NOTE: Whenever you change the ICM's network configuration, its built-in wireless access point (WAP) reverts to Off, its default setting.

Standard HTS Configuration

In a Standard HTS configuration, Ethernet port 1 provides unlimited Internet access with no user logins or controls. Ports 2 through 4 and the built-in WAP require a user login and provide high-speed access. This is the default configuration.

Figure 7-3 Standard HTS Configuration

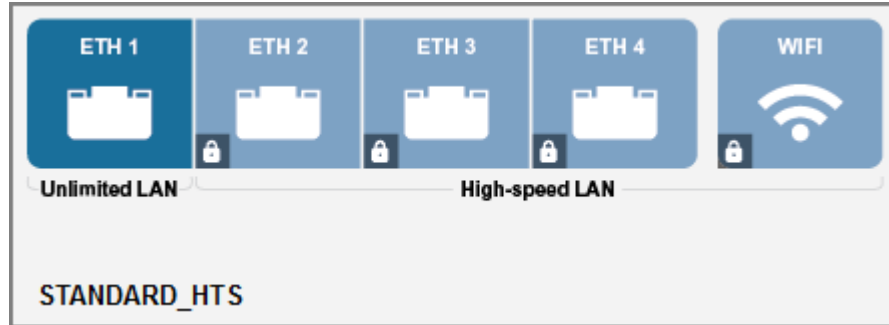

To set up the network in a standard HTS configuration, follow these steps:

1. To enable the ICM's built-in wireless access point (WAP) for Wi-Fi access, follow the steps in ["Wireless Settings" on page 83](#).
2. Connect your computers and/or other network devices to the ICM. Make sure you connect to the port(s) that correspond to the desired Internet connection path(s): Unlimited or High-speed. For example, you might wish to add an external WAP (or Wi-Fi router configured for bridge mode) to supplement Wi-Fi access. *Use straight-through 100 Mbps fast Ethernet UTP CAT5 cables (or better) with RJ45 connectors.*

Figure 7-4 Standard HTS Configuration Wiring Example

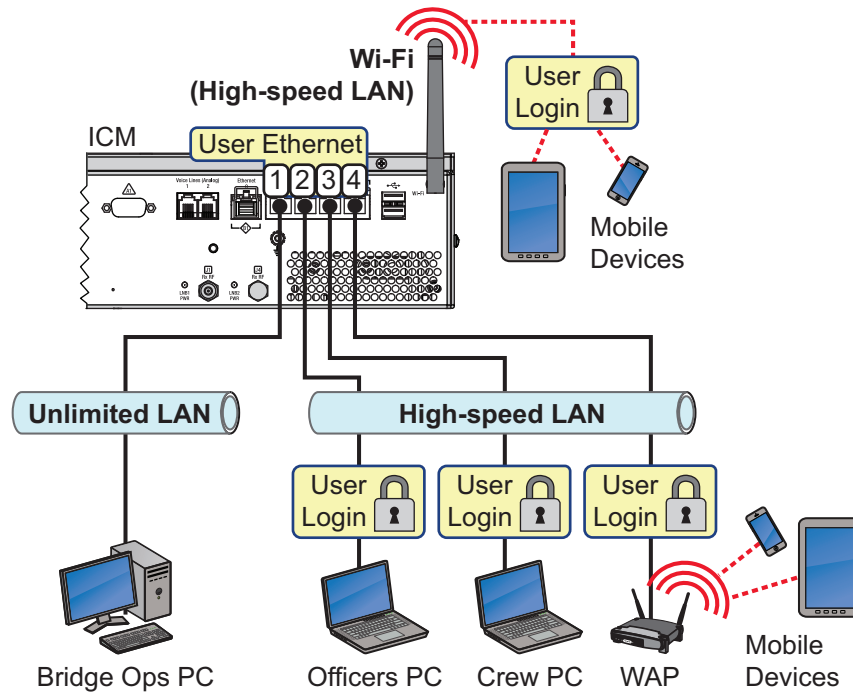

3. Make sure all computers are configured for DHCP addressing (see [“Configuring Computers for DHCP”](#) on page 85). Devices connected to the ICM (via Ethernet cables or Wi-Fi) will receive IP addresses from the ICM via DHCP. The ICM serves as a router.
4. Set up user names and passwords and allocate data for each High-speed LAN user at the mini-VSAT Manager (www.mykvh.com). Go to the Terminal > Data Plan section of the Vessel Details page and select Data Allocation.

Figure 7-5 Data Allocation: Users (Example)

Data Allocation			
KVH Satisfaction			
KVH Demo			
Add User		Send Changes to Vessel	
		■ - changes have not been sent to vessel ■ - awaiting confirmation from vessel	
Users		Allocation Profiles	
User Name ▲	First Name	Last Name	Allocation Profile
Isvensen	Lars	Svensen	Crew
jdoe	John	Doe	Crew

Figure 7-6 Data Allocation: Allocation Profiles (Example)

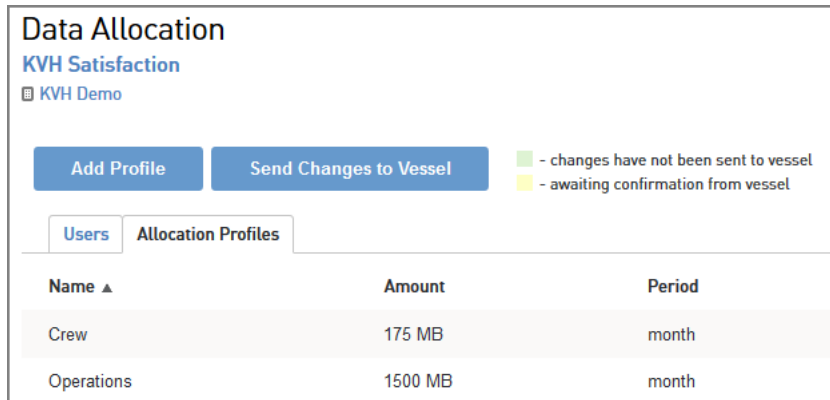

The screenshot displays the 'Data Allocation' section for 'KVH Satisfaction' under 'KVH Demo'. It features two buttons: 'Add Profile' and 'Send Changes to Vessel'. A legend indicates that green text means 'changes have not been sent to vessel' and yellow text means 'awaiting confirmation from vessel'. Below the buttons are two tabs: 'Users' and 'Allocation Profiles'. The 'Allocation Profiles' tab is active, showing a table with three columns: 'Name', 'Amount', and 'Period'. The table lists two profiles: 'Crew' with 175 MB for a month, and 'Operations' with 1500 MB for a month.

Name ▲	Amount	Period
Crew	175 MB	month
Operations	1500 MB	month

NOTE: By default, the High-speed LAN has a gateway of 192.168.6.1 and assigns IP addresses in the 192.168.6.50-150 range. If this configuration conflicts with an existing onboard network, you may change the settings at the TracPhone V7-HTS web interface (go to Settings > Network Settings). See “LAN Settings” on page 91 for details. The Unlimited LAN (gateway 192.168.5.1) cannot be changed at the web interface. If it conflicts with an existing network, please contact KVH Technical Support for assistance.

Static IP HTS Configuration

In a Static IP HTS configuration, Ethernet port 1 provides unlimited Internet access with no user logins or controls. Ports 2 and 3 and the built-in WAP require a user login and provide high-speed Internet access. Port 4 is reserved for an optional KVH service, such as Global Static IP.

Important!

You should only assign a static IP address to a secure device, such as a firewall router.

A static IP connection is commonly used by commercial vessels to enable remote monitoring and IT management from shore, and to allow a vessel's crew to access their company's secure VPN (virtual private network).

Figure 7-7 Common Static IP Applications

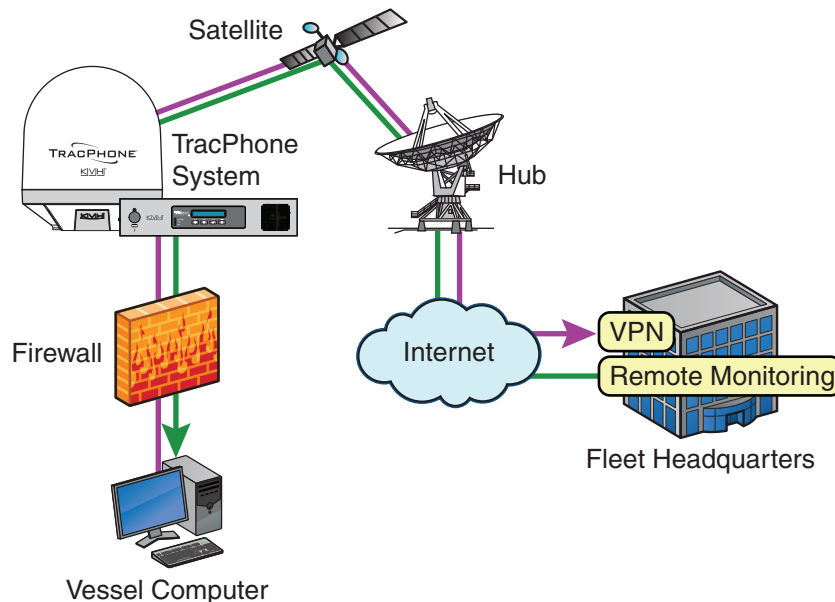

To set up the network in a static IP configuration, follow these steps:

1. Make sure the system is activated for mini-VSAT Broadband service.
2. Turn on the TracPhone system and make sure it is "Online." The system must remain online to allow KVH to set up your system over the satellite link.

3. Fill out the online form at www.kvh.com/staticip. Be sure to read all of the details on this form. An additional monthly fee for static IP service will apply.

Important!

Only the "User Ethernet 4" port on the ICM can be used to connect static IP devices, as this port bypasses the ICM's local subnet to connect directly to the built-in modem.

4. Connect your network device or computer to the "User Ethernet 4" port on the rear panel of the ICM. Use a straight-through CAT5 (or better) Ethernet cable with RJ45 connectors.

Figure 7-8 Static IP HTS Configuration Wiring Example

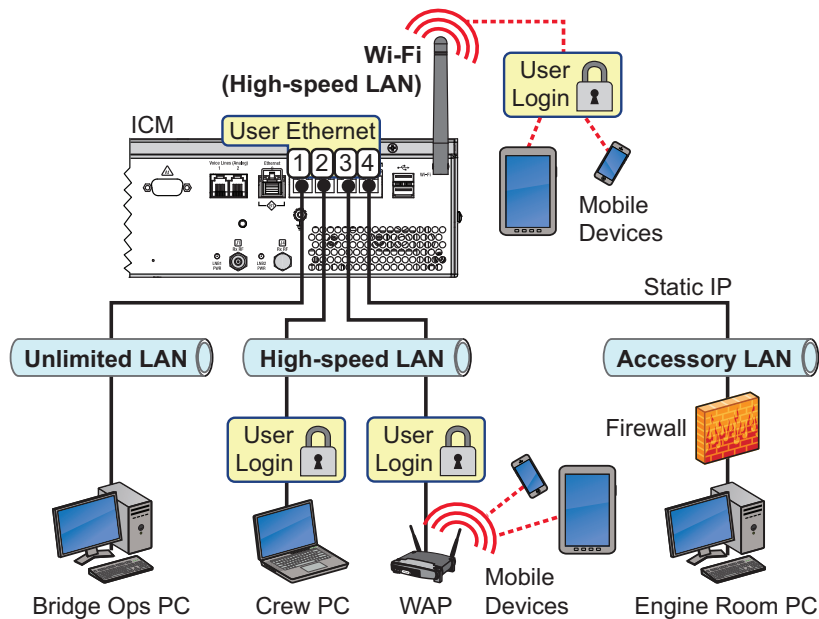

5. At the TracPhone V7-HTS web interface or mini-VSAT Manager, select the **Static IP HTS** network configuration. Refer to "Selecting a Network Configuration" on page 71 for details.

Figure 7-9 Static IP HTS Configuration

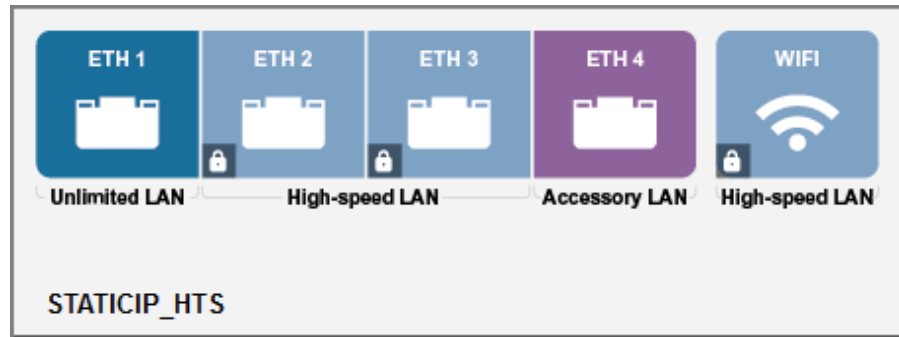

- When you receive an email from KVH confirming that your static IP address has been set up, configure the TCP/IP properties of your network device or computer with the static IP data provided in the email. For details on accessing your computer's TCP/IP properties, refer to [“Configuring Computers for DHCP”](#) on page 85.

Figure 7-10 Static IP HTS Data

From: KVH
 To: Vessel Owner

IP address:
 Private static IP address

Subnet mask:
 Private static IP subnet mask

Default gateway & Preferred DNS server:
 Private static IP gateway

IP address to access the vessel's computer remotely from shore ← Public static IP address

- Connect all other (non-static IP) computers and/or network devices to “User Ethernet” ports 1-3 on the rear panel of the ICM. Make sure you connect to the port(s) that correspond to the desired Internet connection path(s): Unlimited or High-speed. For example, you might wish to add an external WAP (or Wi-Fi router configured for bridge mode) to supplement Wi-Fi access. *Use straight-through 100 Mbps fast Ethernet UTP CAT5 cables (or better) with RJ45 connectors.*

8. To enable the ICM's built-in wireless access point (WAP) for Wi-Fi access, follow the steps in ["Wireless Settings" on page 83](#).
9. Make sure all non-static IP computers are configured for DHCP addressing (see ["Configuring Computers for DHCP" on page 85](#)). Devices connected to "User Ethernet" ports 1-3 and Wi-Fi will receive IP addresses from the ICM via DHCP. The ICM serves as a router.
10. Set up user names and passwords and allocate data for each High-speed LAN user at the mini-VSAT Manager (www.mykvh.com). Go to the Terminal > Data Plan section of the Vessel Details page and select Data Allocation.

Figure 7-11 Data Allocation: Users (Example)

User Name ▲	First Name	Last Name	Allocation Profile
Isvensen	Lars	Svensen	Crew
jdoe	John	Doe	Crew

Figure 7-12 Data Allocation: Allocation Profiles (Example)

Name ▲	Amount	Period
Crew	175 MB	month
Operations	1500 MB	month

NOTE: By default, the High-speed LAN has a gateway of 192.168.6.1 and assigns IP addresses in the 192.168.6.50-150 range. If this configuration conflicts with an existing onboard network, you may change the settings at the TracPhone V7-HTS web interface (go to Settings > Network Settings). See ["LAN Settings" on page 91](#) for details. The Unlimited LAN (gateway 192.168.5.1) cannot be changed at the web interface. If it conflicts with an existing network, please contact KVH Technical Support for assistance.

Open Access HTS Configuration

In an Open Access HTS configuration, Ethernet port 1 provides unlimited Internet access, and Ports 2 and 3 and the built-in WAP provide high-speed Internet access, with no user logins or controls. Port 4 is reserved for an optional KVH service such as Global Static IP. Port 4 is reserved for an optional KVH service such as Global Static IP.

This configuration is identical to the Static IP HTS configuration, but without access control.

Figure 7-13 Open Access HTS Configuration

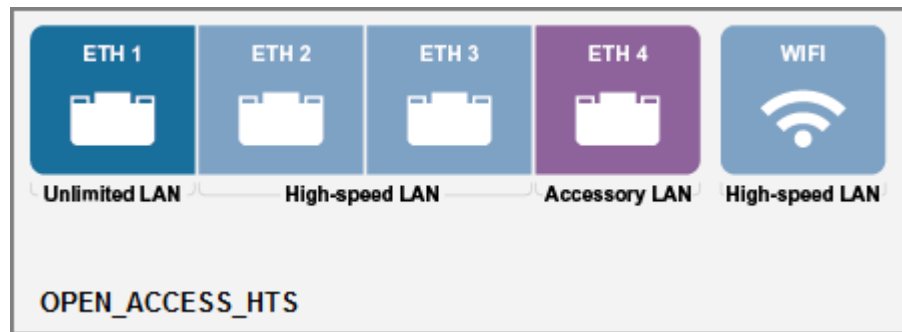
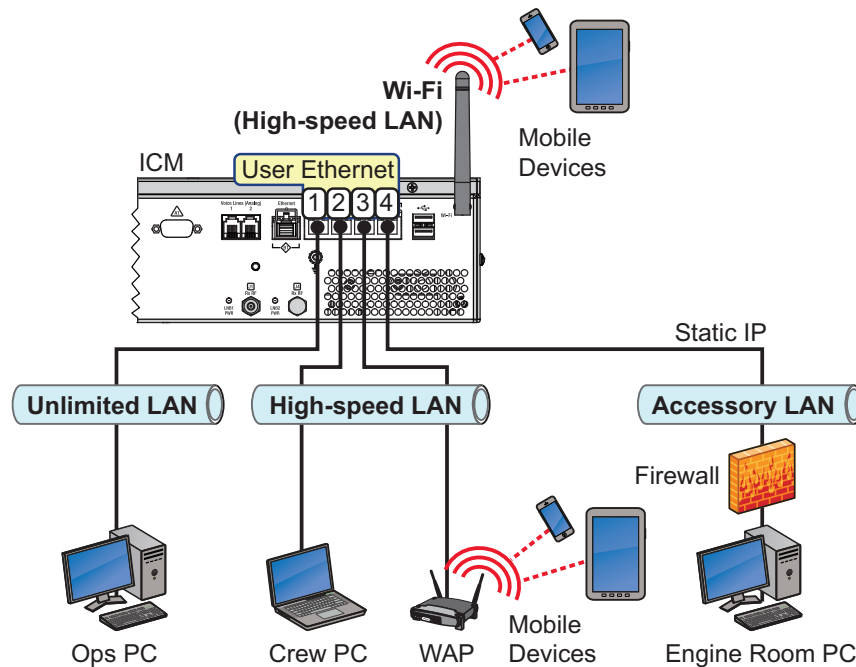

Figure 7-14 Open Access HTS Configuration Wiring Example



For details on setting up the Unlimited LAN and High-speed LAN, refer to [“Standard HTS Configuration”](#) on page 74, except disregard setting up user names/passwords and data allocations.

For details on setting up a Static IP address, refer to [“Static IP HTS Configuration”](#) on page 77.

Compatible Configurations for Media Server

If you connect a KVH Media Server to the TracPhone system for KVH Link content delivery via the IP-MobileCast service, you need to set the ICM to one of the following network configurations:

- Static IP HTS
- Open Access HTS

The Media Server requires a connection to the ICM's Accessory LAN (port 4), in addition to a vessel network (Unlimited LAN, High-speed LAN, or a separate IP-MobileCast LAN). Refer to the Media Server Installation Guide for complete details about installing and configuring the Media Server.

Wireless Settings

With Wi-Fi enabled, vessel devices can connect to the ICM via its built-in wireless access point (WAP) and receive IP addresses from the ICM via DHCP.

Important!

The range of the ICM's WAP will depend on the layout and structure of the vessel. For example, wireless signals degrade when passing through bulkheads and near metal masses. If the system is installed on a steel vessel, you might need a special WAP and the services of a technician with advanced networking expertise.

Figure 7-15 Wireless DHCP (Example)

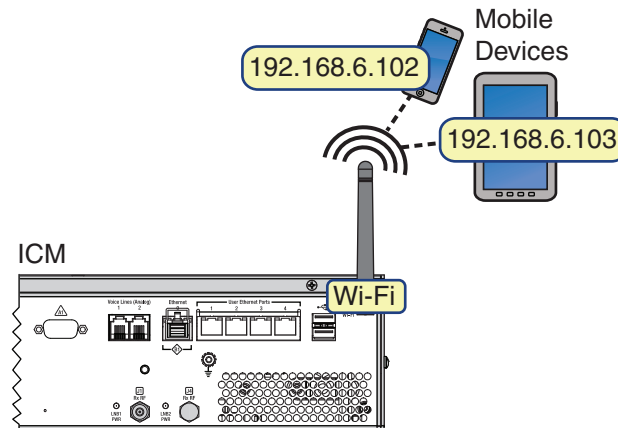

NOTE: If the optional CommBox software is enabled, the Network Settings page of the ICM/mini-VSAT Manager will not contain any configurable fields.

To enable and configure the ICM's Wi-Fi connection, follow these steps:

1. At the TracPhone V7-HTS web interface, click the **Settings** tab. Then click **Network Settings**.

NOTE: You can also change the ICM's Wi-Fi settings at the mini-VSAT Manager (www.mykroh.com). Go to the ICM > Network Configuration section of the Vessel Details page and select Wi-Fi Settings.

2. In Wireless Settings, click **Edit**.
3. If the Login window appears, log in with the Administrator password.

4. Set the following wireless options:

State: Select On.

SSID: Enter a unique name for the vessel network.

Protocol: Select either 802.11b or 802.11g.

Security: Select either security type – WPA2 or WEP (128-bit).

Password/Passphrase: If you selected WPA2, enter a password (between 8-20 characters). If you selected WEP, enter a passphrase (must be 13 characters).

Channel: Keep the default, or select any channel for wireless communications.

Important!

Failure to apply security settings will make your vessel's wireless network vulnerable to outside intrusion.

Figure 7-16 Wireless Settings

Wi-Fi Settings	
State:	<input checked="" type="radio"/> On <input type="radio"/> Off (default)
SSID:	<input type="text" value="MyVesselNetwork"/> (Up to 32 characters)
IP Address:	<input type="text" value="192 . 168 . 6 . 1"/>
Protocol:	<input type="text" value="802.11b"/>
Security:	<input type="text" value="WPA2"/>
Password:	<input type="text" value="••••••••"/> (between 8 to 20 characters)
Channel:	<input type="text" value="7"/>
<input type="button" value="Cancel"/> <input type="button" value="Save"/>	

5. Click **Save**.
6. At the confirmation message, click **Save**.
7. Make sure your computers are equipped with a wireless network interface card and configured for DHCP addressing (see [“Configuring Computers for DHCP”](#) on page 85).

Configuring Computers for DHCP

To configure your computers for DHCP, allowing them to receive IP addresses from the ICM, follow the steps for your operating system:

- [“Windows 10 DHCP Settings”](#)
- [“Windows 8 DHCP Settings” on page 86](#)
- [“Windows 7 or Windows Vista DHCP Settings” on page 87](#)
- [“Windows XP DHCP Settings” on page 88](#)
- [“Mac OS X DHCP Settings” on page 90](#)

Windows 10 DHCP Settings

To configure a Windows 10 computer for DHCP addressing, follow these steps:

1. Open the **Network and Sharing Center**. The easiest way to get there is to simply type the name in the search box on the taskbar. You can also navigate to it from the Start menu: Settings > Network & Internet > Ethernet > Network and Sharing Center.
2. In Network and Sharing Center, click the **Ethernet** link for the Ethernet connection you are using for mini-VSAT Broadband.
3. In the Ethernet Status dialog box, click **Properties**. *If this screen doesn't appear, just skip to Step 4.*
4. In the Ethernet Properties dialog box, on the **Networking** tab, select **Internet Protocol Version 4**, and then click **Properties**.
5. In the Internet Protocol Properties dialog box, select **Obtain an IP address automatically** and **Obtain DNS server address automatically**. Then click **OK**.

Figure 7-17 Windows 10- Internet Protocol Properties

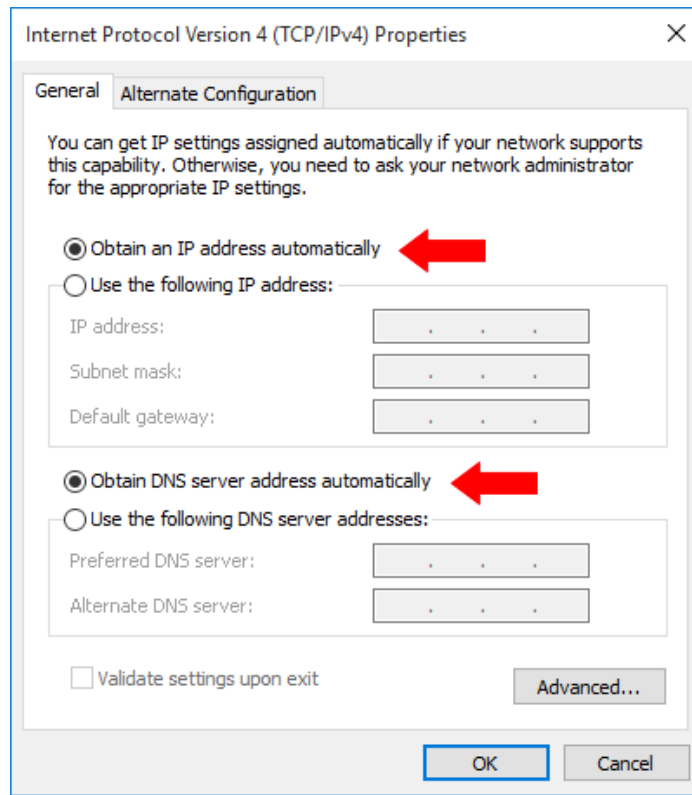

6. In the Ethernet Properties dialog box, click **Close**.

Windows 8 DHCP Settings

To configure a Windows 8 computer for DHCP addressing, follow these steps:

1. In Control Panel, double-click **Network and Sharing Center**.
To open the Control Panel, go to the desktop, select Settings from the Charms bar, then select Control Panel.
2. In Network and Sharing Center, double-click the **Ethernet** link for the Ethernet connection you are using for mini-VSAT Broadband.
3. In the Ethernet Status dialog box, click **Properties**. *If this screen doesn't appear, just skip to Step 4.*
4. In the Ethernet Properties dialog box, on the **Networking** tab, select **Internet Protocol Version 4**, and then click **Properties**.

5. In the Internet Protocol Properties dialog box, select **Obtain an IP address automatically** and **Obtain DNS server address automatically**. Then click **OK**.

Figure 7-18 Windows 8 - Internet Protocol Properties

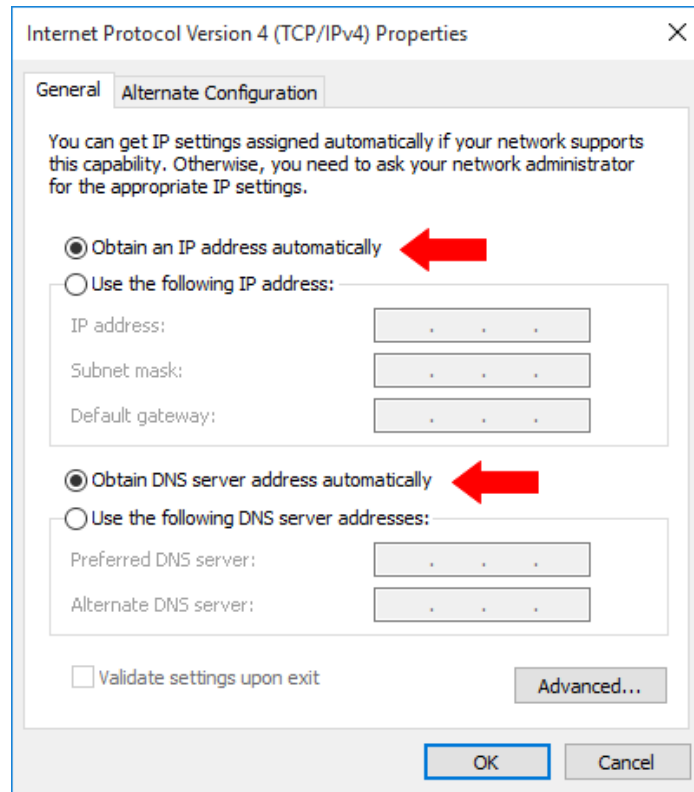

6. In the Ethernet Properties dialog box, click **Close**. Then click **Close** in the Ethernet Status dialog box.

Windows 7 or Windows Vista DHCP Settings

To configure a Windows 7 or Windows Vista computer for DHCP addressing, follow these steps:

1. In Control Panel, double-click **Network and Sharing Center**. (You might need to click **Network and Internet** first.) *You can find the Control Panel either through the Start menu or "My Computer."*
2. In Network and Sharing Center, double-click the **Local Area Connection** (Windows 7) or **View Status** (Windows Vista) for the Ethernet connection you are using for mini-VSAT Broadband.
3. In the Local Area Connection Status dialog box, click **Properties**. *If this screen doesn't appear, just skip to Step 4.*

4. In the Local Area Connection Properties dialog box, click the **Networking** tab, select **Internet Protocol Version 4**, and then click **Properties**.
5. In the Internet Protocol Properties dialog box, select **Obtain an IP address automatically** and **Obtain DNS server address automatically**. Then click **OK**.

Figure 7-19 Windows 7/Windows Vista - Internet Protocol Properties

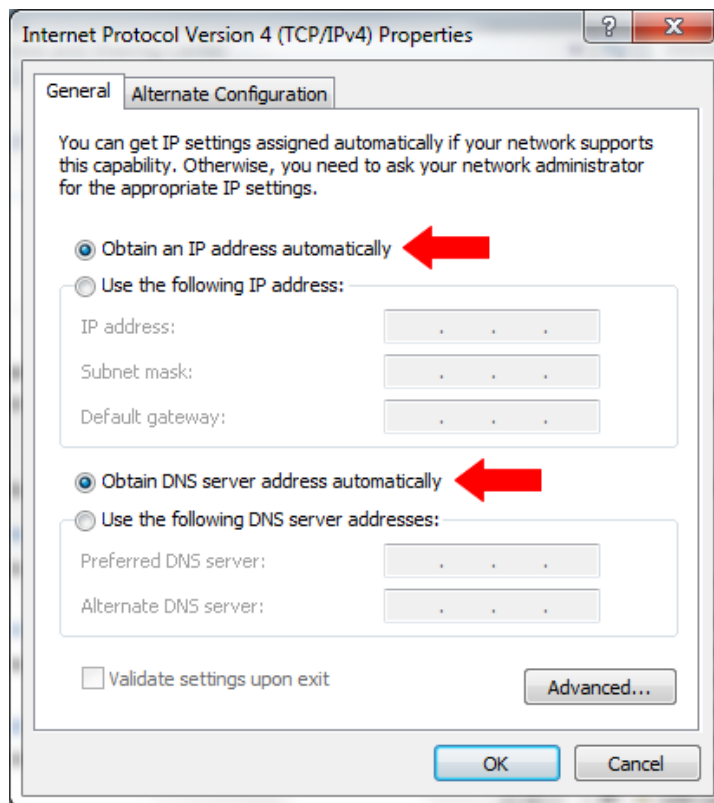

6. In the Local Area Connection Properties dialog box, click **OK**.

Windows XP DHCP Settings

To configure a Windows XP computer for DHCP addressing, follow these steps:

1. In Control Panel, double-click **Network Connections**. *You can find the Control Panel either through the Start menu or "My Computer."*
2. In Network Connections, double-click the **Local Area Connection** for the Ethernet connection you are using for mini-VSAT Broadband.

3. In the Local Area Connection Status dialog box, click the **General** tab. Then click **Properties**. *If this screen doesn't appear, simply skip to Step 4.*
4. In the Local Area Connection Properties dialog box, click the **General** tab, select **Internet Protocol (TCP/IP)**, and then click **Properties**.
5. In the Internet Protocol (TCP/IP) Properties dialog box, click the **General** tab. Then select **Obtain an IP address automatically** and **Obtain DNS server address automatically**. Then click **OK**.

Figure 7-20 Windows XP - Internet Protocol (TCP/IP) Properties

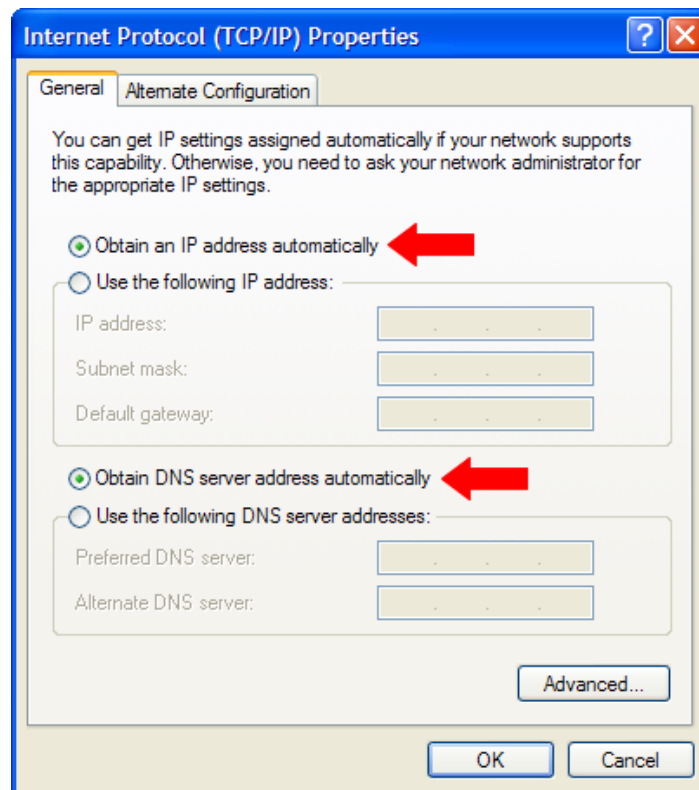

6. In the Local Area Connection Properties dialog box, click **OK**.
7. Restart your computer.

Mac OS X DHCP Settings

To configure a Mac OS X computer for DHCP addressing, follow these steps:

1. In System Preferences, click **Network**.
2. In the Network dialog box, select **Ethernet** then set the following:
 - Location: **Automatic**
 - Configure IPv4: **Using DHCP**

Figure 7-21 Mac OS X - Network

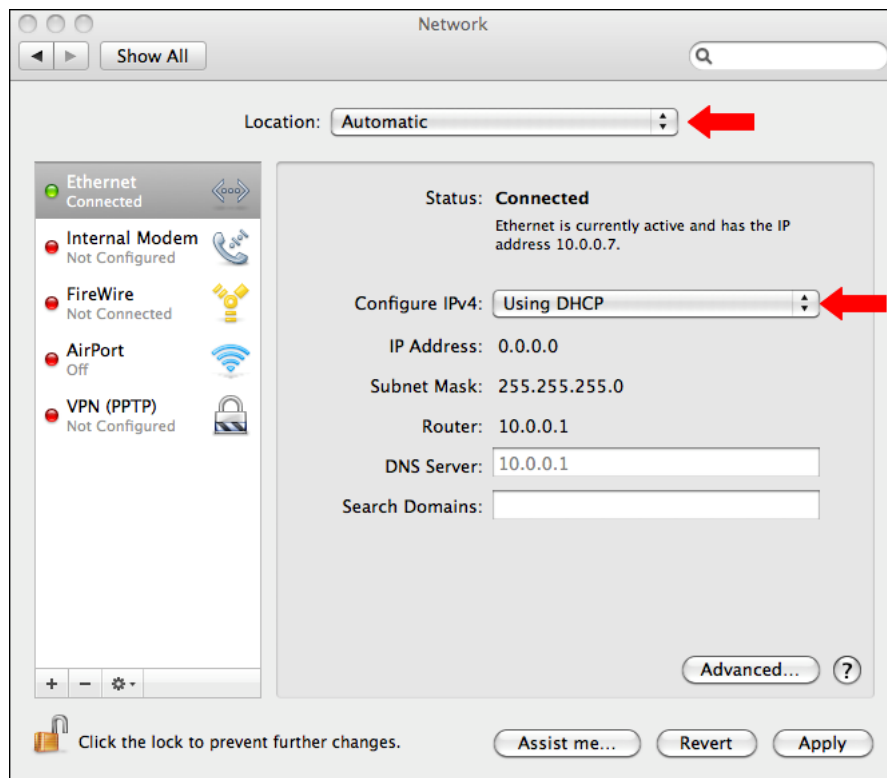

3. Click **Apply**.
4. Restart the computer.

LAN Settings

By default, the High-speed LAN has a gateway of 192.168.6.1 and assigns IP addresses in the 192.168.6.50-150 range. If this configuration conflicts with an existing onboard network, you may change the settings at the TracPhone V7-HTS web interface (see below). The Unlimited LAN (gateway 192.168.5.1) cannot be changed; if it conflicts with an existing network, please contact KVH Technical Support.

Important!

The default LAN settings work well for most installations. Do not change these settings unless absolutely necessary.

NOTE: If the optional CommBox software is enabled, the Network Settings page of the ICM will not contain any configurable fields.

To change the ICM's High-speed LAN settings, follow these steps:

1. At the TracPhone V7-HTS web interface, click the **Settings** tab. Then click **Network Settings**.
2. In LAN Settings, click **Edit**.
3. If the Login window appears, log in with the Administrator password.
4. Modify the IP Address, Subnet Mask, and DHCP Mode settings as necessary.
5. Click **Save**.
6. At the confirmation message, click **Save**.

Figure 7-22 LAN Settings

LAN Settings	
IP Address:	192 . 168 . 6 . 1 <small>Note: 192.168.0.1 is reserved for system use. Be sure to assign a different IP address.</small>
Subnet Mask:	255 . 255 . 255 . 0
DHCP Mode:	<input checked="" type="radio"/> Enabled (default) <input type="radio"/> Disabled
	DHCP Start: 192 . 168 . 6 . 50
	DHCP End: 192 . 168 . 6 . 150
Reset to Defaults <input type="button" value="Cancel"/> <input type="button" value="Save"/>	

Cache Settings

By default, the local web cache is enabled on the ICM. This feature allows the ICM to temporarily store the content of web pages you visit, so they will load faster on subsequent visits. The local web cache should stay enabled to ensure the best possible web browsing experience. However, it can be disabled if necessary.

Important!

Do not change the cache settings unless absolutely necessary.

NOTE: If the optional CommBox software is enabled, the Network Settings page of the ICM will not contain any configurable fields.

To disable the local web cache on the ICM, follow these steps:

1. At the TracPhone V7-HTS web interface, click the **Settings** tab. Then click **Network Settings**.
2. In Cache Settings, click **Edit**.
3. If the Login window appears, log in with the Administrator password.
4. Select **Disabled**.
5. Click **Save**.
6. At the confirmation message, click **Save**.

Figure 7-23 Cache Settings

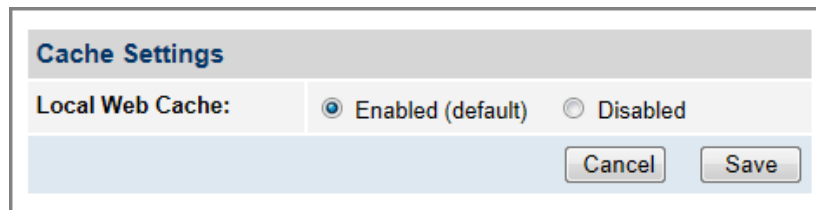

Cache Settings

Local Web Cache: Enabled (default) Disabled

Cancel Save

Setting Up Data Usage Alerts

You can set up automatic email alerts to notify you (and others of your choosing) when your vessel's data usage reaches certain thresholds, and prevent surprises on your airtime bill. At your option, alerts can be sent when the vessel has consumed a certain percentage of its monthly allowance and/or when usage exceeds that monthly allowance by a certain amount of your choosing.

To set up alerts, log into the mini-VSAT Manager (www.mykvh.com), go to the Terminal > Data Plan section of the Vessel Details page, and select **Manage Alerts**.

Figure 7-24 Managing Alerts at mini-VSAT Manager (Example)

Manage Alerts

Allowance Alerts

Send alerts when usage **reaches** the following thresholds of Monthly Allowance:

50%
 80%
 100%
 200%
 300%

Overage Alerts

Send alerts when usage **goes over** the Monthly Allowance by the following amount:

Every

Who To Notify

Email

Email Address

master_satisfaction@kvh.com ×

Text / SMS

Phone number

+1 401-555-1212 ×
 +1 401-555-0000 ×

or

Email and SMS notifications are provided as a courtesy only to assist you in managing your data usage. In the event that you do not receive a notification, you will remain responsible for all airtime charges, even if such charges exceed your plan allowance.

CommBox Settings

If the optional CommBox software is enabled, the ICM's network settings are configured by KVH over the air. The Network Settings page of the ICM and mini-VSAT Manager will not contain any configurable fields.

NOTE: See "CommBox Features" on page 106 for details on enabling the CommBox software.

For complete details about the CommBox software, refer to the CommBox manual. To view the CommBox manual, follow these steps:

1. At the TracPhone V7-HTS web interface, click the **CommBox** tab.

Figure 7-25 CommBox Tab



2. Click **Log in to CommBox Control**.
3. Log into the CommBox web page with your CommBox user name and password.

NOTE: The CommBox user name and password differs from the ICM's Administrator password.

4. At the CommBox web page, click the **Help** tab.

Figure 7-26 CommBox Help Tab

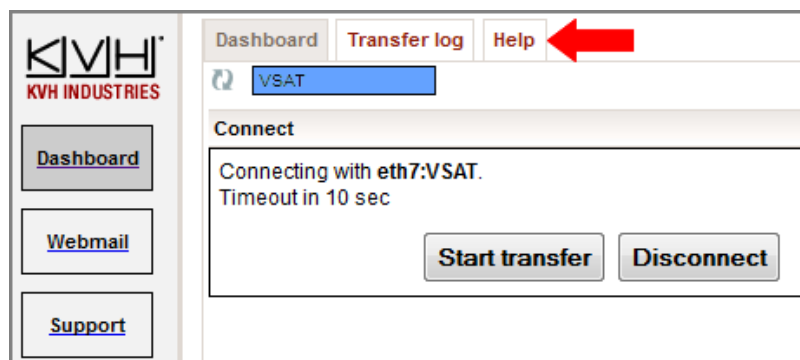

Reset to Factory Configuration

If the system's network becomes corrupted such that you can no longer access the TracPhone V7-HTS web interface, and KVH Technical Support is unable to access the system remotely, you can reset the system to its original factory settings.

Important!

Perform a factory reset only if directed by KVH Technical Support. This function should only be used as a last resort when all other options fail.

The following settings are included in the reset:

- Reverts to Standard HTS network configuration
- Deletes any custom CommBox configurations
- Clears any configured no-transmit zones
- Sets the ICM's LCD brightness to High

To reset the system to its factory settings, follow these steps:

1. At the ICM's front panel, press **MENUS** until the display shows "DIAGNOSTIC TOOLS."
2. Press **ACCEPT**.
3. At "KVH SUPPORT IP," press **NEXT**.
4. At "CALIBRATE GYROS," press **NEXT**.
5. At "FACTORY RESET," press **ACCEPT**.
6. At "PROCEED WITH RESET?," press **ACCEPT**.

The system reverts to its original factory settings. Do not power off the system while this reset is in progress.

Figure 7-27 Factory Reset

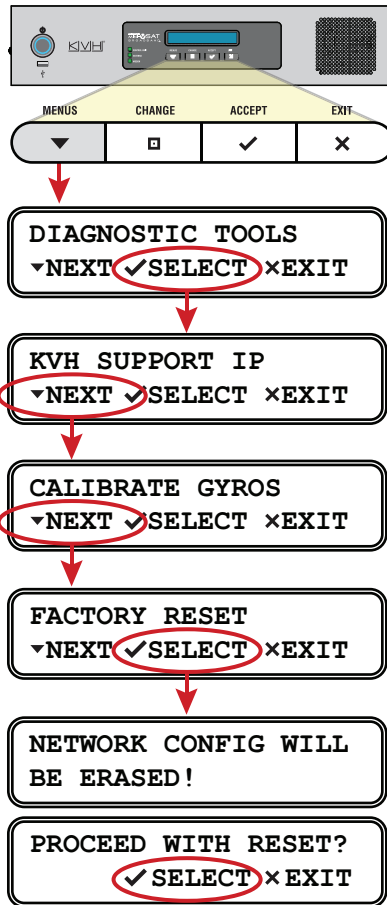

Press **MENUS** until
DIAGNOSTIC TOOLS
is displayed.



8. Data Connections

This section explains how to connect to the Internet via the mini-VSAT Broadband service. It also provides a number of suggestions for minimizing the amount of data that's transferred over the network, and provides an overview of the CommBox and KVH Link options.

Contents

Internet Access Overview	99
Tips for Minimizing Data Usage.....	101
CommBox Features	106
KVH Link Content Services	108

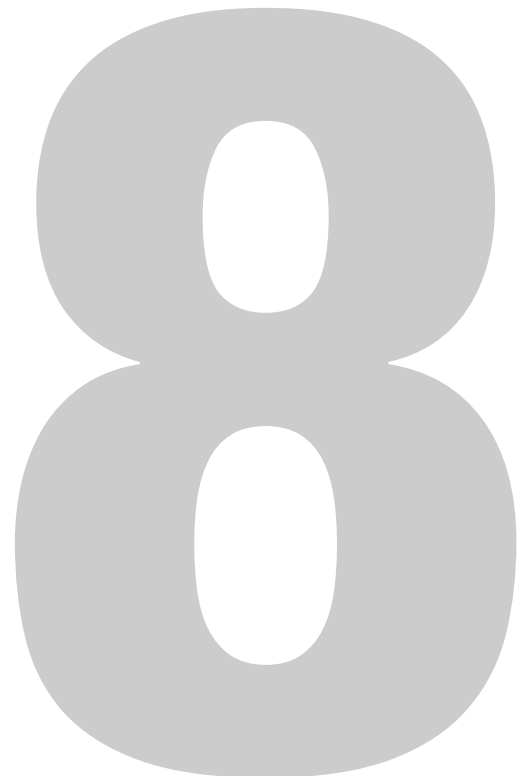



Internet Access Overview

While the TracPhone system is online with the mini-VSAT Broadband service, you can perform all of the same Internet tasks you perform at home:

- Email
- Web browsing
- Weather and chart updates
- Instant messages
- Corporate network access (VPN)
- Data transfers

Important!

High-bandwidth applications, such as peer-to-peer file sharing, web cameras, streaming media, and high-speed gaming, are not supported by fixed rate plans. For details, be sure to read all of the service terms and conditions in the End User Agreement, which can be found at www.kvh.com/mvbcustomercenter.

Connecting to the Internet

To connect to the Internet, follow these steps:

1. Make sure the TracPhone system is online.
2. Open a web browser window on any device connected to the vessel's network.
3. If a login screen appears, log in with your username and password. Then set the slider to the desired duration of your session and click **Start Internet Connection**. When you are done using the Internet, click **Disconnect & Log Out**.

Figure 8-1 User Login

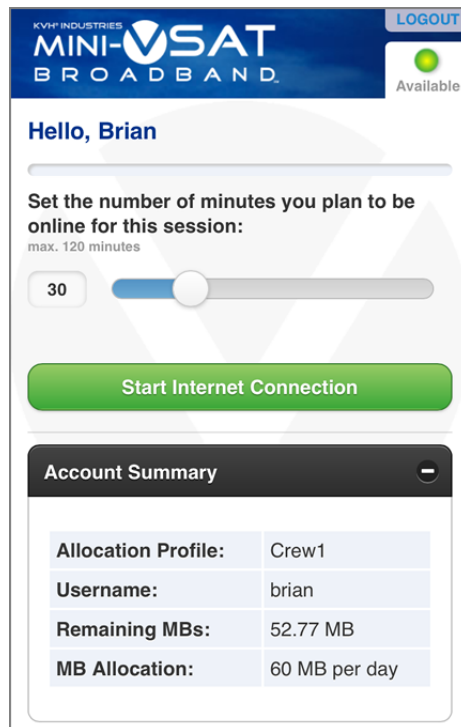

KVH INDUSTRIES
MINI-SAT
BROADBAND

LOGOUT Available

Hello, Brian

Set the number of minutes you plan to be online for this session:
max. 120 minutes

30

Start Internet Connection

Account Summary

Allocation Profile:	Crew1
Username:	brian
Remaining MBs:	52.77 MB
MB Allocation:	60 MB per day

NOTE: For details on configuring users, see [“Standard HTS Configuration”](#) on page 74.

4. If you're unable to connect with a computer, make sure it is configured for DHCP addressing. Refer to [“Configuring Computers for DHCP”](#) on page 85.

Tips for Minimizing Data Usage

The configurations of operating systems, web browsers, and applications generally assume the unlimited, always-on broadband connection that is a reality on land. As such, they will often try to connect to the Internet on their own to download updates and transfer files. They will also operate without any regard to the amount of traffic they generate to perform routine tasks.

While high data usage is not much of a concern with a broadband connection on shore, avoiding excessive data usage is worthwhile when using the mini-VSAT Broadband service at sea, especially if you are charged by the megabyte.

Consider the guidelines in this section to eliminate unnecessary background Internet activity and minimize the amount of data you consume. Adopting these guidelines will help ensure you use the service in the most efficient and cost-effective manner.

Important!

You are responsible for **all** data transferred to/from your network devices, including inadvertent downloads by applications running in the background.

NOTE: At the mini-VSAT Manager, you can set up alerts to notify you when your vessel's data usage reaches certain thresholds. You can also block or restrict certain types of data usage. For example, restricting Bulk Transfer and Network Storage categories will help minimize inadvertent background data. Refer to mini-VSAT Manager Help for details.

Preventing Automatic Updates

The default configuration of many applications allow them to download updates from the Internet automatically, without any user interaction. KVH recommends that, while the device is being used at sea, you set up these applications either to not check for updates or to notify you before downloading them. These applications include:

- Anti-virus software
- Spyware protection software
- Web browser
- Mobile apps
- Adobe Acrobat[®] Reader
- Apple iTunes[®]
- Windows Update or Mac Software Update

NOTE: Android devices offer a “Restrict Background Data” setting, which will prevent background updates from all installed apps.

Any malicious applications hidden on your device may also use your Internet connection without your knowledge. Therefore, prior to using your device onboard the vessel, run a full system scan with an up-to-date anti-virus and spyware detection/removal utility.

Disabling Automatic File Backup and Synchronization

The default configuration of many cloud-based file sharing and syncing tools allow them to upload files (including photos, videos, and other media) and synchronize mobile devices without any user interaction. KVH recommends that, like preventing automatic updates, you set up these services for manual backup and synchronization only. These cloud storage services include:

- Apple iCloud[®]
- Google Drive[™]
- Microsoft OneDrive[®]
- Dropbox[™]
- Box

Firewall Protection

A firewall can prevent most applications from accessing the Internet without your knowledge, as well as protect your devices from outside intrusion. KVH recommends that you enable the firewall on your router or individual network devices.

Web Browser Settings

All popular web browsers, such as Internet Explorer, Mozilla Firefox, Google Chrome, and Apple Safari, offer various tools that allow you to minimize the amount of data they consume. Consider these options:

Limit Multimedia Downloads

Set up your browser to disable multimedia content embedded in websites from playing automatically.

Enable Pop-Up Blocker

Many consumer websites overlay small pop-up windows over the main page to launch ads. Turn on your web browser's pop-up blocker to prevent these from running and consuming data. Your web browser might also offer tools to block websites or types of content that you specify, or allow access to only certain websites that you trust.

Maximize Caching of Web Pages

By default, web browsers automatically refresh the content they have stored in their cache. If the browser finds a new version of a website is available, it will delete the version it has stored locally and download the new one. KVH recommends you set up your browser to download new versions of web pages only when you visit them, and also increase the size of the cache to the maximum level permitted for your browser.

Disable Preloading of Web Pages

The mobile version of Google Chrome (the default browser on Android devices) speeds up web browsing by preloading the destination web pages of links shown on the currently viewed page. This feature consumes an enormous amount of data and should be disabled.

Avoid Multiple Browsing Tabs

KVH recommends that you browse the web using a single open browser tab. Any tabs left open in the background may continue to consume data.

Data-Intensive Applications

The following applications can consume a great deal of data whenever they are active or running in the background:

- Skype (*uses 40 MB per month just to maintain your status, in addition to the data used for actual calls and chats*)
- RSS feeds and widgets presenting real-time information (*e.g., news, weather, stocks ticker, sports scores, etc.*)
- Social media (*e.g., YouTube and Facebook*)
- Peer-to-peer (P2P) file sharing (*e.g., BitTorrent, Gnutella, etc.*)

If you are charged by the megabyte on a metered rate plan, use caution when running these types of applications to help prevent unpleasant surprises on your airtime bill.

Important!

Some high-bandwidth applications, such as peer-to-peer file sharing, web cameras, streaming media, and high-speed gaming, are not supported by fixed rate plans. For details, be sure to read all of the service terms and conditions in the End User Agreement, which can be found at www.kvh.com/mvbcustomercenter.

Mobile Websites

Many organizations now offer alternative versions of their websites optimized for mobile devices. Although designed for smartphone users on a cellular connection, you can access these mobile websites on a desktop or laptop as well. KVH recommends you visit mobile websites instead of full sites whenever possible to minimize the amount of data used.

To view the mobile version of a website, simply replace the “www” in the address with an “m”. For example, to view the mobile version of CNN’s website, you would enter “m.cnn.com” in your web browser.

Disabling Wi-Fi Access on Mobile Devices

If you don’t intend to use your mobile device to access the Internet over the mini-VSAT Broadband service, disable the mobile device’s automatic Wi-Fi connection to the ICM’s wireless network.

Email Best Practices

There are several ways to reduce the amount of data your email application uses. Consider the following email best practices:

- Use an IMAP (Interactive Mail Access Protocol) server instead of traditional POP3 (Post Office Protocol 3).
- Disable automatic sending/receiving of new mail.
- Send messages in plain text rather than HTML format.
- Compress all attachments.
- Disable automatic signatures and read receipts.

CommBox Features

The optional CommBox software extends the network capabilities of the ICM to improve crew morale, streamline operations, improve efficiency, and reduce costs. Two options are available:

- **CommBox Standard Bundle** (KVH part no. 35-0010): Provides least cost routing, onboard firewall, web caching, web image compression, ad removal, and URL and content filtering
- **CommBox Enterprise Bundle** (KVH part no. 35-0011): Provides everything included in the Standard bundle, plus automated file transfers, differential synchronization, mail relay server, web mail client, anti-spam and anti-virus filters, roaming crew accounts, and prepaid Internet and email services

NOTE: The CommBox Enterprise Bundle requires integration with a CommBox hub.

Purchasing a CommBox Bundle

To learn more about CommBox's powerful suite of network management features, go to the TracPhone V7-HTS web interface and click the **CommBox** tab. Then contact KVH Network Services at networkservices@kvh.com for a consultation. KVH will coordinate with you to select, install, and configure the appropriate bundle to meet your needs.

Accessing the CommBox Web Interface

If a CommBox software bundle is enabled on the ICM, follow these steps to access the CommBox web interface:

1. At the TracPhone V7-HTS web interface, click the **CommBox** tab.

Figure 8-2 CommBox Tab



2. Click **Log in to CommBox Control**.
3. Log into the CommBox web interface with your CommBox user name and password.

NOTE: The CommBox user name and password differs from the ICM's Administrator password.

For more details about how to use the CommBox, refer to the CommBox manual available on the **Help** tab of the CommBox web interface.

Figure 8-3 CommBox Help Tab

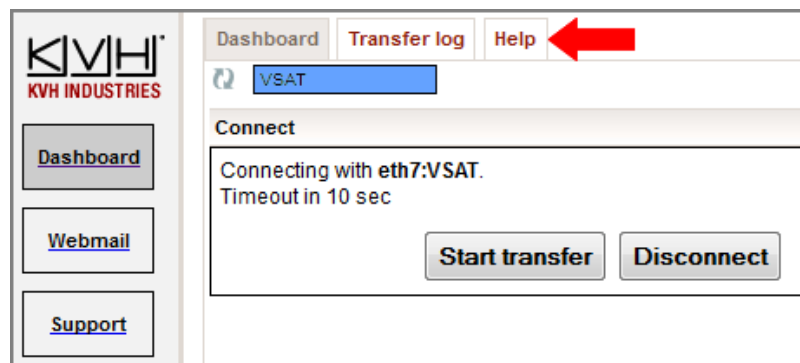

KVH Link Content Services

KVH Link delivered by IP-MobileCast offers licensed entertainment to commercial vessels at sea without using your monthly data plan or slowing down onboard connections to the Internet. Content may include movies, TV shows, daily print and video news, sports highlights, music, karaoke, and podcasts, depending on the vessel's subscription. KVH Link also offers large file delivery services for critical ship operations, including chart updates, weather data, company communications to the crew, and crew training.

Figure 8-4 KVH Link Interface

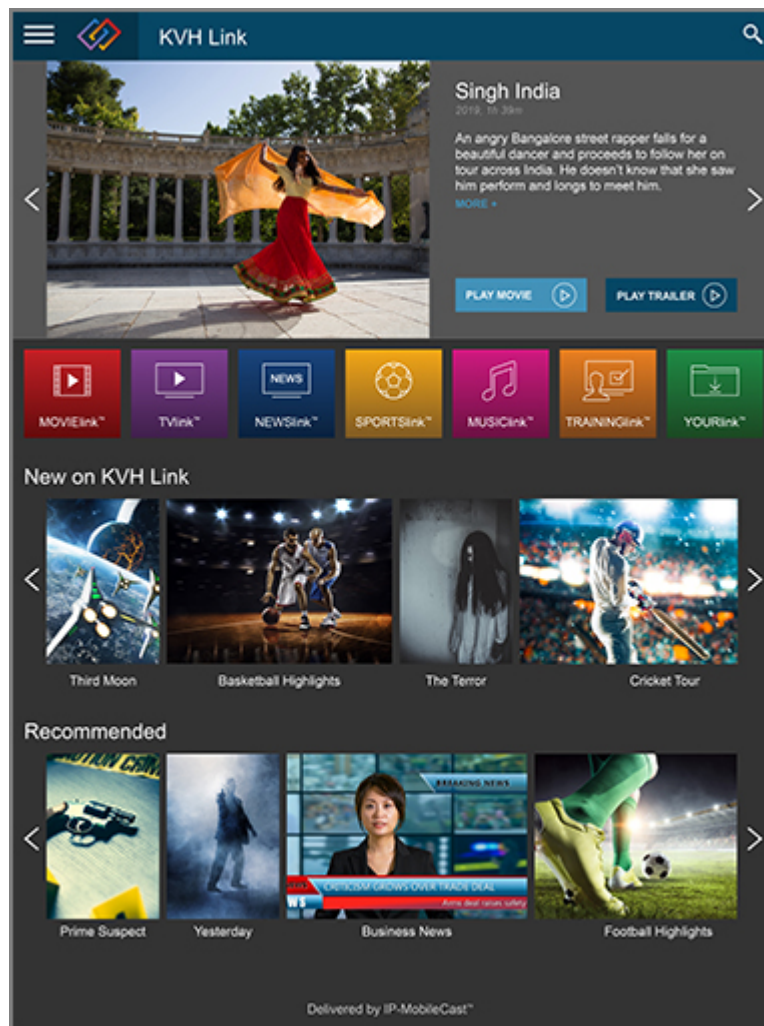

The ICM stores all KVH Link content and streams it locally to connected shipboard devices without the need for a dedicated media server. Viewing on a TV is supported by the KVH Link Set-top Box (KVH part no. 72-0876), which can be installed by the crew. Refer to the KVH Link User's Guide for details. To learn more about KVH Link, visit kvh.com/link.

Accessing KVH Link Content

If your vessel has subscribed to a KVH Link entertainment service, you can access its content using any of the following devices:

Device	App or Browser
Windows 7+	Chrome, Firefox
MacOS 10.10+	Chrome, Firefox
Android 6+	KVH Link App, Chrome
Apple iOS 10+	KVH Link App
TV with KVH Link Set-top Box	KVH Link Set-top Box App

Important!

The TracPhone system must be continuously powered on and connected to the mini-VSAT Broadband network, both to receive the latest content and to support user playback.

Option 1: Mobile App on Smartphone or Tablet

1. First, install the KVH Link app on your Apple iOS or Android mobile device. You can download the app for free from the Apple App Store or Google Play Store (*data fees may apply*).
2. Connect your device via Wi-Fi to the vessel's network that is connected to the ICM.
3. Launch the KVH Link app.

Option 2: Web Browser on Computer or Android Smartphone or Tablet

NOTE: Movies and TV shows cannot be viewed in a web browser on an Apple iPhone or iPad. You need to use the free KVH Link iOS app.

1. Connect your Windows or Mac computer, or your Android smartphone or tablet, to the vessel's network that is connected to the ICM.
2. Using a compatible browser (e.g., Chrome), go to <https://ipmobilecast.com>.

Option 3: KVH Link Set-top Box Connected to a TV

NOTE: To install the KVH Link Set-top Box (KVH part no. 72-0876), refer to the detailed instructions provided with the Set-top Box.

1. Turn on the TV and select the HDMI input that is connected to the Set-top Box.
2. Press the power button on the Set-top Box remote control. The status light on the front of the Set-top Box should be lit blue and a splash screen should appear on the TV.
3. Once the KVH Link app has loaded, use the arrows, back, and OK buttons on the remote control to navigate the onscreen menus, browse titles, and play content.
4. When you are done using the Set-top Box, you can set it to standby mode by pressing the power button on the remote control.

Figure 8-5 KVH Link Set-top Box Remote Control

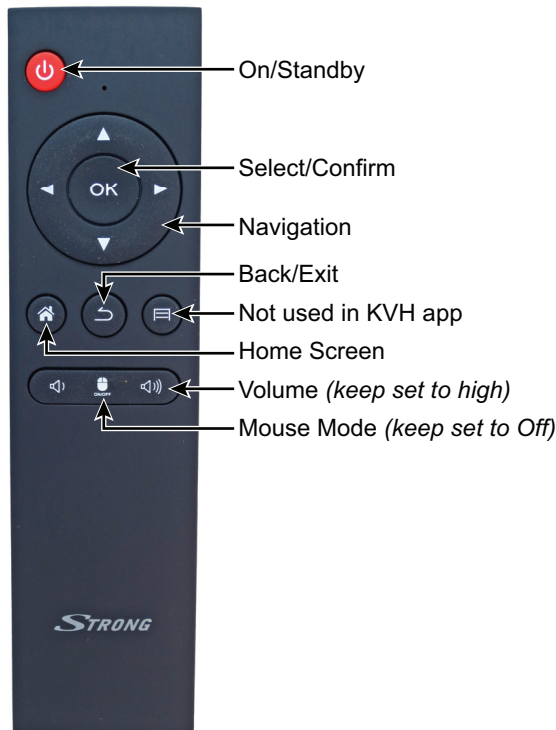

Accessing KVH Link Documentation

The user documentation for KVH Link is accessible from the KVH Link app and web interface. Click or tap the menu button in the upper left corner and select **Help > Support Documents (PDFs)**.

Figure 8-6 KVH Link Help

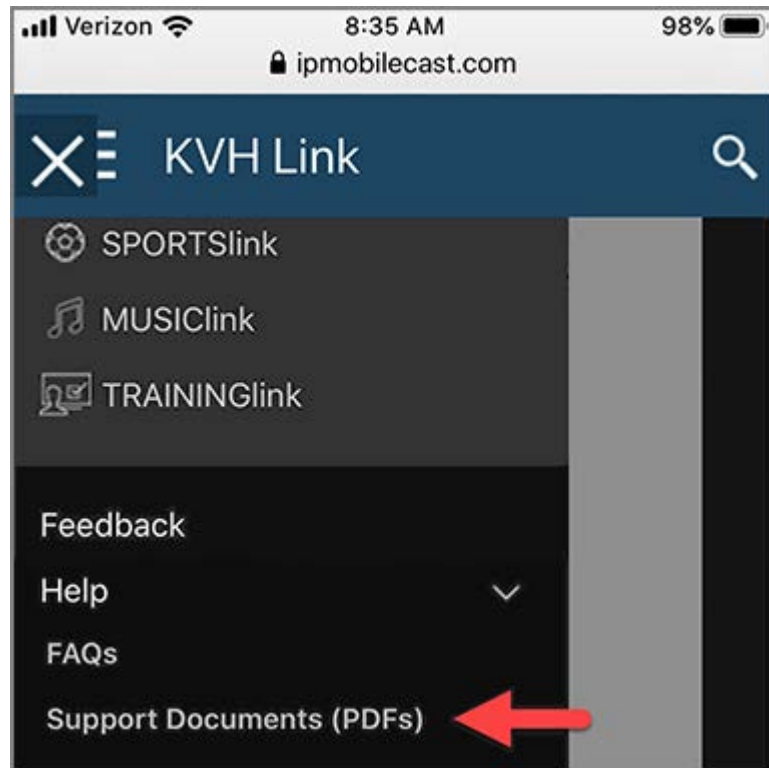



9. Troubleshooting

This section identifies some basic problems along with their possible causes and solutions. It also explains what the error messages, status messages, and LED conditions indicate, how to view and export the system logs, and how to get support.

Contents

Initial Steps for Any Problem	115
Troubleshooting a Voice Problem	117
Troubleshooting a Data Problem	119
Error and Warning Messages	121
Status Information	126
LED Indicators	136
System Logs	138
Equipment ID Numbers.....	140
Software Versions	141
OneCare Customer Support.....	142



Initial Steps for Any Problem

If you are experiencing a problem with your TracPhone system, first follow these basic steps:

Step 1a: Check System Status Information on the Web Interface

Open a web browser window on any computer on the network and enter **http://minivsat.kvh** to access the TracPhone V7-HTS web interface.

NOTE: This web address may not work on all platforms and browsers. It also will not work in certain network configurations. If the web interface does not appear, enter the ICM's IP address instead (default is 192.168.6.1). You can find this address on the ICM front panel LCD (go to Settings > Network Settings > IP Assignments).

The Home page provides system status information. Check the following:

- **Connection Status:** "Online" indicates the system is connected to the mini-VSAT Broadband service.
- **Antenna State:** "Tracking" indicates the antenna is tracking the satellite.
- **My Phone:** "Online & Ready" indicates the ICM's built-in MTA is connected to the enhanced voice service.

If a status message differs from the normal indications listed above, refer to ["Status Information" on page 126](#). If an error message is displayed, refer to ["Error and Warning Messages" on page 121](#).

Step 1b: Check System Status Information on the ICM Front Panel

If you are unable to connect to the web interface, you can find similar status information on the front of the ICM. Check the following:

- **ICM LCD:** "Online Tracking" indicates the system is connected to the mini-VSAT Broadband service and the antenna is tracking the satellite.
- **LEDs:** All LEDs should be lit green.

If a status message differs from the normal indication listed above, refer to ["Status Information" on page 126](#). If an error or warning message is displayed, refer to ["Error and Warning Messages" on page 121](#). If an LED is not lit green, refer to ["LED Indicators" on page 136](#).

Step 2: Check for Blockage

If the antenna is continuously searching for the satellite, check the area around the antenna for blockage. The antenna needs an unobstructed view of the sky to receive satellite signals. Common causes of blockage include other onboard masts or structures, severe weather, and nearby buildings, bridges, trees, or other vessels.

NOTE: You can determine which direction the antenna is pointing by viewing the Home page on the web interface or the "CURRENT AZ/EL" status message on the ICM front panel LCD (go to Status > Antenna/ACU Status > Current Az/El).

If there is no blockage, you might be located outside of the mini-VSAT Broadband service coverage area (for a coverage map, visit www.kvh.com/minivsatmap). If there is partial blockage causing intermittent antenna performance, you can set up a tracking avoidance zone to avoid tracking in that direction (see "Setting Up Tracking Avoidance Zones" on page 44).

Step 3: Try Accessing the KVH Test Page

Try accessing the KVH test page at <http://test.minivsat.net> (*only works via mini-VSAT Broadband*). If the KVH test page appears in your browser, but you still can't access any other web page, there might be an account or hub issue – contact KVH Technical Support (see "Contacting KVH Technical Support" on page 143).

Step 4: Check Power and Cables

Make sure power is applied to all system components. Also make sure all cables are connected tightly.

Step 5: Restart the System

Try restarting the system at the TracPhone V7-HTS web interface (see "Hardware Restart" on page 155). If you cannot access the web interface, turn off the ICM at the front panel, then turn it back on.

Troubleshooting a Voice Problem

If you are unable to make a voice call, follow these steps:

Step 1: Check the Basics

Complete the initial steps described in [“Initial Steps for Any Problem” on page 115](#).

Step 2: Make Sure You Are Dialing the Number Properly

As explained in [“Making a Ship-to-Shore Call” on page 56](#), if you are dialing a number outside the country assigned to Line 1, you need to dial the appropriate international prefix and country code, in addition to the area/city code and local phone number. For example, if your Line 1 is assigned a United States phone number and you are calling a number outside of the U.S., you need to dial 011 + Country Code + Area Code + Local Phone Number.

Step 3: Check the My Phone Status on the Web Interface

At the TracPhone V7-HTS web interface, go to the Home page and check the My Phone status information. If it shows “Unable to Register Voice Service,” there is an account or activation issue - contact KVH Technical Support (see [“Contacting KVH Technical Support” on page 143](#)). The My Phone status also shows the status of the phone lines.

Step 4: Restart the MTA

The MTA built into the ICM might need to download an updated configuration file from the network. Try restarting the MTA at the TracPhone V7-HTS web interface (see [“Hardware Restart” on page 155](#)).

Step 5: Verify the MTA Obtained an IP Address

The MTA built into the ICM must receive an IP address from the ICM in order to provide a voice connection. Pick up the handset on any phone connected to the ICM and press ***1 on the keypad. If you hear “0.0.0.0” in the handset, the MTA did not receive a valid IP address. Contact KVH Technical Support for assistance (see [“Contacting KVH Technical Support” on page 143](#)).

Step 6: Try a Different Phone

Disconnect the phone from the ICM and connect another phone in its place (use a phone that you know is working properly). If you are then able to place a call with the new phone, the phone you were using is faulty.

Step 7: Verify the Phone Is Connected Properly

Make sure your phone is connected to one of the active RJ11 "Voice Line" jacks on the ICM ("Voice Line 1" is the primary jack). If you are not receiving calls as expected via a virtual number, make sure your phone is connected to the "Voice Line" jack that is assigned that virtual number.

Troubleshooting a Data Problem

If you are unable to access the Internet, follow these steps:

Step 1: Check the Basics

Complete the initial steps described in [“Initial Steps for Any Problem” on page 115](#).

Step 2: Check Your Computer's DHCP Configuration

Unless you have set up a static IP address, your computer's TCP/IP settings need to be configured for DHCP addressing, which allows the ICM to assign it an IP address. Refer to [“Configuring Computers for DHCP” on page 85](#) for details.

Step 3: Try a Direct Wired Connection

Connect your computer directly to the “User Ethernet 1” port on the back of the ICM using an Ethernet cable. Then restart your computer. If you are now able to access the Internet, there is a problem with your vessel's network.

Step 4: Ping the Network Connections

The Ping command sends a test packet to any IP address you choose and reports how long it takes to receive a response.

To send a Ping on a Windows PC:

Open a Command Prompt window (*press Windows Logo key + R, then type cmd*). Then, at the command prompt, type **ping <IP address>**.

To send a Ping on a Mac:

Open the Network Utility (*go to Finder > Utilities > Network Utility*). Then, in the Ping tab, type the IP address then click **Ping**.

Ping the IP address of the ICM. You can find the IP address on the front panel LCD (*go to Settings > Network Settings > IP Assignments*). The default IP address is **192.168.6.1**. All packets sent should be received. If packets are lost, your computer is not connected properly to the ICM.

Ping **4.2.2.1** to check your connection to the Internet. All packets sent should be received within 580-900 ms. If the ping fails, contact KVH Technical Support (see [“Contacting KVH Technical Support” on page 143](#)).

Figure 9-1 Pinging the Network Connections

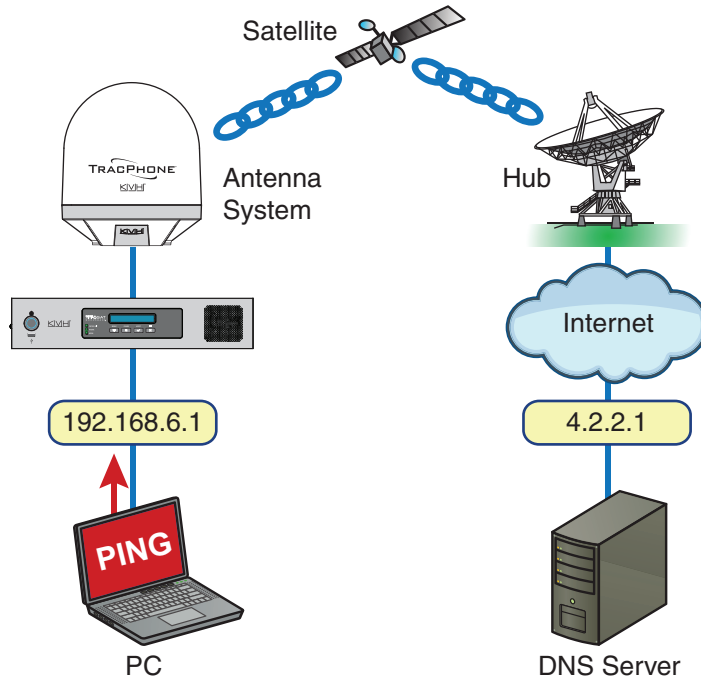

Error and Warning Messages

This section lists the error and warning message codes that might appear on the TracPhone V7-HTS web interface, front panel LCD, and/or system logs to indicate a system problem. Many of these faults should only be repaired by a KVH-certified technician; contact KVH Technical Support for assistance (see [“Contacting KVH Technical Support”](#) on page 143).

No.	Description
100	Error: There is an open circuit in the antenna power/data cable. Check the cable.
101	Error: There is a short circuit in the antenna power/data cable. Check the cable.
102	Warning: The ICM is not providing the proper DC power to the antenna. Check the wires on the back of the ICM.
103	Warning: A software update file was not found on the USB device. Try these steps: <ul style="list-style-type: none">• Remove the USB device from the ICM, wait 10 seconds, then reinsert it.• Verify that a valid TracPhone V7-HTS update file is present on the USB device in its root directory.• Replace the update file on the USB device with a new file.• Use a different USB device.
104	Warning: The software update file you selected is corrupt. Try a new update file.
105	Warning: The ICM is unable to read from or write to its internal memory (EEPROM). Contact KVH.
106	Error: The ICM has lost communications with the antenna. Try these steps: <ul style="list-style-type: none">• Check the wiring on the back of the ICM.• Check the antenna power/data cable.• Try turning the system off, then back on.

No.	Description
107	<p>Warning: The ICM's internal temperature exceeds acceptable limits. Try these steps:</p> <ul style="list-style-type: none"> • Listen for the cooling fan inside the ICM. If you don't hear the fan, contact KVH. • If you hear the cooling fan, turn off the system and allow it to cool down. Then vacuum the ICM's vents (see "Preventative Maintenance" on page 147). • If the problem persists, you might need to relocate the unit to an area that provides better ventilation.
111	<p>Warning: The ICM is unable to initialize its built-in wireless access point (WAP). Contact KVH.</p>
112	<p>Warning: There is an internal fault in the ICM. Contact KVH.</p>
117	<p>Error: There is an open circuit in the transmit (TX) RF cable. Check the cable. If the cable is OK, the BUC might be faulty – contact KVH.</p>
118	<p>Error: There is a short circuit in the transmit (TX) RF cable. Check the cable. If the cable is OK, disconnect the cable from the ICM and turn the ICM off, then back on. If the error persists, there is an internal fault in the ICM. If the error disappears, the BUC might be faulty. Contact KVH.</p>
120	<p>Warning: The internal temperature of the ICM's built-in modem exceeds acceptable limits. Try these steps:</p> <ul style="list-style-type: none"> • Listen for the cooling fan inside the ICM. If you don't hear the fan, contact KVH. • If you hear the cooling fan, turn off the system and allow it to cool down. Then vacuum the ICM's vents (see "Preventative Maintenance" on page 147). • If the problem persists, you might need to relocate the unit to an area that provides better ventilation.
121	<p>Error: The ICM is not receiving satellite signal strength (RSSI) data from its built-in modem. Try these steps:</p> <ul style="list-style-type: none"> • Turn the ICM off, then back on. • Check the ICM jumper cable. • If the error persists, contact KVH.
122	<p>Error: The ICM's built-in modem is not communicating. Try these steps:</p> <ul style="list-style-type: none"> • Check the ICM jumper cables. • Try turning the ICM off, then back on. • If the error persists, contact KVH.

No.	Description
123	Error: The ICM's built-in modem is not responding to status queries. Contact KVH.
124	Warning: The software update file you selected is not valid for the TracPhone V7-HTS. Try a new update file.
125	Warning: The ICM has lost communications with the GPRS modem (remote service & support module) inside the antenna. Check the power/data cable and the wires on the back of the ICM.
127	Error: The antenna is not accepting the no-transmit zones setup from the ICM. Contact KVH.
128	Warning: The software update failed. Retry updating the software. If it fails again, check the power/data cable and the wires on the back of the ICM.
129	Error: The ICM has lost internal communications of satellite signal strength (RSSI) data. Contact KVH.
130	Error: The ICM is incompatible with the antenna's LNB. Either the ICM or the LNB is configured for HTS, while the other is not. Contact KVH.
131	Error: The antenna is running a version of software that does not work properly with the ICM. Update the software.
132	Error: The ICM has detected a SATADOM filesystem corruption and is operating in Rescue Mode. Contact KVH.
133	Warning: The software update failed due to a missing component on the ICM. Contact KVH.
134	Warning: The software update failed due to a file extraction error. Contact KVH.
135	Warning: The software update failed due to insufficient disk space. Contact KVH.
200	Warning: The antenna is not receiving adequate DC power from the ICM. Check the power/data cable and the wires on the back of the ICM.
204	Error: The antenna's main board has lost RF communications. Try updating the software (see "Software Updates" on page 149).

No.	Description
206	Error: The antenna's azimuth motor or limit switch failed. Contact KVH.
208	Error: The antenna's elevation motor or limit switch failed. Contact KVH.
216	Error: The antenna's cross-azimuth motor or limit switch failed. Contact KVH.
218	Error: The antenna's skew motor or limit switch failed. Contact KVH.
219	Error: One of the antenna's gyros is out of calibration. Contact KVH.
220	Warning: One of the antenna's gyros failed. Contact KVH.
221	Error: The system is not receiving any GPS data. Contact KVH.
222	Warning: The antenna's internal temperature exceeds acceptable limits. Turn off the system and allow it to cool. If the problem persists, contact KVH.
234	Error: The antenna is not receiving satellite signal strength (RSSI) data from the ICM. Try these steps: <ul style="list-style-type: none"> • Turn the ICM off, then back on. • Check the wires on the back of the ICM. • Check the power/data cable.
235	Error: The antenna has lost RF communications. Contact KVH.
240	Error: The antenna's LNB is not receiving the proper power from the ICM's receive (RX) RF cable. Check the RX RF cable.
241	Error: The antenna's main board detects a power failure. Contact KVH.
265	Warning: The GPS is unable to acquire a fix. Check for blockage or RF interference around the antenna.
269	Error: The antenna cannot determine which type of LNB is installed. Either the LNB type was not programmed at the factory, or the antenna's memory (EEPROM) has been cleared or corrupted. Contact KVH.
270	Error: The ICM is running a version of software that does not work properly with the antenna. Update the software.

No.	Description
271	Error: The ICM is incompatible with the antenna's LNB. The LNB is configured for HTS, while the ICM is not. Contact KVH.
404	Warning: Antenna is unwrapping its coiled internal cable. Normal operation should resume within one minute.
410	Warning: The ICM has lost Ethernet communications with its built-in modem. Check the jumper cable connecting "B1" to "B2" on the back of the ICM.
411	Warning: The antenna cannot find an available service satellite. You are located outside the coverage area.
412	Warning: The ICM is not receiving the proper DC voltage from its power supply. Check the power cable, then contact KVH.
413	Warning: The antenna is waiting for GPS to acquire a fix.
414	Warning: The antenna is using position data from a backup GPS device and not its built-in GPS.
417	Warning: The antenna is pointing in a tracking avoidance zone. Performance might be degraded until the antenna can switch to an alternate satellite or move outside the zone.
418	Warning: The ICM is not receiving status information from the built-in modem. Check the jumper cable connecting "B1" to "B2" on the back of the ICM.

Status Information

You can find system status information on the TracPhone V7-HTS web interface and front panel LCD. Similar information is available in both places. See the following for details:

- [“Status Information on the Web Interface”](#)
- [“Status Information on the ICM Front Panel LCD”](#) on page 132

Status Information on the Web Interface

On the TracPhone V7-HTS web interface, you can view status information on the following pages:

- Home page (see [“Home Page of the Web Interface”](#))
- Support page (see [“Support Page of the Web Interface”](#) on page 129)

Home Page of the Web Interface

The Home page provides basic system status information.

Figure 9-2 Home Page

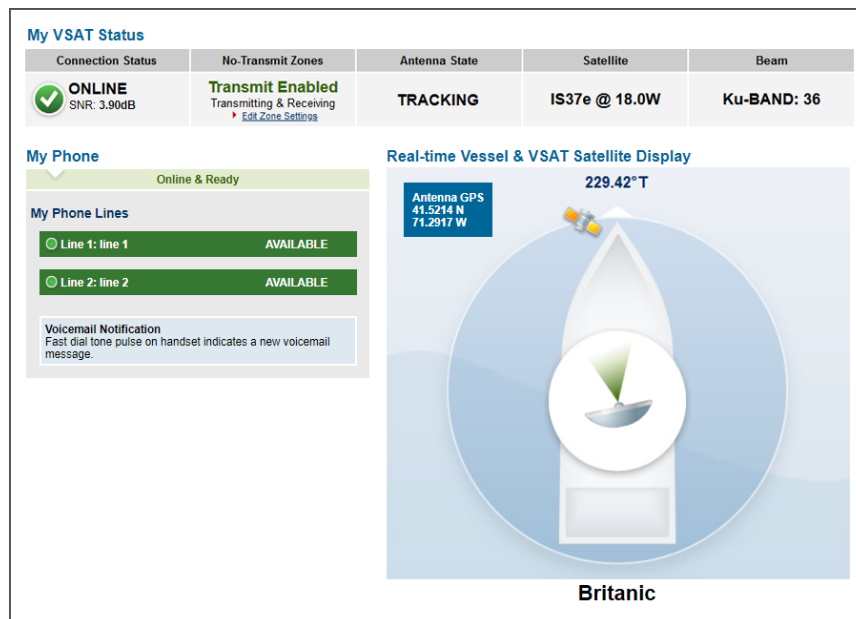

The tables below summarize the status information that is available on the Home page.

My VSAT Status

Message	Description
Connection Status	<p>General status of the modem:</p> <ul style="list-style-type: none"> • Online – Modem is connected to the mini-VSAT Broadband service; the system is ready for use • Offline – Modem is not connected to mini-VSAT Broadband <p>SNR: Quality of the received satellite signal; SNR = Signal level/background noise in decibels</p>
No-Transmit Zones <i>(if zones are set up)</i>	<p>Status of the no-transmit zones:</p> <ul style="list-style-type: none"> • Transmit Enabled (green) – Antenna is not pointing within a no-transmit zone • Transmit Disabled (orange) – Antenna is pointing within a no-transmit zone; zones are being enforced • Transmit Enabled (red) – No-transmit zones are being ignored; antenna can transmit without restriction
Antenna State	<p>General status of the antenna:</p> <ul style="list-style-type: none"> • Tracking • Initializing • Searching • Cable Unwrap – Unwrapping the internal cable; the cable can wrap up to 710° • Waiting for Modem • Idle • Error
Satellite	Satellite that the modem has currently selected for tracking
Beam	Which beam of the tracked satellite the antenna is currently using

My Phone

Message	Description
My Phone	<p>General status of the system's connection to the enhanced voice service:</p> <ul style="list-style-type: none"> • Online & Ready – the voice service is ready for use • Offline • Logging In... • Unable to Connect to Voice Service – Caused by an account or activation error; also displayed during system startup
Line 1/Line 2	<p>General status of the phone lines:</p> <ul style="list-style-type: none"> • Available (green) – the phone line is ready for use • Dialing (green) • Off Hook (green) • Ringing (green) • In Use (orange) – Phone call in progress • Unavailable (gray)

For details on the Real-time Vessel & VSAT Satellite Display, refer to [“Understanding the Home Page” on page 19](#).

Support Page of the Web Interface

The Support page provides more detailed system status information, as reported by the ICM's built-in modem.

Figure 9-3 Support Page

The screenshot displays the Support Page interface with the following sections:

- Support Help:** Includes buttons for Restart Hardware, Help, and System Logs.
- Remote Help Controls:** Shows "No Session in Progress" and provides instructions for contacting KVVH Technical Support.
- My VSAT Status:**
 - Connection Status:** ONLINE (SNR: 6.60dB, Skew: 67.1°, Az: 132.3°, EI: 36.7°)
 - Antenna State:** TRACKING
 - Satellite:** G11 @ 93.1W
 - Beam:** Ku-BAND: 2
 - Frequency:** 12.0304GHz
 - General Statistics Table:**

General Statistics	
Management IP	10.64.14.2
KVVH Support IP	10.224.12.116
Latitude	41.5215N
Longitude	71.2918W
Modem State	IN_NETWORK
Last Login	2019-11-26T14:54:32Z
 - RX Statistics Table:**

FL State	LOCKED
FL Carrier	8PSK 12380 3/5
Composite Power	-41.40
 - TX Statistics Table:**

RL State	ENABLED
RL Carrier	BPSK 652 2/3
Power	33.39dBm
Initial Power	35.09dBm
Max Power	36.00dBm
- Event History:** Lists recent events such as "ACU INTERNAL RSSI COMMS FAILURE" and "SOFTWARE UPDATE SUCCESSFUL".
- System Details:**
 - Software Versions:** Operating System 201, ICM/Antenna 1126140B, Modem 1.6.1.7-132, MTA 9.15.34, CommBox 1.21.0
 - Hardware Information:** Antenna S/N 160500563, ICM S/N 160801124, Modem S/N 86468, Modem DID 335630788, MTA MAC Address 00:10:99:12:00:10
- Position Backup Source:** NMEA 0183, State Not Connected, Latitude ---, Longitude ---
- KVVH Technical Support:**
 - Within the Continental U.S.A.:** Phone: 1 (866) 701-7103, E-mail: mbsupport@kvh.com
 - North/South America, Australia:** Phone: +1 401 851-3806, E-mail: mbsupport@kvh.com
 - Europe, Middle East, Asia, Africa:** Phone: +45 45 160 180, E-mail: mbsupport@kvh.com

The "My VSAT Status" provides the same basic status information as the Home page, with the addition of antenna pointing information: Azimuth (Az), Elevation (El), and Skew. More detailed status information is provided at the bottom of the page.

The tables below summarize the detailed status information that is available on the Support page.

General Statistics

Message	Description
Management IP	The built-in modem's external satellite IP address: 10.64.xxx.xxx ; its identity on the mini-VSAT Broadband network
KVH Support IP	The IP address assigned to the system for remote diagnostics by KVH Technical Support
Latitude	Vessel latitude reported by the GPS
Longitude	Vessel longitude reported by the GPS
Modem State	Status of the modem network connection: <ul style="list-style-type: none"> • In Network – Normal bidirectional network operation; fully logged in • In Acquisition – Intermediate state • Waiting for Acquisition – Intermediate state • Detected – Intermediate state • Waiting for RX Lock – Satellite is not acquired • RX Only – For example: when in multicast mode • Wrong Network – Not configured/authorized for network • Recovery Stack - (<i>reason</i>) – Cannot enter network due to reason provided
Last Login	Date/time of the last successful login to the network

RX Statistics

Message	Description
FL State	State of the forward link; should be "Locked" while the modem is logged in
FL Carrier	Current satellite's forward link modulation, symbol rate (kilo-symbols/sec), and code rate
Composite Power	Measure in dBm of raw satellite signal received at the modem; typical range is -30 to -60 dBm

TX Statistics

Message	Description
RL State	<ul style="list-style-type: none"> • Enabled – Return link is tracking the satellite • Disabled – Return link is pointing within a configured no-transmit zone
RL Carrier	Current satellite's return link modulation, symbol rate (in kilo-symbols/sec), and code rate
Power	The instantaneous transmit power in dBm that the modem is using at the moment
Initial Power	The transmit power in dBm that the modem uses when starting the network login process
Max Power	The maximum power in dBm that the modem will use (calculated and stored in the modem when the P1dB test is performed)

Position Backup Source

Message	Description
State	State of the backup GPS: <ul style="list-style-type: none"> • ACQUIRED – Connected, has a valid fix • ACQUIRING – Connected, does not have a valid fix • NOT CONNECTED
Latitude/ Longitude	Latitude and longitude reported by the backup GPS, if connected with a valid fix

Status Information on the ICM Front Panel LCD

On the front panel of the ICM, you can view much of the same status information that's available on the web interface.

To view the status information, follow these steps:

1. Press **MENUS** on the ICM's front panel to bring up the Status menu.
2. Press **ACCEPT** to access the status menu. Then use the **MENUS** and **ACCEPT** buttons to scroll through the submenus.

Figure 9-4 Status Menu on ICM Front Panel

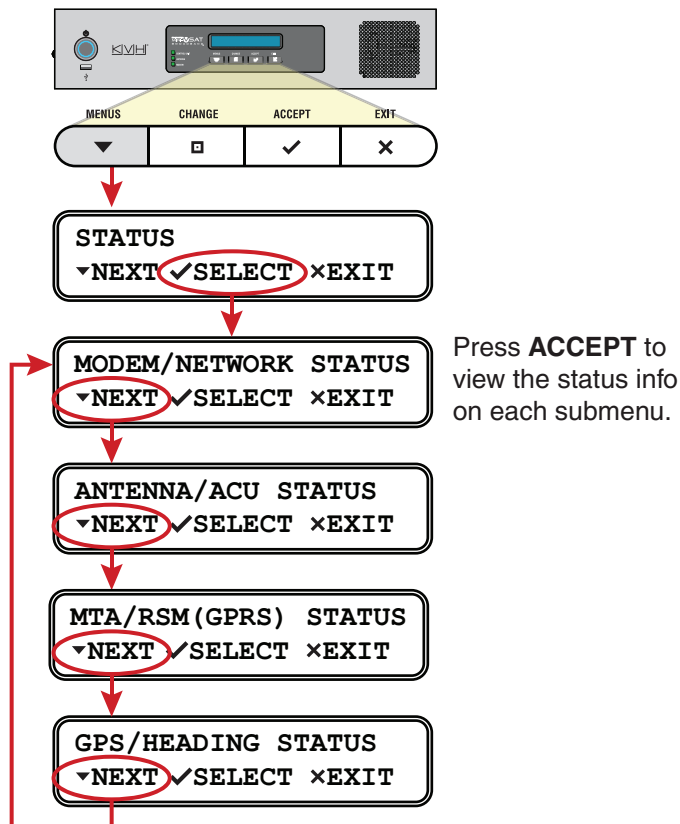

Modem/Network Status

Message	Description
MODEM MANAGEMENT IP	The external IP address of the system on the mini-VSAT Broadband network.
MODEM STATE	General status of the modem; "In Network" indicates the modem is logged into the mini-VSAT Broadband service (see "General Statistics" on page 130)
LAN PORT STATUS	Status of the Ethernet local area network (LAN); "LINK" indicates a good connection
SNR	Quality of the received satellite signal; SNR = Signal level/background noise in decibels
SATELLITE	Satellite currently selected for mini-VSAT Broadband service
BEAM	Beam frequency in GHz of the satellite currently selected for mini-VSAT Broadband service
DOWNLINK FREQUENCY	Frequency of the satellite downlink
SKEW TO SATELLITE	Skew angle of the antenna's LNB that is required to receive signals from the current satellite

Antenna/ACU Status

Message	Description
ANTENNA STATE	General status of the antenna; must be "Tracking" to connect to mini-VSAT Broadband
ANTENNA DC INPUT	DC voltage measured at the antenna's circuit board; should be between 38 VDC and 44 VDC
CURRENT AZ/EL	Azimuth and elevation at which the antenna is currently pointing; azimuth is relative to vessel heading if heading data is available, or the antenna's "Forward" arrow (bow) if heading data is not available
CURRENT SKEW	Current skew angle of the antenna's LNB
IPACU DC INPUT	DC voltage measured at the ICM's power input; should be between 23 VDC and 25 VDC
IPACU ENET MODEM PORT STATE	Status of the ICM's Ethernet connection to its built-in modem; "Link" indicates the jumper cable is connected between B1 and B2 on the ICM's rear panel

MTA/RSM(GPRS) Status

Message	Description
MTA STATUS	Status of the ICM's built-in MTA; "Registered" indicates the MTA is connected to the voice service
RSM (GPRS) STATUS	Status of the antenna's built-in remote service and support module (GPRS modem); "Registered" indicates a good GPRS cellular connection



GPS/Heading Status

Message	Description
CURRENT GPS SOURCE	Source of the GPS data used by the system
SYSTEM GPS STATUS	Status of the GPS currently being used by the antenna; displays vessel latitude/longitude if GPS has a valid fix
NMEA TRUE HEADING	True heading reported by the vessel's NMEA 0183 talker; "No Compass Input" indicates the system is not receiving a compatible heading message from a NMEA 0183 talker

LED Indicators

Status lights on the front of the ICM indicate the current status of the system and can help you identify problems quickly.

Figure 9-5 Status Lights

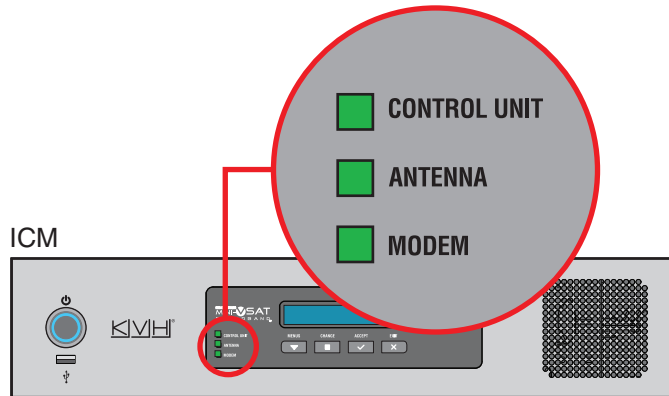

During normal operation, all status lights should be lit green. The following tables explain what the different light conditions indicate.

CONTROL UNIT Light

The table below explains what the CONTROL UNIT light indicates.

Light is...	Indicates	Description
Off	Off	ICM is powered off or no power input
Green	OK	Good input power; ICM is operational
Green, flashing	Initializing	System is starting up
Orange	Warning	Check front panel LCD or web interface for warning message (see “Error and Warning Messages” on page 121 for details)
Red	Error	Check front panel LCD or web interface for error message (see “Error and Warning Messages” on page 121 for details)

ANTENNA Light

The table below explains what the ANTENNA light indicates.

Light is...	Indicates	Description
Off	Off	No power input to the antenna
Green	Tracking	Antenna is tracking a satellite
Green, flashing	Searching	Antenna is searching for a satellite, waiting for modem communications, or processing a software update
Orange	Warning	Check front panel LCD or web interface for warning message (see “Error and Warning Messages” on page 121 for details)
Red	Error	Check front panel LCD or web interface for error message (see “Error and Warning Messages” on page 121 for details)

MODEM Light

The table below explains what the MODEM light indicates.

Light is...	Indicates	Description
Off	Off	The ICM's built-in modem is powered off
Green	Online	Modem is logged into the mini-VSAT Broadband service
Green, flashing	Initializing	Modem is communicating with the antenna, but it is not yet online
Orange	Offline	Modem has logged out of the mini-VSAT Broadband service
Red	No comms	ICM lost communications with its built-in modem; check cable on ICM rear panel
Red, flashing	No internal comms	Modem is not communicating with the ICM, but wiring is OK

System Logs

The ICM offers two logs to capture historical antenna system data:

- Operational Log (see “Operational Log”)
- Event Log (see “Event Log” on page 139)

These logs are excellent diagnostic tools, so a technician or KVH Technical Support may refer to them when troubleshooting a system problem.

Operational Log

The Operational Log, when initiated, records all messages that the antenna system generates.

To start a new log or view the current log, follow these steps:

1. At the TracPhone V7-HTS web interface, click the **Support** tab.
2. On the **System Logs** menu, click **Operational Log**.

Figure 9-6 Viewing the Operational Log

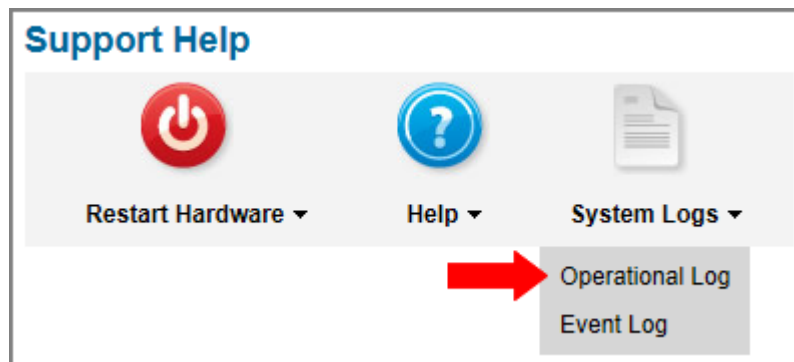

3. Click the button for your desired option:

- **View/Save Operational Log:** This option simply opens the current Operational Log. You can save this log as a text file to send to a technician or KVH Technical Support.
- **Start New Log:** This option deletes the current Operational Log and begins recording a new one.

- **Restart System, Start New Log:** This option deletes the current Operational Log, restarts the antenna, and begins recording a new Operational Log. This log will begin with the system's startup messages, which include the results of various self-test routines.

Figure 9-7 Operational Log Options

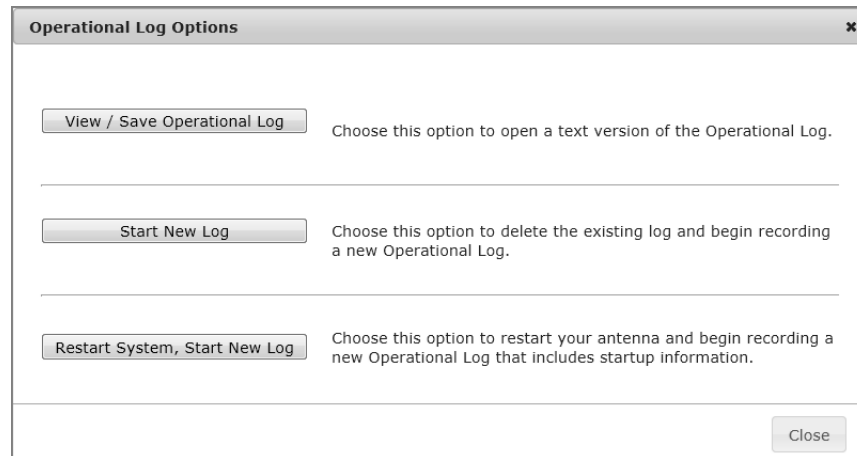

Event Log

The Event Log keeps a historical record of the error and warning messages the antenna system generates. The most recent entries in this log are displayed on the Support page of the TracPhone V7-HTS web interface.

To view the complete Event Log, follow these steps:

1. At the TracPhone V7-HTS web interface, click the **Support** tab.
2. On the **System Logs** menu, click **Event Log**.

Figure 9-8 Viewing the Event Log

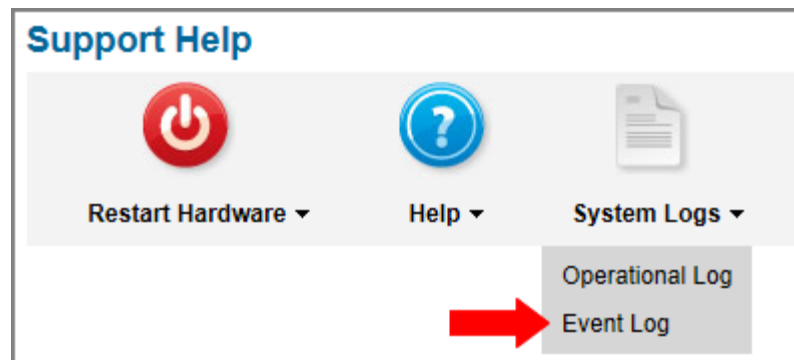

Equipment ID Numbers

On the Support page of the TracPhone V7-HTS web interface, you can find the following important equipment identification numbers:

- Antenna serial number
- ICM serial number
- Modem serial number
- Modem Device ID number
- MTA MAC address

NOTE: The modem and MTA are built into the ICM.

Figure 9-9 Viewing Equipment Identification Numbers

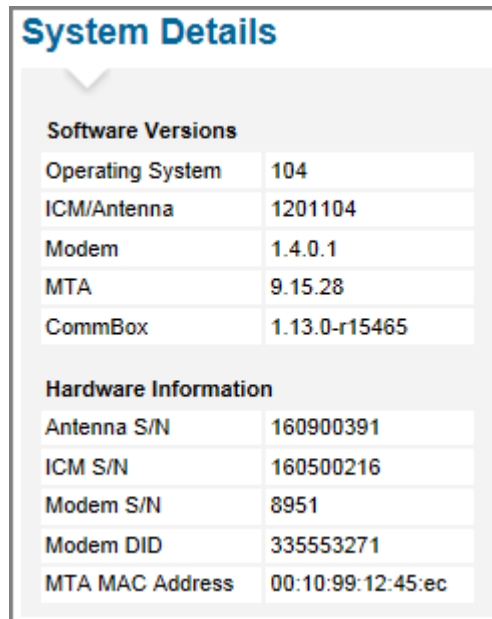

The screenshot shows a 'System Details' page with two sections: 'Software Versions' and 'Hardware Information'. Each section contains a table of key-value pairs.

Software Versions	
Operating System	104
ICM/Antenna	1201104
Modem	1.4.0.1
MTA	9.15.28
CommBox	1.13.0-r15465

Hardware Information	
Antenna S/N	160900391
ICM S/N	160500216
Modem S/N	8951
Modem DID	335553271
MTA MAC Address	00:10:99:12:45:ec

NOTE: You can also view these equipment ID numbers on the front panel LCD (go to System Info > Hardware Information).

You will need the antenna and ICM serial numbers when activating the system and whenever you contact KVH Technical Support. You will also need the modem's IP address, which is displayed on the Support page under General Statistics (see ["Support Page of the Web Interface"](#) on page 129).

Software Versions

On the Support page of the TracPhone V7-HTS web interface, you can view the currently installed versions of the following software:

- Operating system (resides on ICM)
- ICM/Antenna – *you can update this software through the ICM (see “Software Updates” on page 149)*
- Modem
- MTA
- CommBox

Figure 9-10 Viewing the Software Versions

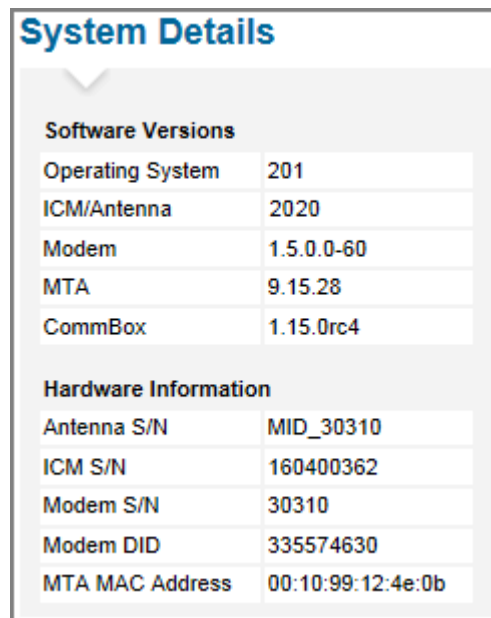

The screenshot shows a web interface titled "System Details" with a dropdown arrow. It contains two sections: "Software Versions" and "Hardware Information".

Software Versions	
Operating System	201
ICM/Antenna	2020
Modem	1.5.0.0-60
MTA	9.15.28
CommBox	1.15.0rc4

Hardware Information	
Antenna S/N	MID_30310
ICM S/N	160400362
Modem S/N	30310
Modem DID	335574630
MTA MAC Address	00:10:99:12:4e:0b

NOTE: You can also view these software versions on the ICM's front panel LCD (go to System Info > Software Versions).

OneCare Customer Support

KVH provides comprehensive, full life-cycle support for mini-VSAT Broadband customers as defined by the following phases:

Application Engineering

- Sales and/or engineering assistance for solution design to address vessel or fleet operating needs

Solution Deployment

- Installation planning, vessel preparation, service commissioning, system test, and training

Ongoing Operating Support

- Technical assistance for service fault management and the fastest possible response should there be a problem
- Preventative maintenance for high system availability
- Extended warranties for operating cost certainty

OneCare offers coverage of KVH's complete sales portfolio, including the following:

- **KVH-manufactured products:** mini-VSAT Broadband systems
- **KVH-delivered services:** Airtime and other over-the-top services such as voice-over-IP (VoIP)
- **KVH-integrated solutions:** mini-VSAT Broadband system plus other KVH and/or other third-party equipment and services provided by KVH
- **KVH-managed land-side IT infrastructure:** Supporting software applications provided by KVH

To learn more about the OneCare services that are available to you, contact KVH Technical Support or visit www.kvh.com/onecare. At KVH, we want customers to use and enjoy their service while KVH manages all the required technical and operational details.



Contacting KVH Technical Support

If you experience an operating problem or require technical assistance, please contact KVH Technical Support (24x7/365):

Within the Continental U.S.A.:

Phone: 1 866 701-7103

Email: mvbsupport@kvh.com

North/South America, Australasia:

Phone: +1 401 851-3806

Email: mvbsupport@kvh.com

Europe, Middle East, Asia-Pacific, Africa:

Phone: +45 45 160 180

Email: mvbsupport@kvh.com

Please have your system serial numbers and software versions handy before you call (see [“Equipment ID Numbers”](#) on page 140 and [“Software Versions”](#) on page 141).

Remote Diagnostics

If your vessel is located within a GPRS cellular coverage area, KVH Technical Support may be able to “dial in” to your TracPhone system through the antenna’s remote service and support module (RSM). With direct access to your system’s built-in diagnostic tools, KVH can often find the problem quickly to get you back up and running.

NOTE: Standard airtime rates will apply.

NOTE: You can view the IP address used for remote diagnostics on the front panel LCD (go to Diagnostic Tools > KVH Support IP)

Figure 9-11 Remote Diagnostics

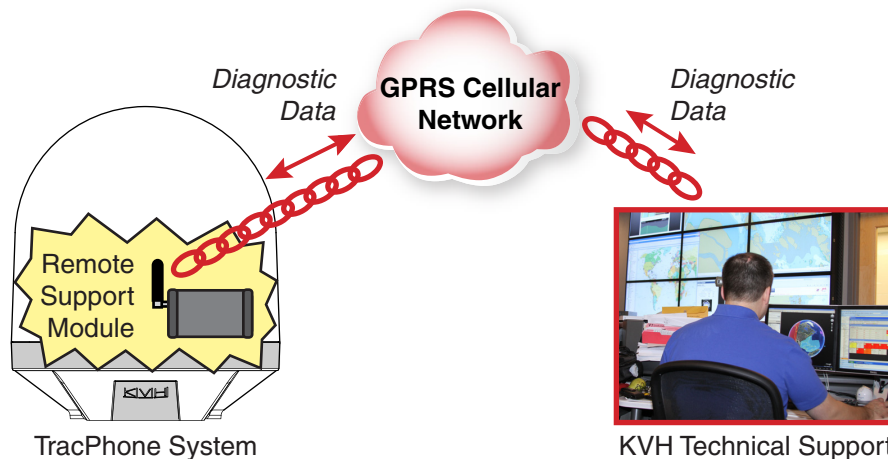

The Support page of the TracPhone V7-HTS web interface indicates when a KVH technician is connected to the system. Do not modify any system settings during this diagnostics session.

Figure 9-12 Remote Help Status Message

Remote Help Controls

Connected! Active Remote Help Session in Progress

A KVH Technical Support technician is now connected to your system. Unless directed, Please **DO NOT** modify settings while this session is active. You will be notified when the session ends.

Note: Standard airtime rates apply

10. Maintenance

This section explains how to perform preventative maintenance to keep the system in tip-top shape. It also explains how to update the software and restart system components.

Contents

Preventative Maintenance	147
Software Updates	149
Corrective Maintenance.....	154
Hardware Restart	155



Preventative Maintenance

Your TracPhone system is likely subjected to heavy use and exposed to harsh marine environmental conditions. Therefore, like any sophisticated electronic equipment installed on the vessel, it needs to be cleaned, inspected, and updated on a regular basis to maintain its peak performance and reliable service.

Routine Care

KVH recommends that you perform the following tasks periodically to help keep the system running smoothly.

- Vacuum the vents on the ICM. Air needs to flow through these vents to cool the electronic components and prevent overheating.

Figure 10-1 Vents on ICM and Modem

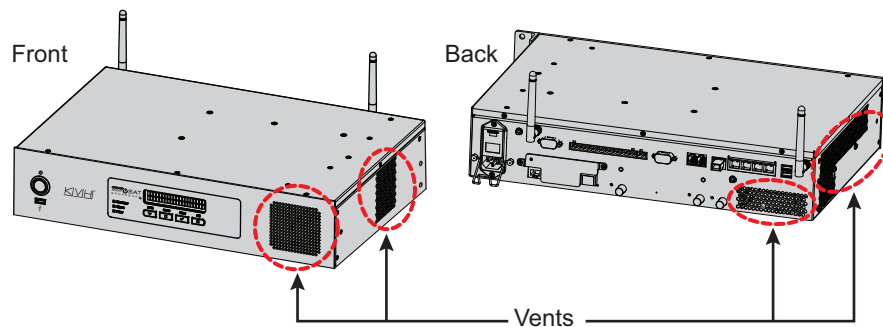

- Clean the outside of the antenna with fresh water to remove grime. Dirt buildup can affect communications. You may use mild detergent, but avoid abrasive cleansers and high-pressure water.
- Inspect cable connections at the ICM for any wear and tear. Repair any damaged cables.
- Ensure the latest software version is installed. Refer to [“Software Updates” on page 149](#) for details.

Annual Preventative Maintenance Check

In addition to the routine care that you do yourself, KVH recommends that you have your antenna system checked by a KVH-certified technician on an annual basis. During this service call, the technician will conduct a thorough inspection of the entire system. Some of the items on the preventative maintenance checklist include:

- Measure the input voltage and verify the system is properly grounded
- Verify that the antenna is securely and safely mounted and meets all installation best practices
- Check cables, both inside and outside the dome, for loose connections, frayed wires, corroded connectors, kinks, or other damage
- Inspect the internal antenna mechanism inside the dome, looking for any signs of wear and tear or potential points of failure
- Check all motors, belts, and limit switches and verify antenna has full range of motion
- Update the system software to the currently released version, ensuring the system has all of the latest features and enhancements
- Test the system for proper operation and capture antenna diagnostics information

To schedule a preventative maintenance check, contact KVH Technical Support (see [“Contacting KVH Technical Support”](#) on page 143).

NOTE: If you are subscribed to a KVH OneCare Technical Assistance Package, KVH will contact you every year when it is nearing the time for your next annual preventative maintenance check. At your option, you can then schedule the check at a convenient time for your vessel.

Software Updates

KVH periodically releases new versions of software to enhance the performance and capabilities of the system. You can update your system to this latest software at any time by downloading the file from KVH's Update server and uploading it to the ICM. When you update the software, the new version simply overwrites the previously installed version.

A single software package includes updates to all system components in the antenna and ICM, with the exception of the modem. Modem updates are downloaded automatically via the satellite connection. When a modem update is in progress, the TracPhone V7-HTS web interface shows "Updating" under Connection Status, and the ICM front panel display shows "Do not power down - Updating" for up to 30 minutes.

Important!

To upgrade to version 3010 or later from a version earlier than 3000, your system must first be upgraded to version 3000. Version 3000 was the last version to have a ".kvh" file extension, and it was the first version to recognize the new ".bin" extension used by all future software update packages, which incorporate new encryption technology for enhanced system security.

There are several methods to choose from to update the software:

- ["Using the ICM to Update Software" on page 150](#)
- ["Using Your Computer to Update Software" on page 151](#)
- ["Using an iPhone/iPod touch to Update Software" on page 152](#)
- ["Using a USB Flash Drive to Update Software" on page 153](#)

Using the ICM to Update Software

NOTE: This method requires Internet access; airtime charges may apply.

To update the software using the ICM and your mini-VSAT Broadband connection, follow these steps:

1. At the TracPhone V7-HTS web interface, click the **Updates** tab.
2. Under Software Update Status, click **Check Now**.
3. If the ICM is able to connect to KVH's Updates server, it notifies you whether a new version is available for download. If there is, click **Download and Install** to download the update file and install it in your system.

Figure 10-2 Updating Software Using the ICM

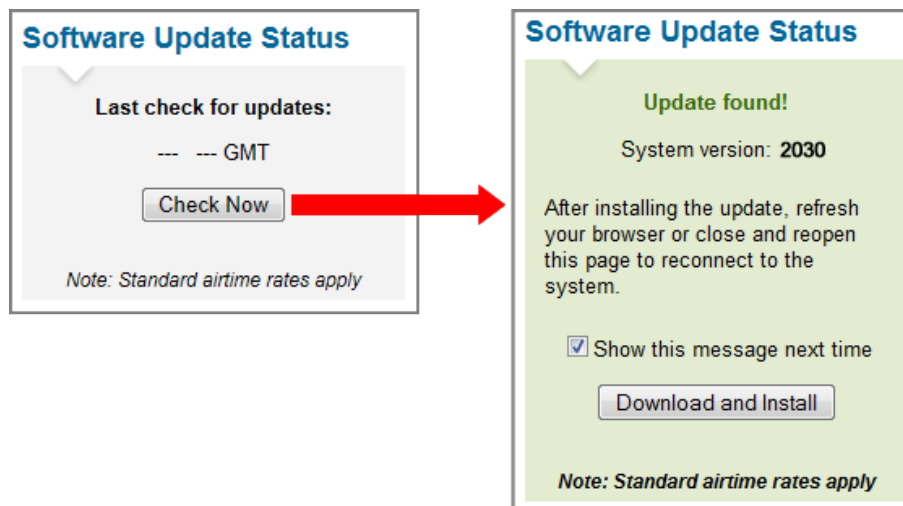

Using Your Computer to Update Software

To update the software using your local computer, follow these steps:

1. First, you need to save the latest software update file to your computer. KVH-certified technicians can download this file from the KVH Partner Portal. Customers can get this file from KVH Technical Support (see [“Contacting KVH Technical Support”](#) on page 143).
2. Connect your computer to the ICM's network.
3. At the TracPhone V7-HTS web interface, click the **Updates** tab.
4. If a Choose File button appears under Update Using this Computer, click **Choose File** then log in with the Administrator password.
5. Under Update Using this Computer, click **Browse**.
6. Navigate to and select the update file saved on your computer.
7. Click **Check File**.
8. At the confirmation message, click **Update**.

Figure 10-3 Updating Software Using Your Computer (Example)

Update Using this Computer

To update the system's software using a file located on this computer, click **Browse** to locate the file. Then click **Check File**.

Software Update File:

Model-Version.bin [Remove File](#)

Using an iPhone/iPod touch to Update Software

To update the software using an iPhone/iPod touch, follow these steps:

1. If you haven't already done so, download the mini-VSAT app from the Apple App Store.
2. Use the iPhone/iPod touch app to download the latest software version to your iPhone/iPod touch at any time.
3. Make sure the TracPhone system is turned on and initialized (the ICM front panel LCD shows "Searching" or "Tracking").
4. Connect your iPhone/iPod touch to the TracPhone system via its wireless connection, then use the app to install the software.

Figure 10-4 Updating Software Using the iPhone/iPod touch App



Using a USB Flash Drive to Update Software

To update the software using a USB flash drive, follow these steps:

1. First, you need to save the latest software update file to the root directory of your USB flash drive. KVH-certified technicians can download this file from the KVH Partner Portal. Customers can get this file from KVH Technical Support (see [“Contacting KVH Technical Support”](#) on page 143).
2. Make sure the TracPhone system is turned on and initialized (the ICM front panel LCD shows “Searching” or “Tracking”).
3. Connect your USB flash drive to the USB port on the front of the ICM.
4. The ICM display shows the currently installed software version (“CUR”) and the software version found on the USB flash drive (“NEW”). Make sure the “NEW” version is a higher number than the “CUR” version.
5. At “PROCEED WITH UPDATE?,” press **ACCEPT**.

Figure 10-5 Software Update Process on ICM Front Panel

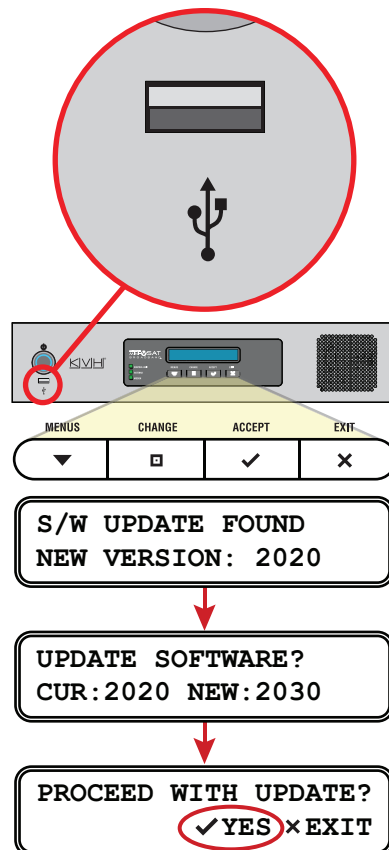

Corrective Maintenance

If a system component fails, it will need to be replaced by a KVH-certified technician. The system is a sophisticated electronic device; only specially trained KVH-certified technicians have the tools and expertise necessary to diagnose and repair a system fault.

Important!

Field replaceable units should only be replaced by a trained, KVH-certified technician. To find a technician near you, visit www.kvh.com/wheretogetservice or contact KVH Technical Support (see “Contacting KVH Technical Support” on page 143). Instructions are provided with the replacement part.

Hardware Restart

If you experience a problem with the system, you may need to restart the hardware. You can restart the following system components from the TracPhone V7-HTS web interface:

- **Restart Antenna** – Restarts the TracPhone V7-HTS antenna. Choose this option whenever the antenna is unable to find the satellite.
- **Restart MTA** – Restarts the MTA (multimedia terminal adapter), which is built into the ICM. Choose this option whenever voice calls are not working properly while the system is online.
- **Restart All** – Restarts the entire system. Choose this option if the problem cannot be isolated to an antenna or MTA issue.

To restart a system component, follow these steps:

1. At the TracPhone V7-HTS web interface, click the **Support** tab.
2. On the **Restart Hardware** menu, click the desired option.

Figure 10-6 Restart Hardware Menu

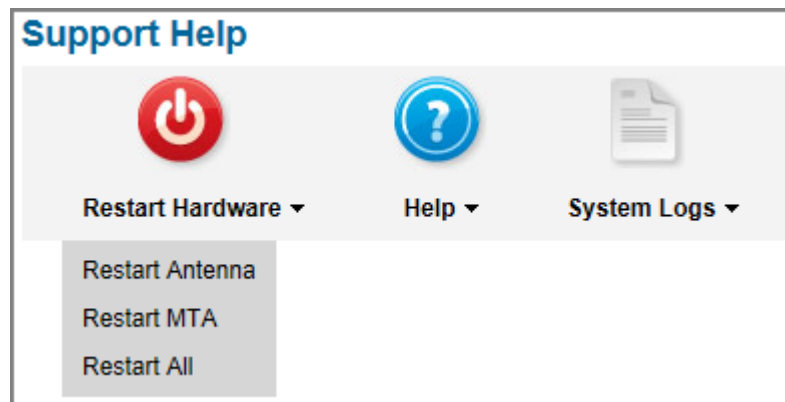

3. At the confirmation message, click **Restart Antenna**, **Restart MTA**, or **Restart ALL**.



Appendix

A. Wiring Diagram

This section provides a system wiring diagram. For detailed installation instructions, refer to the Installation Guide.

Contents

Wiring Diagram..... 159



Wiring Diagram

The wiring diagram below shows the basic system connections. For detailed installation instructions, refer to the Installation Guide.

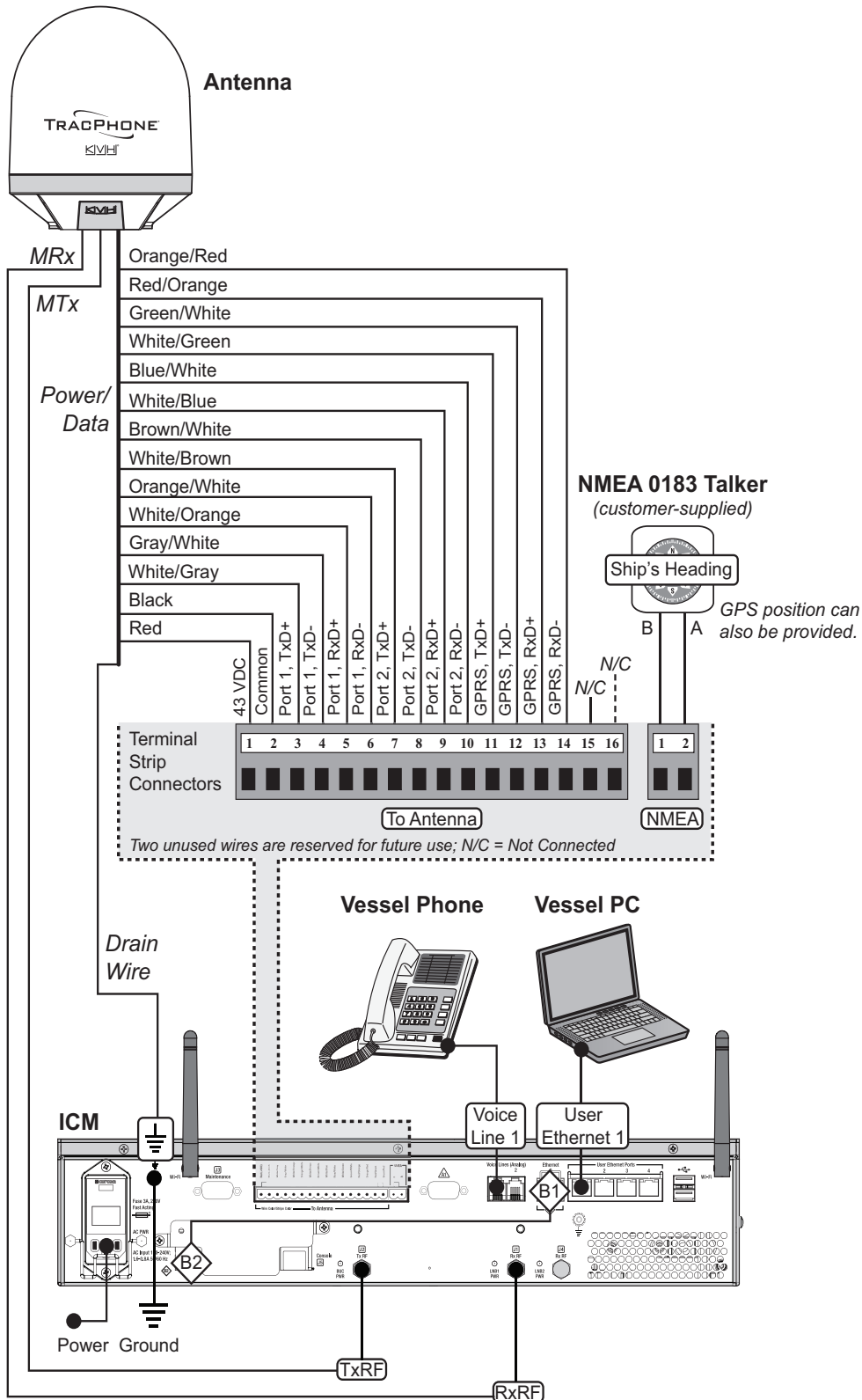



Appendix

B. LCD Menus

This section provides a quick reference guide to the LCD menus on the ICM's front panel.

Contents

LCD Menu Quick Reference Guide 163



LCD Menu Quick Reference Guide

The chart below shows the menu structure of the ICM front panel LCD interface.

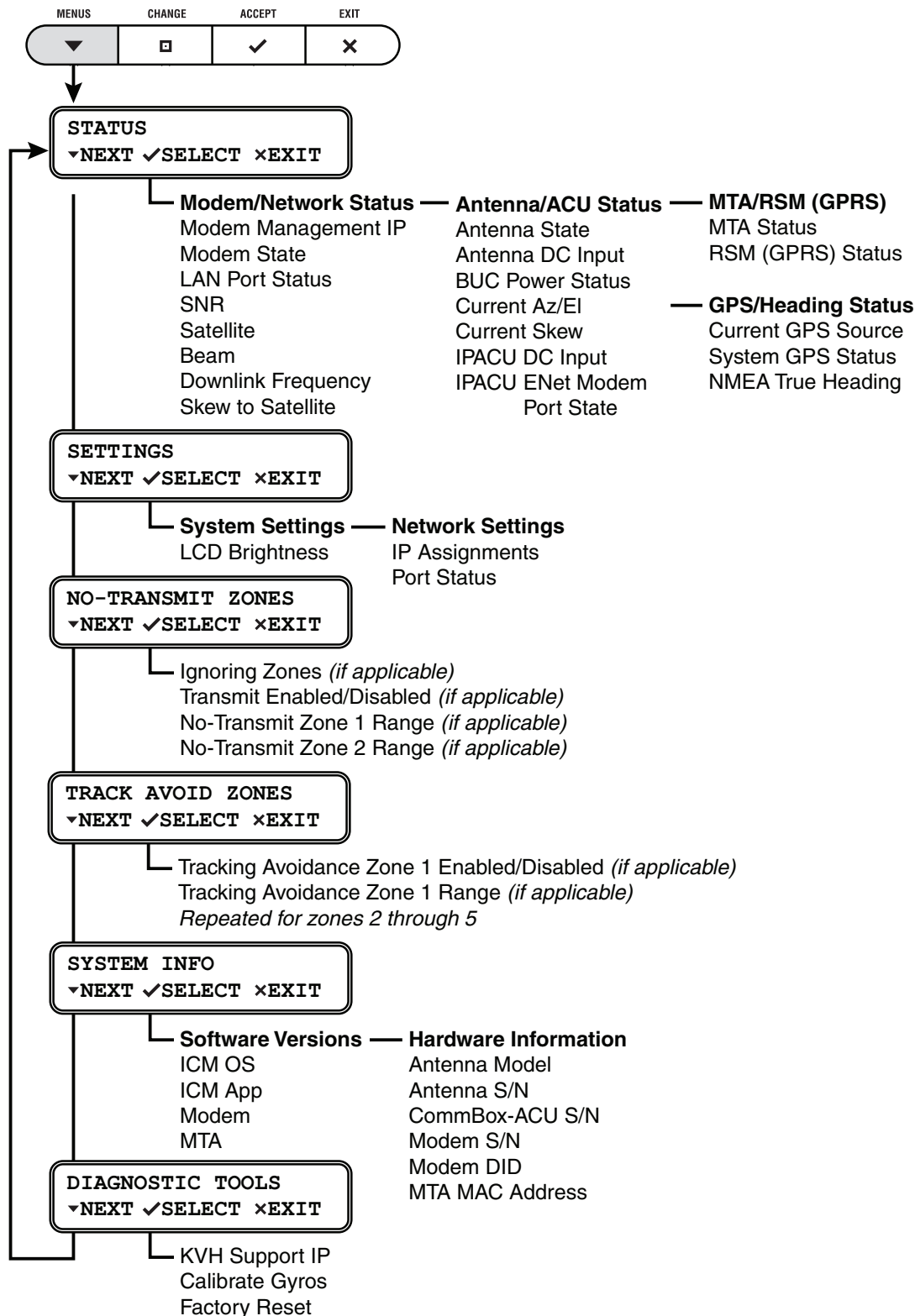



Appendix

C. Specifications

This section provides the technical specifications of the TracPhone system's components.

Contents

System Specifications	167
-----------------------------	-----

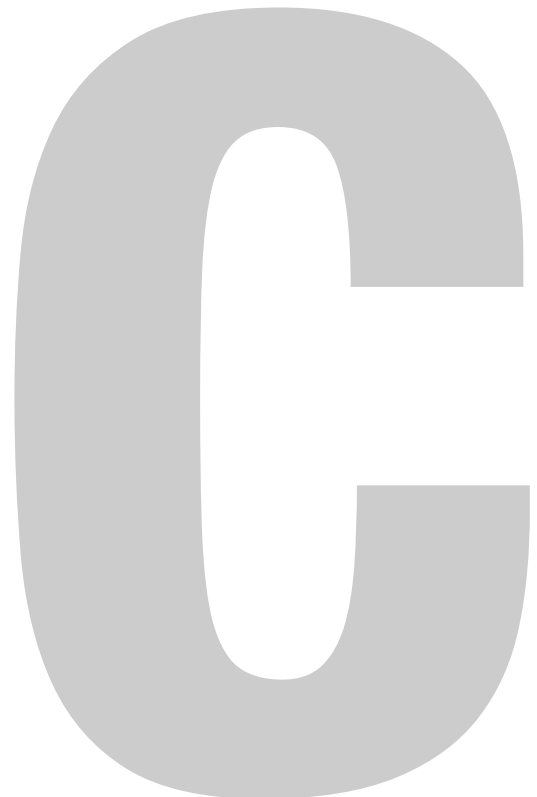

System Specifications

Antenna Specifications

Attribute	Rating
Meets Inmarsat operational, survival, and shock specifications	
RX receive/TX transmit frequency band	10.95-12.75 GHz/14.0-14.5 GHz
Antenna gain	35.6 dBi (RX-band, min)
Transmit power (BUC)	4 W max
Elevation range	-24° to +119° (<i>with heading input</i>)
Azimuth range	710° rotation
Satellite coverage	See www.kvh.com/minivsatmap
Temperature	Operational: -22° F to +131° F (-30° C to +55° C) Survival: -22° F to +158° F (-30° C to +70° C)
Humidity	IEC 60945; 104° F (40° C), 95% humidity (non-condensing)
Rain	100-knot wind with 1.7 mm/min (4"/hr) rain, with droplet size between 0.5 and 4.5 mm
Outside dimensions	26.2" (66.6 cm) OD x 31.2" (79.2 cm) H
Weight	57.6 lbs (26.1 kg)

* Specifications are subject to change without notice.

ICM Specifications

Attribute	Rating
NMEA input	NMEA 0183, 4800 baud, accurate within 2°, compatible sentences: <i>Heading</i> : \$--HDG, \$--HDM, \$--HDT, \$--OSD, \$--THS, \$--VHW, <i>GPS</i> : \$--RMC
Input voltage	100-240 VAC, 50-60 Hz
Temperature	Operational: 5° F to 131° F (-15° C to +55° C) Survival: 5° F to 158° F (-15° C to +70° C)
Humidity	IEC 60945; 104° F (40° C), 95% humidity (non-condensing)
Interfaces	User Ethernet: RJ45, IEEE 802.3, 10BASE-T/100BASE-TX, 100 Mbps Wireless access point: 802.11b, 802.11g, 802.11n USB (Front Panel): USB 2.0 (for software updates only) USB (Rear Panel): Not Used Voice lines: RJ11 (2-wire) analog
Dimensions	16.75" (42.55 cm) W x 11.17" (28.37 cm) D without strain-relief bracket, 16.31" (41.43 cm) D with strain-relief bracket x 3.49" (8.85 cm) H (2U)
Weight	10.71 lbs (4.85 kg)

* Specifications are subject to change without notice.



Appendix

D. Glossary

This section provides a glossary of technical terms used throughout the documentation.

Contents

Glossary.....	171
---------------	-----



Glossary

10BaseT

Ethernet standard using twisted pair cabling (such as CAT5). Supports a maximum data rate of 10 Mbps.

100BaseT

Fast Ethernet standard using twisted pair cabling (such as CAT5). Supports a maximum data rate of 100 Mbps.

802.11

Wireless network communications standard commonly used in LANs.

ACU

Antenna Control Unit.

AGC

Automatic Gain Control. Function that automatically boosts the gain of a received signal, as required, to maintain a constant output level. Indicates RF level.

Analog Phone

Standard telephone, also referred to as POTS (Plain Old Telephone Service). Voice signals are converted into electrical pulses by modulating a carrier signal.

AZ

Azimuth angle. Horizontal direction in which the antenna points.

bps

Bits per second.

BUC

Block Up-Converter. Device that converts the intermediate frequency signal from the modem to a Ku-band frequency and amplifies it for transmission.

Bulletin Board

Communications from the hub to all terminals within its network.

Cache

A web browser's local storage of visited web pages and other Internet files, allowing that information to be accessed more quickly on subsequent visits.

CAT5

Category of twisted pair cable with a maximum data rate of 1,000 Mbps.

Channel

Frequency (between 2.4-2.5 GHz) used for Wi-Fi communications. To communicate via a wireless connection, both router and host must be set to the same channel. There are 11 channels to choose from, allowing users to prevent interference between multiple wireless networks.

Chassis

The outside enclosure of an electronic device.

Client

A computer application that accesses resources held by a server.

Cloud

"The cloud" refers to the accessibility of software applications and data storage services through a web browser.

Crossover Cable

Cable in which the pins are reversed from one end to the other. Used for connecting two computers back-to-back without using an Ethernet hub.

Data Rate

Speed at which a communications path can transfer information, normally measured in bits per second (bps).

dB

Decibel. Ratio of one power level to another.

DHCP

Dynamic Host Configuration Protocol. IP protocol that allows a server to automatically assign IP addressing information to a computer or device on the network.

DNS

Domain Name Service. IP service that translates domain names (such as "www.kvh.com") into IP addresses (such as "63.105.58.10").

Downlink

Communication path from the satellite to the antenna.

DVB

Digital Video Broadcasting project. Global standard of digital broadcasts.

EIRP

Effective Isotropic Radiated Power, measured in dBW.

EL

Elevation angle. Vertical direction in which the antenna points.

Encryption

As it applies to Wi-Fi, encoding of a wireless signal to protect it from unauthorized reception.

Ethernet

Network communications standard adopted by most LANs. Communicates via twisted pair cable at one of three maximum data rates: (1) Standard - 10 Mbps, (2) Fast - 100 Mbps, and (3) Gigabit - 1 Gbps (1,000 Mbps).

Firewall

Security mechanism that protects a network from unauthorized access.

Floating Ground

Dangerous condition in which the chassis ground of an electrical device differs from ship's ground. This difference can measure well over 100 volts, risking damage to the equipment and electric shock, potentially resulting in death. A floating ground can be prevented by ensuring proper grounding of the device to ship's ground.

Footprint

Coverage area of a satellite.

Forward Link

Communication path from the satellite hub to the user terminal.
Another term for "Downlink."

Frequency

Number of cycles per second of a radio wave, measured in Hertz (Hz).

GPRS

General Packet Radio Service. High-speed wireless data communications standard.

GPS

Global Positioning System. Network of satellites that allow anyone with a GPS device to accurately fix their position on Earth.

Gyro

A device that precisely senses and measures motion in a single axis, such as elevation or azimuth.

Host

Any computer connected to a network.

HTS

High-throughput Satellite Network. The satellite network is comprised of spot beams (for high capacity, fast speeds, and enhanced reception) and wide beams (for continued service when outside spot beam coverage).

HTTP

HyperText Transfer Protocol. The primary protocol for the World Wide Web.

Hub

Earth station that links the satellite network to the terrestrial network.

ICM

Integrated CommBox Modem.

IF

Intermediate Frequency. As it applies to TracPhone V7-HTS, L-band output of an LNB, or input to a BUC.

IMAP

Internet Message Access Protocol. Email protocol by which a client retrieves user-selected messages that are stored on a remote mail server. Messages are saved on the server until the user deletes them.

Internet

Global network connecting a vast number of networks and computers.

IP Address

Unique network identifier assigned to a single computer or device on a network. Consists of four eight-bit numbers, each between 0 and 255 (for example, "195.172.7.2").

Kbps

Kilobits (1,000 bits) per second.

Ku-band

Range of frequencies from 10.7 GHz to 18 GHz.

LAN

Local Area Network. A relatively small group of computers and devices linked together within close proximity to each other and usually on the same IP network.

L-band

Range of frequencies from 950 MHz to 2150 MHz.

LNB

Low Noise Block down-converter. Device that converts and amplifies a Ku-band satellite signal into an intermediate frequency (IF) L-band signal.

MAC Address

Media Access Control Address. Unique six-byte hardware identifier assigned to every network interface card (NIC). Used in most LAN configurations to ensure the correct addressing of data to specific hosts.

Mbps

Megabits (1,000,000 bits) per second.

Modem

Modulator-demodulator. Translates digital signals into analog signals and vice-versa.

MTA

Multimedia Terminal Adapter. Device that converts analog telephone signals into digital Voice over IP (VoIP) signals.

Network

A group of computers and devices (such as printers) linked together.

Network Operations Center (NOC)

Station that maintains and manages a telecommunications network.

NIC

Network Interface Card. Expansion or built-in circuit card that provides a computer with network communication capabilities.

NMEA 0183 Talker

Marine electronic device, such as a gyrocompass, that transmits data messages that comply with the NMEA 0183 standard. Data is transmitted serially at 4800 baud over a pair of wires (A and B).

Orbital Slot

The longitude of the satellite that the modem has currently selected for tracking.

Packet

Part of a data message transmitted over a network. Also contains the address of the destination for routing purposes. (Data messages are divided into packets, sent over a network, then reassembled in the correct order at the destination.)

PCI

Peripheral Component Interconnect. Bus standard that supports high-speed connections between computers and peripheral devices.

PCMCIA

Personal Computer Memory Card International Association. Organization that establishes standards for PC cards, credit card-sized memory or input/output devices, primarily used in laptops.

Ping

Software utility used to check a network connection. Sends a test packet to the designated address and reports how long it takes to receive a response.

Polarization

Orientation of a satellite signal. Circular polarization, which has a "corkscrew" propagation path, consists of left-hand (LHCP) and right-hand (RHCP) signals. Linear polarization consists of vertical and horizontal signals offset by 90 degrees.

POP3

Post Office Protocol. Email protocol by which a client retrieves all available messages from a remote mail server and saves them locally. Messages are normally deleted from the server upon download.

Protocol

Standard that establishes strict rules for how data is communicated over a network.

Proxy

A server that controls client access to another server.

PSTN

Public Switched Telephone Network. Worldwide telephone network carrying analog voice signals.

Return Link

Communication path from the antenna to the satellite. Another term for "Uplink."

RF

Radio Frequency.

RJ45

Registered Jack 45. Eight-wire network cable connector for LANs. Similar to a telephone jack.

Router

Device that connects multiple IP networks. For each data packet it receives that is destined for another IP network, determines the best path to reach its destination.

RSSI

Receive Signal Strength Indicator. Indicates the strength of the received satellite signal.

RX

Receive.

SIP

Session Initiation Protocol. Protocol for routing VoIP calls.

Skew

Adjustment angle to orient an LNB with a linearly polarized satellite signal.

SNR

Ratio of signal-level to background-noise in decibels, indicating the general quality of a received signal.

SSID

Service Set Identifier. Unique identifier shared by all computers and devices on a single wireless network.

Straight-through Cable

Cable in which the pins at one end match the pins at the other end.

Subnet

Subdivision of a network based on IP address. For example, with a subnet mask of "255.255.255.0," all computers and devices assigned an IP address starting with "195.172.8" belong to one subnet (there are 255 possible). An IP address starting with "195.172.9" designates a different subnet.

Subnet Mask

Divides the latter portion of an IP address into subnet and host designations. For example, in a regular class B network, the first two numbers in an IP address define the network ID while the last two numbers define the host ID (the individual computer or device on that network). A subnet mask changes the format of these last two numbers by designating the third number as the subnet ID and designating the last number as the host ID (the computer or device within that subnet).

SW

Software.

Switch

Device that connects two segments of a LAN. Routes data from one segment to another based on the MAC address of the destination.

TCP/IP

Transmission Control Protocol/Internet Protocol. Two communications protocols for the Internet. IP handles the delivery of data packets over the Internet; TCP ensures that all data packets are successfully delivered and assembled in the proper order.

Transponder

Component of a satellite that receives radio transmissions from Earth, amplifies them, and retransmits them back to Earth on a different frequency.

Twisted Pair

Cable type consisting of multiple pairs of cable in which two wires are spiraled together to reduce electromagnetic noise. Can be either shielded (STP) or unshielded (UTP). Used extensively in LANs and telephone networks.

TX

Transmit.

URL

Uniform Resource Locator. Address of a web page or file on the World Wide Web. Consists of three parts: (1) protocol (such as "http"), (2) IP address or domain name (such as "www.kvh.com"), and (3) name of the web page or file to be retrieved from that address (such as "index.html").

USB

Universal Serial Bus. Bus standard for connecting peripheral devices to a computer. Supports a data rate of 12 Mbps.

UTP

Unshielded Twisted Pair. Cable consisting of four twisted pairs (8 wires), usually terminated by RJ45 connectors. Commonly used in LANs.

VoIP

Voice over Internet Protocol. Allows telephone conversations to be routed via the Internet.

VSAT

Very Small Aperture (< 3 m) Terminal. Communications system in which multiple users connect via satellite to a single land-based hub, which handles the routing of all network traffic.

WAN

Wide Area Network. A group of computers, devices, and possibly LANs, linked together over a large geographic area.

WAP

Wireless Access Point. Device that links computers wirelessly to a LAN. To communicate with the WAP, each computer needs a properly configured wireless network card.

WEP

Wired Equivalent Privacy. Security mechanism for wireless networks. Encrypts data to protect it from unauthorized interception.

Wi-Fi

Wireless Fidelity. Refers to an 802.11 wireless network.

WINS Resolution

Windows Internet Naming Service Resolution. Organizes the names of all Windows computers in a network with their respective IP addresses. Similar function to DNS.

Wireless Network Card

PCI or PCMCIA card that provides a computer with wireless access to a LAN via a WAP.

WPA2

Wi-Fi Protected Access. Security mechanism for wireless networks. Encrypts data to protect it from unauthorized interception. More secure than WEP.

XAZ

Cross-azimuth angle. Angle at which the antenna's RF feed assembly rotates to maintain the proper skew angle while tracking the satellite.



Appendix

E. Index

This section is an index to allow you to find information quickly.

Contents

Index.....	185
------------	-----

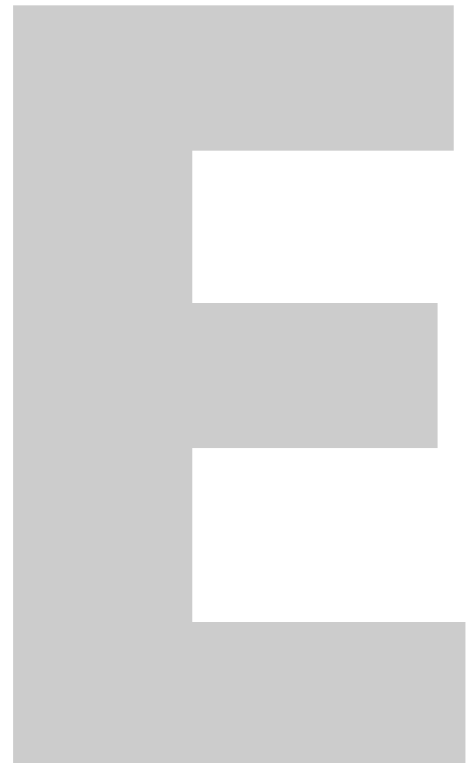

Index

A

- activation 15, 140
- administrator password 25
- alerts
 - data usage 93
- antenna
 - description 8
 - forward arrow 33, 45
 - pointing direction 19, 129
 - restart 155
 - serial number 140
 - software version 141
 - specifications 167
 - status 127, 134
- anti-virus software 102
- applications, data-intensive 99, 104
- automatic backup and sync, disabling 102
- automatic updates, preventing 102
- azimuth 129, 134, 167
- azimuth range, no-transmit zones 33
- azimuth range, tracking avoidance zones 45

B

- beam, satellite 133
- BitTorrent 104
- blockage, satellite 10, 116
- brightness 28

C

- cache settings 92
- cache, web browser 22, 103
- calling cards, prepaid 61
- calls
 - ship-to-shore 56
 - shore-to-ship 58
- channel, wireless 84
- cleaning 147
- clear cache 22

- cloud services, disabling 102
- CommBox software
 - description 106
 - Help 94
 - network settings 83, 91, 92, 94
 - purchasing 106
 - version 141
 - web interface 107
- Condensed Help 21
- corrective maintenance 154
- coverage map 9
- crew calling 61
- cumulative view, no-transmit zones 37, 49

D

- data allocations 75, 80
- data usage alerts 93
- data usage, reducing 101
- delay, voice call 56
- DHCP
 - Mac OS X 90
 - Windows 10 85
 - Windows 7 87
 - Windows 8 86
 - Windows Vista 87
 - Windows XP 88
- dial tone, fast 63
- dialing sequence 56

E

- electric shock 5
- elevation 129, 134, 167
- elevation range, no-transmit zones 34, 46
- e-mail, best practices 105
- emergency call 55
- End User Agreement 99, 104
- equipment ID numbers 15, 140
- error messages 121
- Ethernet ports 71
- event log 139
- Extended Help 21

F

- fax 65

- fax server 66
- field replaceable units 154
- firewall 103
- floating ground 5
- footprint, satellite 9
- frequency 133, 167
- front panel menus 163
- FRUs 154

G

- gain, antenna 167
- Gnutella 104
- GPRS modem
 - description 144
 - status 134
- GPS
 - backup 131
 - position 17, 19
 - source 135
 - status 135
- gyro stabilization 8

H

- hazard, radiation 6, 16
- heading 19, 135
- Help 21
- Help, CommBox 94
- Home page 19, 126
- HTS configurations
 - static IP HTS 77

I

- ICM
 - description 8
 - LEDs 136
 - serial number 140
 - software version 141
 - specifications 168
 - status 134

- IMAP 105
- incoming calls 58
- in-country call 56
- international call 56
- Internet access 99
- IP address
 - KVH support 130, 144
 - MTA 117
- iPhone/iPod touch app 152
- IP-MobileCast 82

L

- LAN settings 91
- latitude 130
- LCD brightness 28
- LCD menus 163
- LEDs 136
- lights, front panel 136
- log
 - event 139
 - operational 138
- login
 - CommBox software 107
 - crew 100
 - voice account 67
- longitude 130

M

- maintenance
 - corrective 154
 - preventative 147
- map, coverage 9
- Media Server 82
- menus, LCD 163
- mini-VSAT Broadband 7, 15
- mini-VSAT Manager 20
- mobile websites 104
- modem
 - description 8

- DID number 140
- initialization 17
- IP address 130
- satellite selection 11
- serial number 140
- software update 149
- software version 141
- status 133

MTA

- additional 60
- IP address 117
- MAC address 140
- restart 117, 155
- software version 141
- status 128

multimedia, disable 103

myKVH 20

N

network

- reset to factory 95
- settings 91
- status 133
- Wi-Fi 83

network configurations

- open access HTS 81
- selection 71
- standard HTS 74, 76
- static IP HTS 77

Network Operations Center 7

NMEA 0183 19, 135

no-transmit zones

- clear 39
- cumulative view 37, 49
- description 31
- disable 38
- range 17, 33, 34, 46
- setup 33
- status 32, 127

O

OneCare 142, 148

online 17

operational log 138

outgoing calls 56

P

- passphrase, WEP 84
- password
 - administrator 25
 - WPA2 84
- peer-to-peer file sharing 104
- phone line names 27
- phone lines, additional 59
- ping 119
- pointing direction, antenna 19, 129
- POP3 105
- pop-up blocker 103
- power
 - antenna 134
 - ICM 134
 - input 168
 - transmission (BUC) 167
- power on system 16
- preloading web pages, disabling 103
- preventative maintenance 147
- priority, voice traffic 55, 59
- Product Activation department 15
- PSTN 55

R

- radiation hazard 6, 16
- Real-time Vessel & VSAT Satellite Display 19
- remote monitoring 77
- remote service and support module
 - description 144
 - status 134
- reset, factory settings 95
- restart hardware 155
- RSS feeds 104

S

- safety 5
- satellite 7, 127, 133
- Satellite Airtime department 15
- satellite switching 11
- secure VPN 77

- security, wireless 84
- serial numbers 15, 140, 143
- SIP 55
- skew 129, 133, 134
- Skype 104
- SNR 127
- social media 104
- software update
 - description 149
 - via iPhone/iPod touch 152
 - via local computer 151
 - via satellite 150
 - via USB flash drive 153
- software versions 141
- specifications 167
- spyware 102
- SSID 84
- standard HTS configuration 74, 76
- startup sequence 17
- static IP HTS 77
- status information 126
- switch satellites 11

T

- technical support 143
- test web page 116
- tracking avoidance zones
 - allowance period 43
 - clear 51
 - description 43
 - disable 50
 - range 45
 - setup 44
- troubleshooting
 - basic 115
 - data problem 119
 - voice problem 117
- turn on system 16

U

- UCH-250 66
- USB flash drive 153
- user login 100

V

- vessel name 26
- virtual numbers 62
- voice service
 - account access 67
 - crew calling 61
 - delays 56
 - description 55
 - fax 65
 - fees 57
 - phone lines 59
 - priority 55, 59
 - ship-to-shore calls 56
 - shore-to-ship calls 58
 - status 128
 - virtual numbers 62
 - voicemail 63
- voicemail 63
- VoIP 55
- VPN, secure 77

W

- WAP 8, 71
- warnings 5
- web browser settings 103
- web interface access 18
- widgets 104
- Wi-Fi 71, 83
- Wi-Fi access, mobile devices 104
- wiring 159



www.kvh.com



KVH Industries A/S
EMEA Headquarters
Kokkedal, Denmark
Tel: +45 45 160 180 Fax: +45 45 160 181
E-mail: info@emea.kvh.com

KVH Industries, Inc.
World Headquarters
Middletown, RI U.S.A.
Tel: +1 401 847 3327 Fax: +1 401 849 0045
E-mail: info@kvh.com

KVH Industries Pte Ltd.
Asia-Pacific Headquarters
Singapore
Tel: +65 6513 0290 Fax: +65 6472 3469
E-mail: info@apac.kvh.com